

776437-4 ✓ ACTIVE

AMP | AMPSEAL 16

TE Internal #: 776437-4

Housing for Female Terminals, Wire-to-Wire, 12 Position, .177 in [4.5 mm] Centerline, Sealable, Green, Cable Mount (Free-Hanging), AMPSEAL 16

[View on TE.com >](#)



Connectors > Automotive Connectors > Automotive Housings > AMPSEAL 16 Housings



Connector System: **Wire-to-Wire**

Number of Positions: **12**

Connector & Housing Type: **Housing for Female Terminals**

Centerline (Pitch): **4.5 mm [ .177 in ]**

Sealable: **Yes**

[All AMPSEAL 16 Housings \(226\)](#)

## Features

### Product Type Features

Mixed & Hybrid Connector	No
Connector Shape	Rectangular
Connector System	Wire-to-Wire
Connector & Housing Type	Housing for Female Terminals
Sealable	Yes
Primary Locking Feature	Integrated in Housing

### Configuration Features

Number of Positions	12
Number of Rows	2

### Electrical Characteristics

Operating Voltage	250 VDC
Nominal Voltage Architecture	12 V, 24 V, 42 V, 48 V, 80 V, 90 V, 125 V, 240 V

### Body Features

Cable Exit Angle	180°
Primary Product Color	Green



Connector & Keying Code	4
-------------------------	---

### Contact Features

Contact Size	Size 16
--------------	---------

Contact Type	Socket
--------------	--------

Mating Pin Diameter	1.5 mm[.059 in]
---------------------	-----------------

Contact Current Rating (Max)	13 A
------------------------------	------

### Mechanical Attachment

Terminal Position Assurance	Yes
-----------------------------	-----

Strain Relief	Add By Accessory
---------------	------------------

Mating Alignment Type	Keyed
-----------------------	-------

Mating Alignment	With
------------------	------

Connector Mounting Type	Cable Mount (Free-Hanging)
-------------------------	----------------------------

### Housing Features

Housing Material	PBT GF
------------------	--------

Centerline (Pitch)	4.5 mm[.177 in]
--------------------	-----------------

### Dimensions

Connector Height	31.5 mm[1.24 in]
------------------	------------------

Product Width	36.8 mm[1.449 in]
---------------	-------------------

Product Length	38.33 mm[1.509 in]
----------------	--------------------

Row-to-Row Spacing	5.3 mm[.209 in]
--------------------	-----------------

### Usage Conditions

Operating Temperature (Max)	70 °C, 75 °C, 80 °C, 85 °C, 90 °C, 100 °C, 105 °C, 110 °C, 120 °C, 125 °C[158 °F][167 °F][176 °F][185 °F][194 °F][212 °F][221 °F][230 °F][248 °F][257 °F]
-----------------------------	---

Operating Temperature Range	-40 – 125 °C[-40 – 257 °F]
-----------------------------	----------------------------

### Industry Standards

Degree of Protection	IP67
----------------------	------

UL Flammability Rating	UL 94HB
------------------------	---------

### Packaging Features

Packaging Quantity	14
--------------------	----

Packaging Method	Package
------------------	---------

### Other



Serviceable	Yes
Connector Position Assurance Capable	Yes

### Product Compliance

[For compliance documentation, visit the product page on TE.com>](#)

EU RoHS Directive 2011/65/EU	Compliant
EU ELV Directive 2000/53/EC	Compliant
China RoHS 2 Directive MIIT Order No 32, 2016	No Restricted Materials Above Threshold
EU REACH Regulation (EC) No. 1907/2006	<p>Current ECHA Candidate List: JUNE 2023 (235)                      Candidate List Declared Against: JUNE 2023 (235)                      SVHC &gt; Threshold:                      Octamethylcyclotetrasiloxane (D4) (.5% in Component Part)                      Dodecamethylcyclohexasiloxane (D6) (.5% in Component Part)                      Decamethylcyclopentasiloxane (D5) (.5% in Component Part)</p> <p><b>Article Safe Usage Statements:</b>                      Wash thoroughly after handling. Recycle if possible and dispose of the article by following all applicable governmental regulations relevant to your geographic location.</p>
Halogen Content	BFR/CFR/PVC Free, but Br/Cl >900 ppm in other sources.
Solder Process Capability	Not applicable for solder process capability

#### Product Compliance Disclaimer

This information is provided based on reasonable inquiry of our suppliers and represents our current actual knowledge based on the information they provided. This information is subject to change. The part numbers that TE has identified as EU RoHS compliant have a maximum concentration of 0.1% by weight in homogenous materials for lead, hexavalent chromium, mercury, PBB, PBDE, DBP, BBP, DEHP, DIBP, and 0.01% for cadmium, or qualify for an exemption to these limits as defined in the Annexes of Directive 2011/65/EU (RoHS2). Finished electrical and electronic equipment products will be CE marked as required by Directive 2011/65/EU. Components may not be CE marked. Additionally, the part numbers that TE has identified as EU ELV compliant have a maximum concentration of 0.1% by weight in homogenous materials for lead, hexavalent chromium, and mercury, and 0.01% for cadmium, or qualify for an exemption to these limits as defined in the Annexes of Directive 2000/53/EC (ELV). Regarding the REACH Regulation, the information TE provides on SVHC in articles for this part number is based on the latest European Chemicals Agency (ECHA) 'Guidance on requirements for substances in articles' posted at this URL: <https://echa.europa.eu/guidance-documents/guidance-on-reach>

### Compatible Parts



Also in the Series | AMPSEAL 16

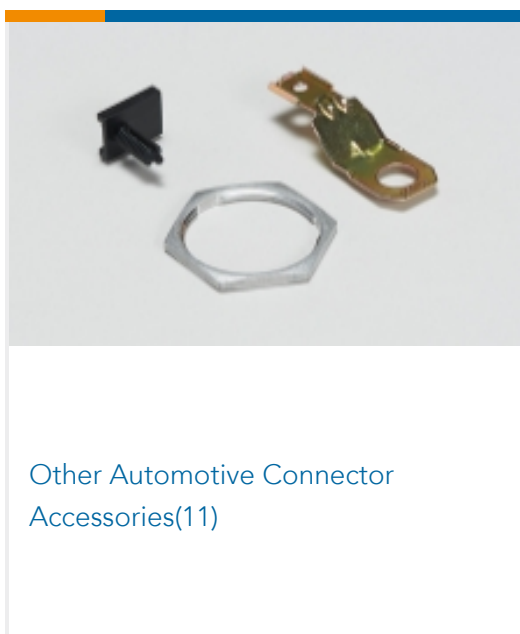
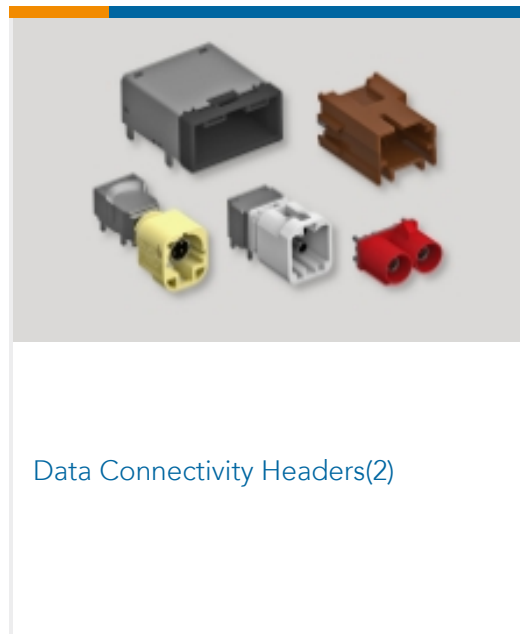
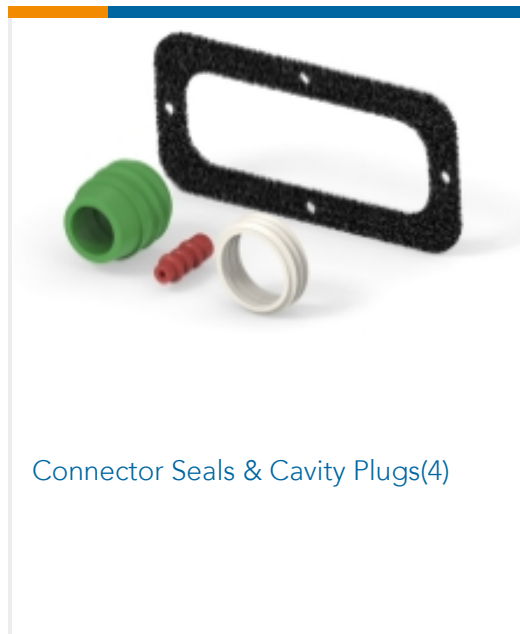
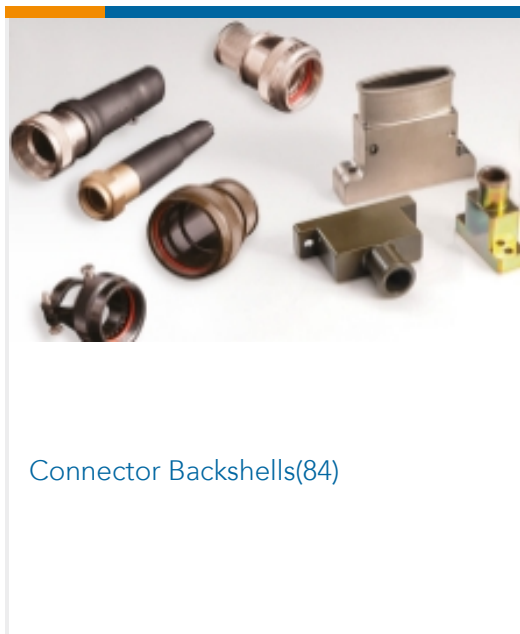
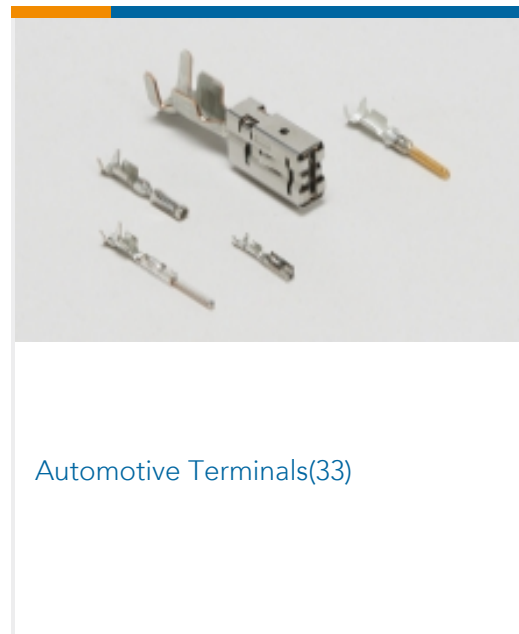
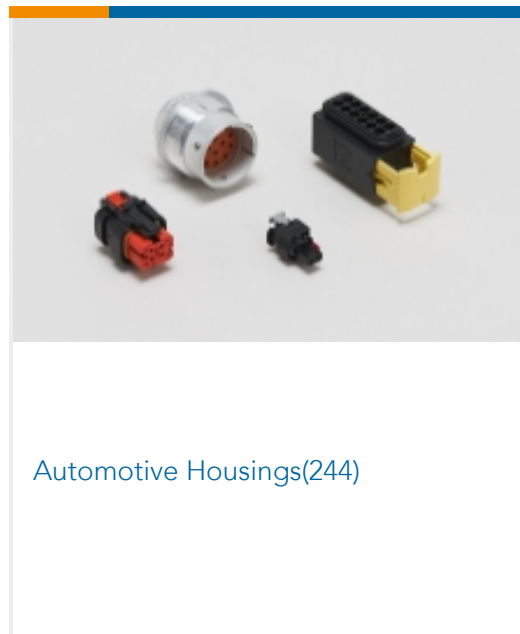
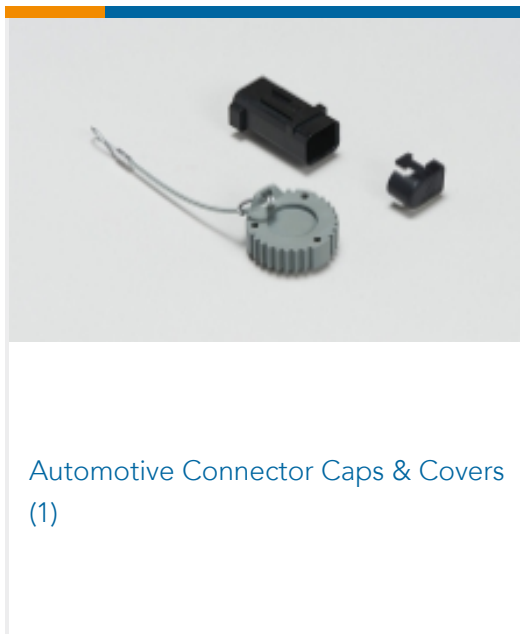

Customers Also Bought

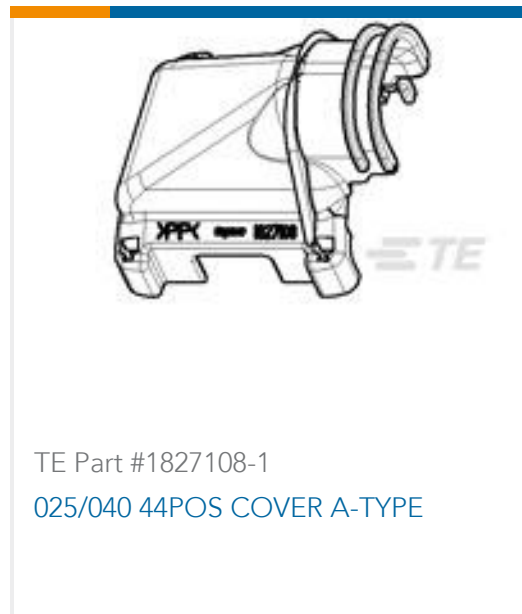

## Documents

### Product Drawings

[AS 16, 12P PLUG ASSY, KEY 4](#)

English

### CAD Files

[3D PDF](#)

3D

Customer View Model

[ENG\\_CVM\\_CVM\\_776437-4\\_E\\_c-776437-4-e.2d\\_dxf.zip](#)

English

Customer View Model

[ENG\\_CVM\\_CVM\\_776437-4\\_E\\_c-776437-4-e.3d\\_igs.zip](#)

English

Customer View Model

[ENG\\_CVM\\_CVM\\_776437-4\\_E\\_c-776437-4-e.3d\\_stp.zip](#)

English

By downloading the CAD file I accept and agree to the [Terms and Conditions](#) of use.

### Datasheets & Catalog Pages

[ICT Terminals and Connectors Catalogue](#)

English

[CONNECTOR SELECTOR](#)

English

### Product Specifications

[Application Specification](#)

English



776437-4

Housing for Female Terminals, Wire-to-Wire, 12 Position, .177 in [4.5 mm] Centerline, Sealable, Green, Cable Mount (Free-Hanging), AMPSEAL 16



[Instruction Sheets](#)

[Instruction Sheet \(U.S.\)](#)

English