

October 1997

Features

- 50A, 60V
- $r_{DS(ON)} = 0.022\Omega$
- *Temperature Compensating PSPICE Model*
- *Peak Current vs Pulse Width Curve*
- *UIS Rating Curve*
- *175°C Operating Temperature*
- *Related Literature*
 - TB334, "Guidelines for Soldering Surface Mount Components to PC Boards"

Ordering Information

PART NUMBER	PACKAGE	BRAND
RFG50N06	TO-247	RFG50N06
RFP50N06	TO-220AB	RFP50N06
RF1S50N06	TO-262AA	F1S50N06
RF1S50N06SM	TO-263AB	F1S50N06

NOTE: When ordering, use the entire part number. Add the suffix, 9A, to obtain the TO-263AB variant in tape and reel, i.e. RF1S50N06SM9A.

Description

These N-Channel power MOSFETs are manufactured using the MegaFET process. This process, which uses feature sizes approaching those of LSI integrated circuits gives optimum utilization of silicon, resulting in outstanding performance. They were designed for use in applications such as switching regulators, switching converters, motor drivers, and relay drivers. These transistors can be operated directly from integrated circuits.

Formerly developmental type TA49018.

Symbol

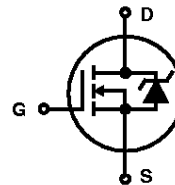

Packaging

JEDEC STYLE TO-247

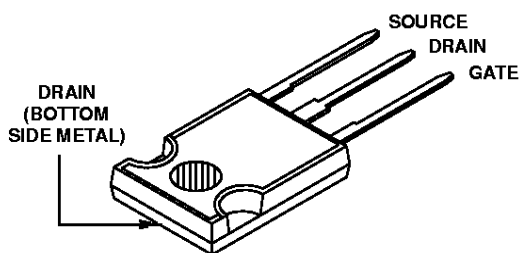

JEDEC TO-220AB

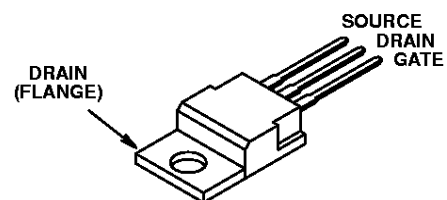

JEDEC TO-262AA

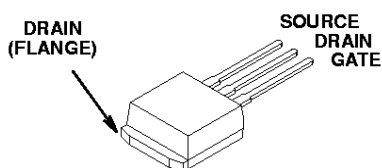

JEDEC TO-263AB

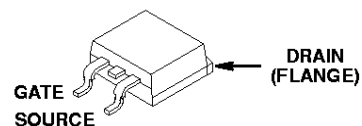

RFG50N06, RFP50N06, RF1S50N06, RF1S50N06SM

Absolute Maximum Ratings $T_C = 25^\circ\text{C}$, Unless Otherwise Specified

	RFG50N06, RFP50N06 RF1S50N06, RF1S50N06SM	UNITS
Drain to Source Voltage (Note 1)	60	V
Drain to Gate Voltage ($R_{GS} = 20\text{k}\Omega$) (Note 1)	60	V
Gate to Source Voltage	± 20	V
Continuous Drain Current (Figure 2)	50	A
Pulsed Drain Current	(Figure 5)	
Pulsed Avalanche Rating	(Figure 6, 14, 15)	
Power Dissipation	131	W
Linear Derating Factor	0.877	W/ $^\circ\text{C}$
Operating and Storage Temperature	-55 to 175	$^\circ\text{C}$
Maximum Temperature for Soldering		
Leads at 0.063in (1.6mm) from Case for 10s	300	$^\circ\text{C}$
Package Body for 10s, see Techbrief 334	260	$^\circ\text{C}$

CAUTION: Stresses above those listed in "Absolute Maximum Ratings" may cause permanent damage to the device. This is a stress only rating and operation of the device at these or any other conditions above those indicated in the operational sections of this specification is not implied.

NOTE:

1. $T_J = 25^\circ\text{C}$ to 150°C .

Electrical Specifications $T_C = 25^\circ\text{C}$, Unless Otherwise Specified

PARAMETER	SYMBOL	TEST CONDITIONS	MIN	TYP	MAX	UNITS	
Drain to Source Breakdown Voltage	BV_{DSS}	$I_D = 250\mu\text{A}$, $V_{GS} = 0\text{V}$ (Figure 11)	60	-	-	V	
Gate to Source Threshold Voltage	$V_{GS(TH)}$	$V_{GS} = V_{DS}$, $I_D = 250\mu\text{A}$ (Figure 10)	2	-	4	V	
Zero Gate Voltage Drain Current	I_{DSS}	$V_{DS} = 60\text{V}$, $V_{GS} = 0\text{V}$	$T_C = 25^\circ\text{C}$	-	1	μA	
			$T_C = 150^\circ\text{C}$	-	50	μA	
Gate to Source Leakage Current	I_{GSS}	$V_{GS} = \pm 20\text{V}$	-	-	± 100	nA	
Drain to Source On Resistance	$r_{DS(ON)}$	$I_D = 50\text{A}$, $V_{GS} = 10\text{V}$ (Figures 9)	-	-	0.022	Ω	
Turn-On Time	t_{ON}	$V_{DD} = 30\text{V}$, $I_D = 50\text{A}$ $R_L = 0.6\Omega$, $V_{GS} = 10\text{V}$ $R_{GS} = 3.6\Omega$ (Figures 16, 17)	-	-	95	ns	
Turn-On Delay Time	$t_{d(ON)}$		-	12	-	ns	
Rise Time	t_r		-	55	-	ns	
Turn-Off Delay Time	$t_{d(OFF)}$		-	37	-	ns	
Fall Time	t_f		-	13	-	ns	
Turn-Off Time	t_{OFF}		-	-	75	ns	
Total Gate Charge	$Q_g(TOT)$	$V_{GS} = 0$ to 20V	$V_{DD} = 48\text{V}$, $I_D = 50\text{A}$, $R_L = 0.96\Omega$ (Figures 13, 18, 19)	-	125	150	nC
Gate Charge at 10V	$Q_g(10)$	$V_{GS} = 0$ to 10V		-	67	80	nC
Threshold Gate Charge	$Q_g(TH)$	$V_{GS} = 0$ to 2V		-	3.7	4.5	nC
Input Capacitance	C_{ISS}	$V_{DS} = 25\text{V}$, $V_{GS} = 0\text{V}$ $f = 1\text{MHz}$ (Figure 12)	-	2020	-	pF	
Output Capacitance	C_{OSS}		-	600	-	pF	
Reverse Transfer Capacitance	C_{RSS}		-	200	-	pF	
Thermal Resistance Junction to Case	$R_{\theta JC}$	(Figure 3)	-	-	1.14	$^\circ\text{C/W}$	
Thermal Resistance Junction to Ambient	$R_{\theta JA}$	TO-247	-	-	30	$^\circ\text{C/W}$	
		TO-220, TO-262, TO-263	-	-	62	$^\circ\text{C/W}$	

Source to Drain Diode Specifications

PARAMETER	SYMBOL	TEST CONDITIONS	MIN	TYP	MAX	UNITS
Source to Drain Diode Voltage	V_{SD}	$I_{SD} = 50\text{A}$	-	-	1.5	V
Reverse Recovery Time	t_{rr}	$I_{SD} = 50\text{A}$, $dI_{SD}/dt = 100\text{A}/\mu\text{s}$	-	-	125	ns

Typical Performance Curves Unless Otherwise Specified

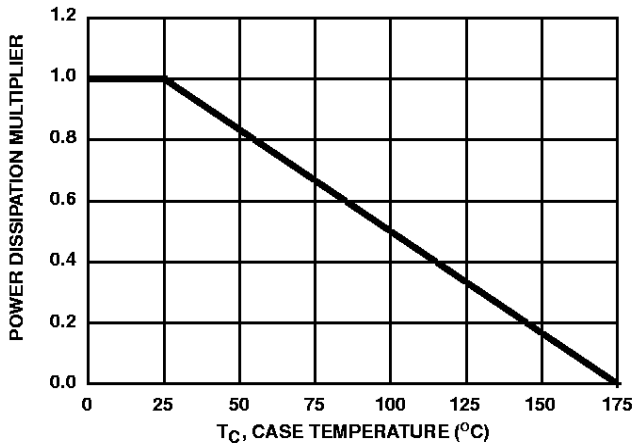

FIGURE 1. NORMALIZED POWER DISSIPATION vs CASE TEMPERATURE

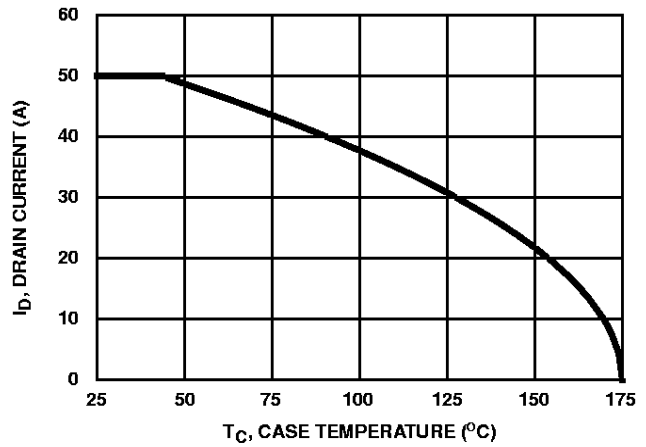

FIGURE 2. MAXIMUM CONTINUOUS DRAIN CURRENT vs CASE TEMPERATURE

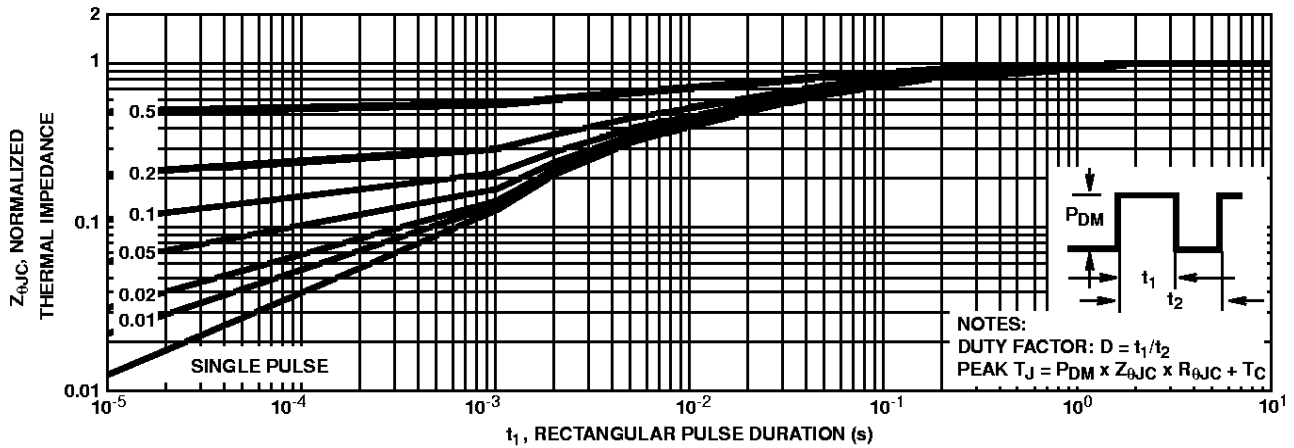

FIGURE 3. NORMALIZED MAXIMUM TRANSIENT THERMAL IMPEDANCE

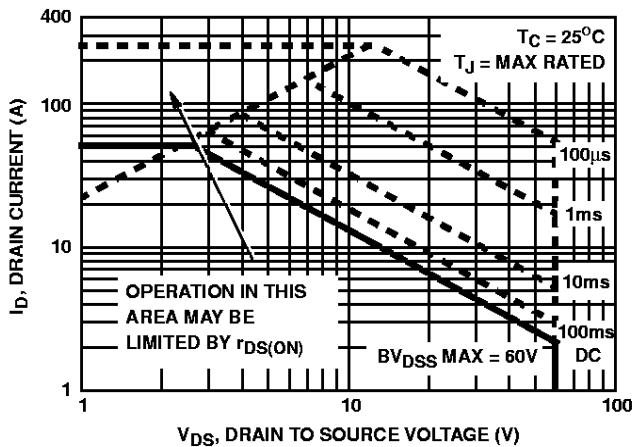

FIGURE 4. FORWARD BIAS SAFE OPERATING AREA

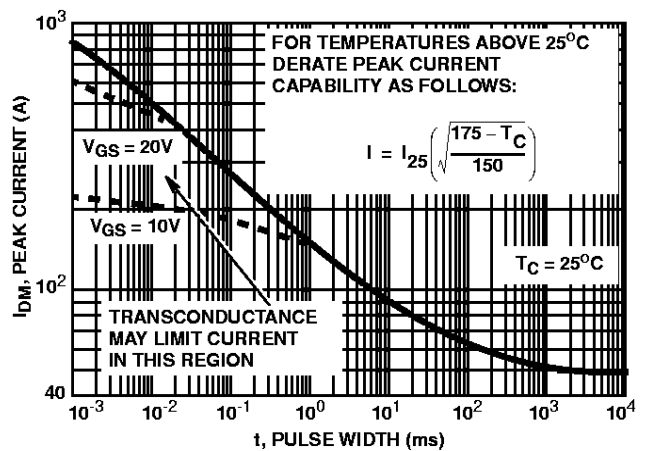
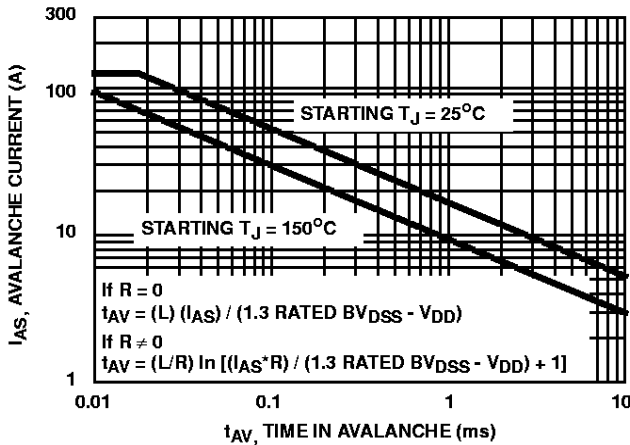

FIGURE 5. PEAK CURRENT CAPABILITY

Typical Performance Curves Unless Otherwise Specified (Continued)



NOTE: Refer to Harris Application Notes 9321 and 9322.

FIGURE 6. UNCLAMPED INDUCTIVE SWITCHING CAPABILITY

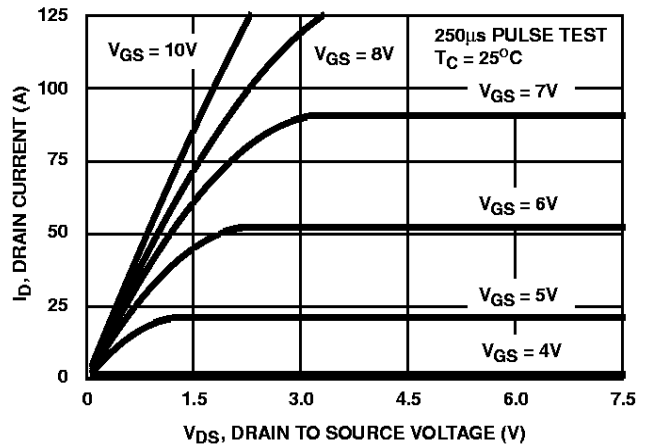

FIGURE 7. SATURATION CHARACTERISTICS

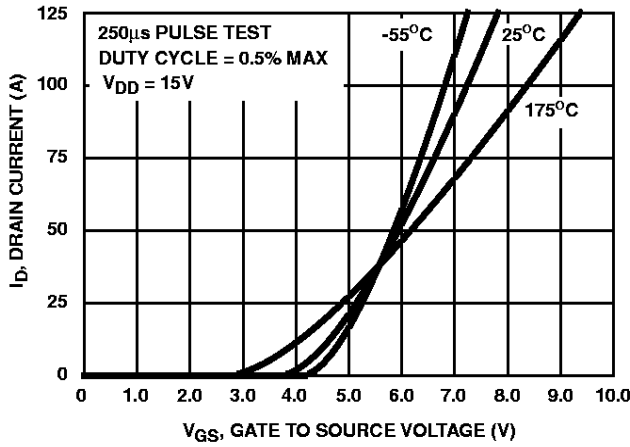

FIGURE 8. TRANSFER CHARACTERISTICS

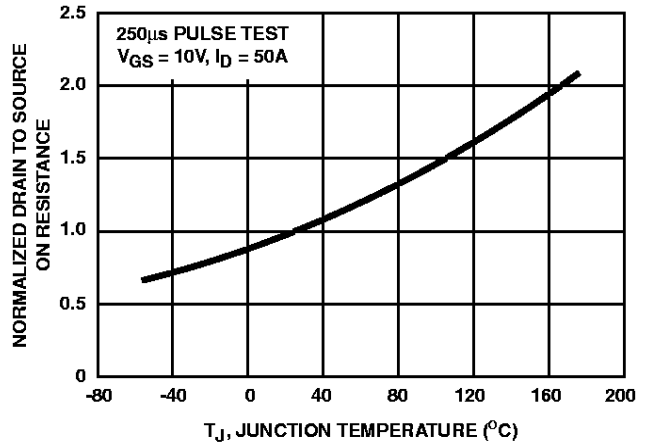

FIGURE 9. NORMALIZED DRAIN TO SOURCE ON RESISTANCE vs JUNCTION TEMPERATURE

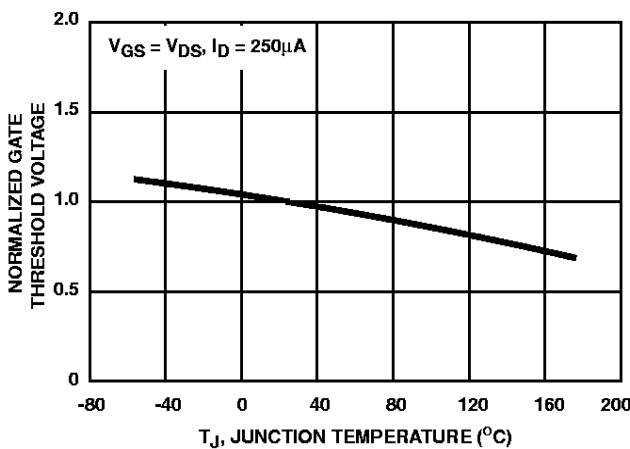

FIGURE 10. NORMALIZED GATE THRESHOLD VOLTAGE vs JUNCTION TEMPERATURE

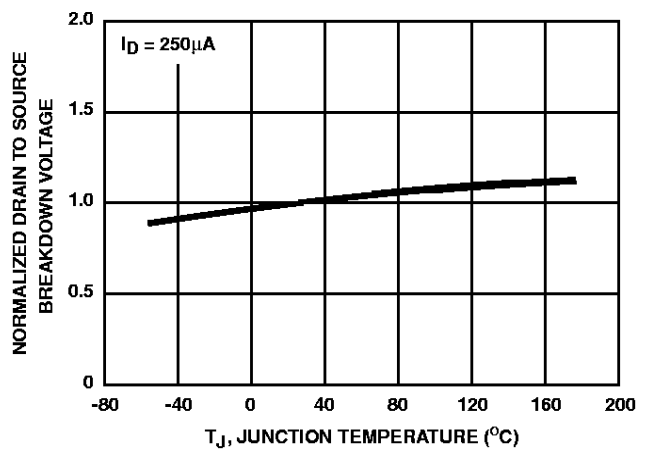

FIGURE 11. NORMALIZED DRAIN TO SOURCE BREAKDOWN VOLTAGE vs JUNCTION TEMPERATURE

Typical Performance Curves Unless Otherwise Specified (Continued)

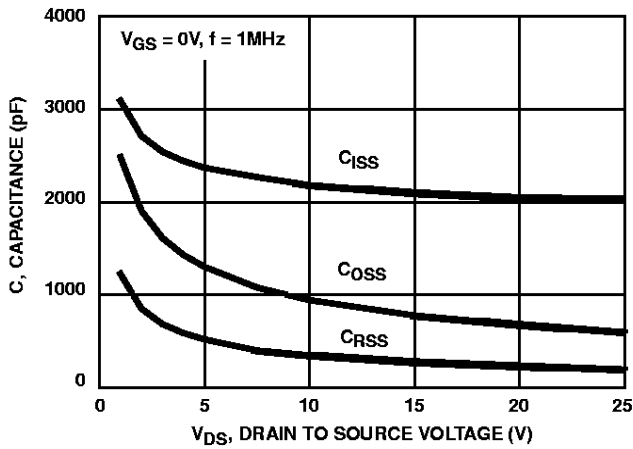
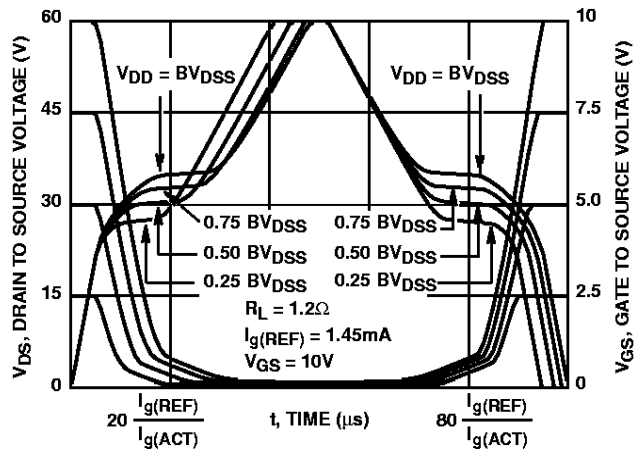

FIGURE 12. CAPACITANCE vs DRAIN TO SOURCE VOLTAGE



NOTE: Refer to Harris Application Notes 7254 and 7260.

FIGURE 13. NORMALIZED SWITCHING WAVEFORMS FOR CONSTANT GATE CURRENT

Test Circuits and Waveforms

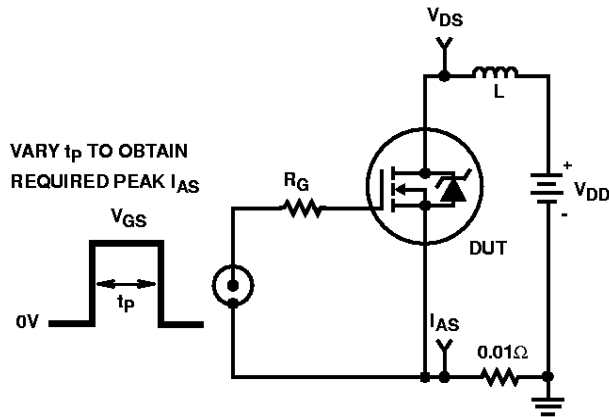

FIGURE 14. UNCLAMPED ENERGY TEST CIRCUIT

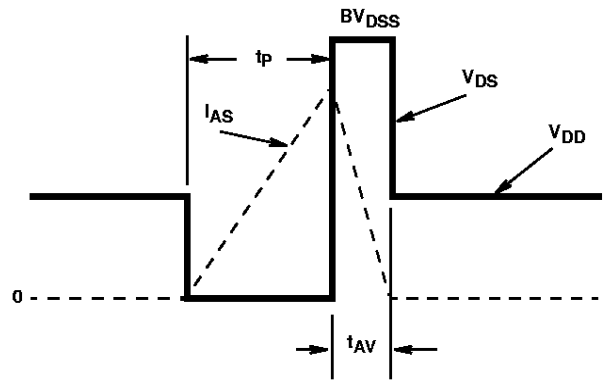

FIGURE 15. UNCLAMPED ENERGY WAVEFORMS

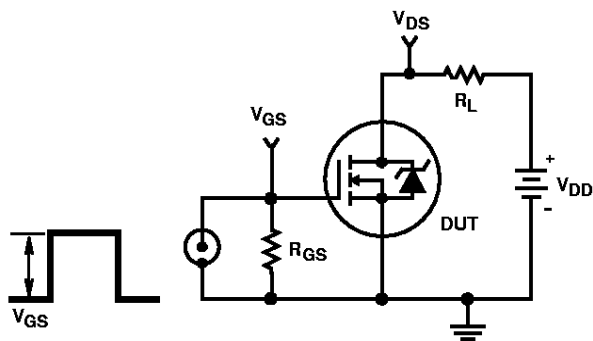

FIGURE 16. SWITCHING TIME TEST CIRCUIT

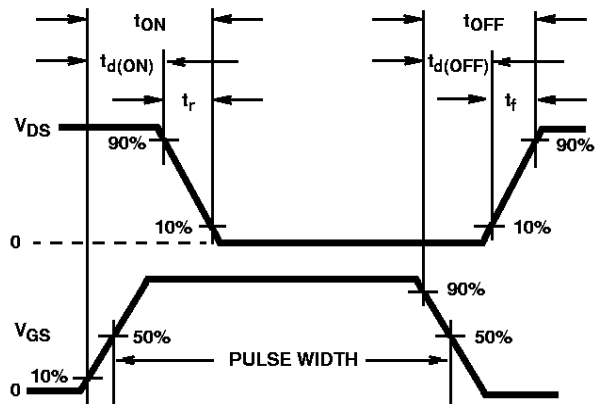

FIGURE 17. SWITCHING WAVEFORMS

Test Circuits and Waveforms (Continued)

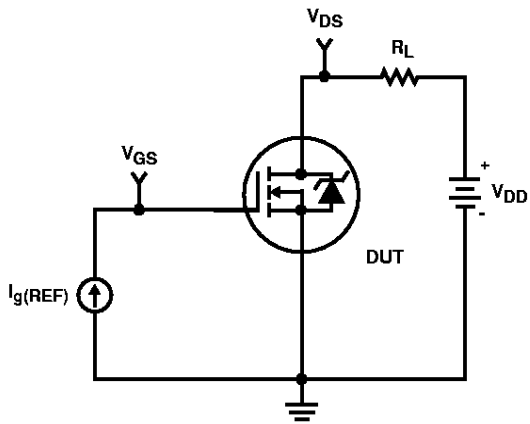

FIGURE 18. GATE CHARGE TEST CIRCUIT

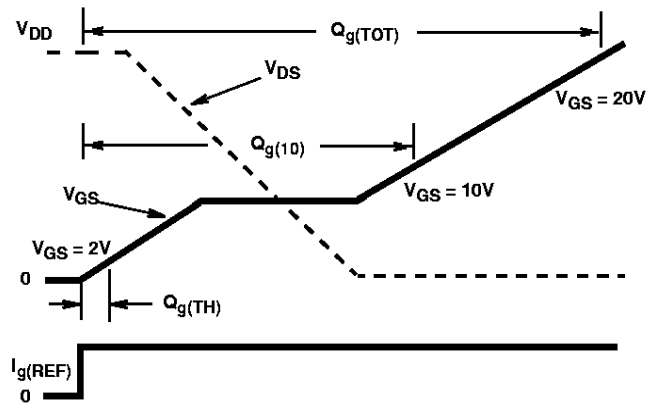

FIGURE 19. GATE CHARGE WAVEFORMS

RFG50N06, RFP50N06, RF1S50N06, RF1S50N06SM

PSPICE Electrical Model

.SUBCKT RFP50N06 2 1 3

REV 2/22/93

*NOM TEMP = 25°C

CA 12 8 3.68e-9
 CB 15 14 3.625e-9
 CIN 6 8 1.98e-9

DBODY 7 5 DBDMOD
 DBREAK 5 11 DBKMOD
 DPLCAP 10 5 DPLCAPMOD

EBREAK 11 7 17 18 64.59
 EDS 14 8 5 8 1
 EGS 13 8 6 8 1
 ESG 6 10 6 8 1
 EVTO 20 6 18 8 1

IT 8 17 1

LDRAIN 2 5 1e-9
 LGATE 1 9 5.65e-9
 LSOURCE 3 7 4.13e-9

MOS1 16 6 8 8 MOSMOD M=0.99
 MOS2 16 21 8 8 MOSMOD M=0.01

RBREAK 17 18 RBKMOD 1
 RDRAIN 5 16 RDSMOD 1e-4
 RGATE 9 20 0.690
 RIN 6 8 1e9
 RSOURCE 8 7 RDSMOD 12e-3
 RVTO 18 19 RVTOMOD 1

S1A 6 12 13 8 S1AMOD
 S1B 13 12 13 8 S1BMOD
 S2A 6 15 14 13 S2AMOD
 S2B 13 15 14 13 S2BMOD

VBAT 8 19 DC 1
 VTO 21 6 0.678

.MODEL DBDMOD D (IS=9.85e-13 RS=4.91e-3 TRS1=2.07e-3 TRS2=2.51e-7 CJO=2.05e-9 TT=4.33e-8)
 .MODEL DBKMOD D (RS=1.98e-1 TRS1=2.35E-4 TRS2=-3.83e-6)
 .MODEL DPLCAPMOD D (CJO=1.42e-9 IS=1e-30 N=10)
 .MODEL MOSMOD NMOS (VTO=3.65 KP=35 IS=1e-30 N=10 TOX=1 L=1u W=1u)
 .MODEL RBKMOD RES (TC1=1.23e-3 TC2=-2.34e-7)
 .MODEL RDSMOD RES (TC1=5.01e-3 TC2=1.49e-5)
 .MODEL RVTOMOD RES (TC1=-5.03e-3 TC2=-5.16e-6)
 .MODEL S1AMOD VSWITCH (RON=1e-5 ROFF=0.1 VON=-6.75 VOFF=-2.5)
 .MODEL S1BMOD VSWITCH (RON=1e-5 ROFF=0.1 VON=-2.5 VOFF=-6.75)
 .MODEL S2AMOD VSWITCH (RON=1e-5 ROFF=0.1 VON=-2.7 VOFF=2.3)
 .MODEL S2BMOD VSWITCH (RON=1e-5 ROFF=0.1 VON=2.3 VOFF=-2.7)

.ENDS

NOTE: For further discussion of the PSPICE model consult **A New PSPICE Sub-Circuit for the Power MOSFET Featuring Global Temperature Options**; authors, William J. Hepp and C. Frank Wheatley.

