

## Data sheet | Item number: 770-124

Socket; with strain relief housing; 4-pole; Cod. A; 4,00 mm<sup>2</sup>; white

[www.wago.com/770-124](http://www.wago.com/770-124)

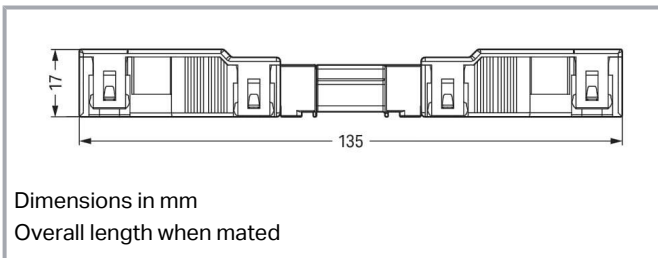
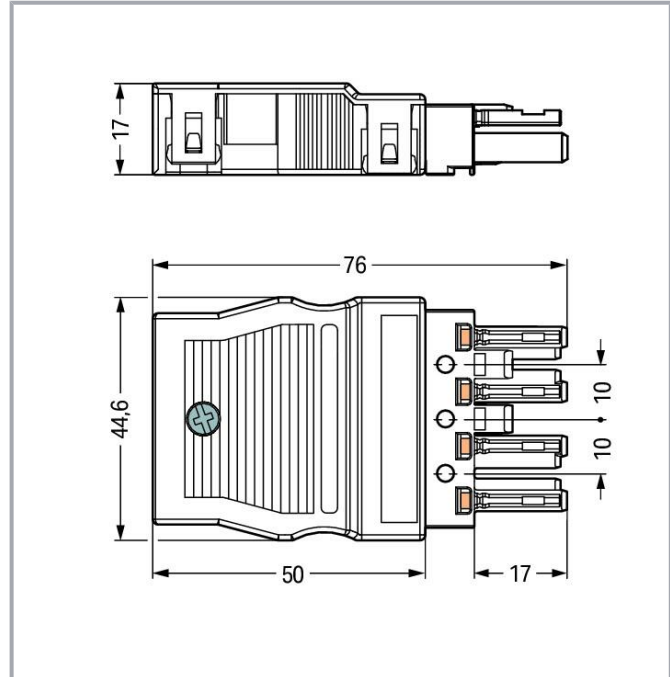
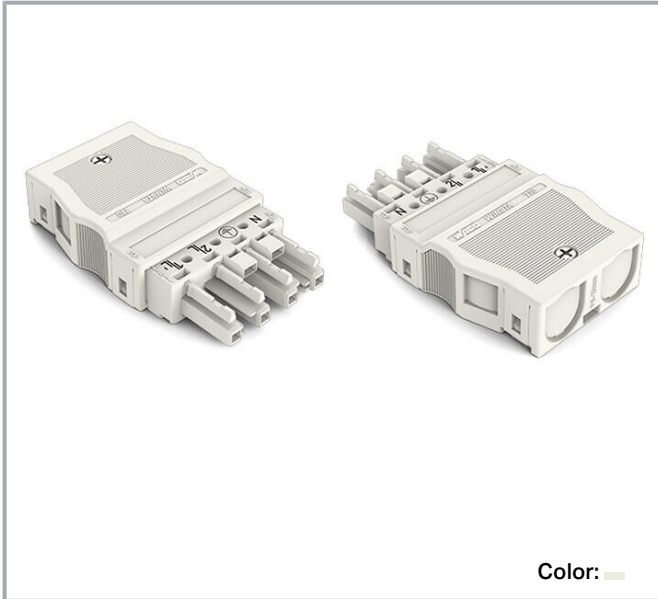

### Item description

#### Female connector/socket *WINSTA*® MIDI A coding

Use effective pluggable connections instead of laborious screw connections: With the *WINSTA*® MIDI female connector/socket with protection against mismatching. The pluggable installation connectors with spring pressure connection technology function entirely without screw connections. They allow resource-efficient, error-free installation in numerous applications. The mechanical coding and color coding of the pluggable installation connector ensure error-free installation of the individual components – including protection against mismatching. The pluggable installation connector offers protection against contact with live components in accordance with protection type IP20 (When mated and secured with a strain relief housing: IP2xC (These compact connectors are not designed for use in open, easily accessible areas!)). The *WINSTA*® MIDI pluggable installation

Subject to changes. Please also observe the further product documentation!

WAGO GmbH & Co. KG  
Hansastr. 27  
32423 Minden  
Phone: +49571 887-0 | Fax: +49571 887-169  
Email: [info.de@wago.com](mailto:info.de@wago.com) | Web: [www.wago.com](http://www.wago.com)

Do you have any questions about our products?  
We are always happy to take your call at +49 (571) 887-44222.



connector with A coding in black or white is usually used for general mains applications in power distribution. Important parameters in the selection of a pluggable installation connector are the rated current and voltage: They tell us about the product's domains of use. This product has a current rating of 25 A – therefore it is suitable for high power loads. The WINSTA® MIDI product line allows total flexibility for the electrical installation. With its Push-in CAGE CLAMP® spring pressure connection technology, it ensures error-free, time-saving installation and offers customization and flexibility for meeting an enormous variety of installation requirements. The strip length is 55 mm.

### Lower costs through fast commissioning and elimination of service expenses – solutions from WINSTA® MIDI

The WINSTA® Pluggable Connection System allows pluggable electrical installation. This saves time, lowers costs, and reduces the need for servicing. Now you can also cut installation costs without compromising safety and quality: with protection against mismatching reduces the need for servicing and prevents unnecessary downtime.

- pluggable installation connectors with protection against mismatching
- pre-assembled versions
- for any mains application
- ready for immediate use
- convenient installation and commissioning

## Data

### Electrical data

#### Ratings per IEC/EN

Ratings per	IEC/EN 60664-1
Nominal voltage (III/3)	400 V
Rated impulse voltage (III/3)	6 kV
Rated current	25 A
Legend (ratings)	(III / 3) ≙ Overvoltage category III / Pollution degree 3

#### Ratings per UL 1977

Note for the US market	Some versions may also be used for current interruption in accordance with the UL certificate in select applications with currents below 16 A and voltages up to 600 V. For further information, please contact your local sales office.
Rated voltage (UL 1977)	600 V
Rated current UL 1977	23 A

Subject to changes. Please also observe the further product documentation!



## General information

Note on contact resistance	approx. 1 mΩ of contact resistance approx. 0.25 mΩ contact transition plug/socket
----------------------------	--

## Connection data

Connection points	8
Total number of potentials	4

## Connection 1

Connection technology	Push-in CAGE CLAMP®
Actuation type	Operating tool Push-in
Nominal cross-section	4 mm <sup>2</sup> / 12 AWG
Solid conductor	0.5 ... 4 mm <sup>2</sup> / 20 ... 12 AWG
Solid conductor; push-in termination	1.5 ... 4 mm <sup>2</sup> / 16 ... 12 AWG
Stranded conductor	0.5 ... 2.5 mm <sup>2</sup> / 20 ... 14 AWG
Fine-stranded conductor	0.5 ... 4 mm <sup>2</sup> / 20 ... 12 AWG
Fine-stranded conductor; with insulated ferrule	0.25 ... 1.5 mm <sup>2</sup> / 20 ... 16 AWG
Fine-stranded conductor; with uninsulated ferrule	0.25 ... 2.5 mm <sup>2</sup> / 20 ... 14 AWG
Fine-stranded conductor; with ferrule; push-in termination	1.5 mm <sup>2</sup> / 16 AWG
Strip length	9 mm / 0.35 inches
Pole number	4
Conductor entry direction to mating direction	0°
Strip length (outer insulation)	55 mm

## Physical data

Pin spacing	10 mm / 0.394 inches
Width	44.6 mm / 1.756 inches
Height	17 mm / 0.669 inches
Depth	76 mm / 2.992 inches

## Mechanical Data

Application	General mains applications
Coding	A
Variable coding	Yes

Subject to changes. Please also observe the further product documentation!

WAGO GmbH & Co. KG  
Hansastr. 27  
32423 Minden  
Phone: +49571 887-0 | Fax: +49571 887-169  
Email: [info.de@wago.com](mailto:info.de@wago.com) | Web: [www.wago.com](http://www.wago.com)

Do you have any questions about our products?  
We are always happy to take your call at +49 (571) 887-44222.



Marking	N $\downarrow$ 2/L 1/L'
Potential marking	N $\downarrow$ 2/L 1/L'
Mating force of a plug-in connection	approx. 20 ... 70 N (depending on pole number)
Retention force of a plug-in connection	Locked: > 80 N
Unmating force of a plug-in connection	Unlocked: approx. 20 ... 70 N (depending on pole number)
Number of mating cycles	200, without resistive load
Protection type	IP20; When mated and secured with a strain relief housing: IP2xC (These compact connectors are not designed for use in open, easily accessible areas!)

### Plug-in connection

Contact type (pluggable connector)	Female connector/socket
Connector (connection type)	for conductor
Mismating protection	Yes
Note on mismating protection	All WINSTA <sup>®</sup> components are 100% protected against mismating when: a.) plugging different numbers of poles b.) plugging while rotated 180 c.) plugging while laterally staggered d.) plugging one pole
Locking lever	Can be retrofitted
Locking of plug-in connection	locking lever
Note on locking system	All connectors for mounted installations (snap-in versions for lighting fixtures or devices, all types of PCB and distribution connectors) are factory-equipped with locking levers to ensure plugs and sockets are securely locked. Additional locking levers are only required for flying leads (plug/socket).
Strain relief	strain relief housing

### Material data

Note (material data)	Information on material specifications can be found <a href="#">here</a>
Color	white
Cover color	gray
Material group	I
Insulation material	Polyamide (PA66)
Flammability class per UL94	V0
Clamping spring material	Chrome-nickel spring steel (CrNi)
Contact material	Copper or copper alloy; surface-treated

Subject to changes. Please also observe the further product documentation!

Contact plating	Tin
Fire load	0.549 MJ
Weight	24.5 g

### Environmental requirements

Processing temperature	-5 ... +40 °C
Continuous operating temperature	-35 ... +85 °C
Note on continuous operating temperature	Insulating parts for temperatures $\leq 105$ °C

### Commercial data

Product Group	20 (Winsta)
eCl@ss 10.0	27-44-06-05
eCl@ss 9.0	27-44-06-05
ETIM 8.0	EC002560
ETIM 7.0	EC002560
ECCN	NO DATA
PU (SPU)	25 pcs
Packaging type	box
Country of origin	DE
GTIN	4044918252188
Customs tariff number	85366990990

### Environmental Product Compliance

RoHS Compliance Status	Compliant, No Exemption
------------------------	-------------------------

### Approvals / Certificates

#### General approvals

Logo	Approval	Additional Approval Text	Certificate name
	CCA DEKRA Certification B.V.	EN 61535	71-123228
	CCA DEKRA Certification B.V.	IEC 61535	NL -84761
	cURus Underwriters Laboratories Inc.	UL 1977	E45171

Subject to changes. Please also observe the further product documentation!



cURus

UL 1059

E 45172



Underwriters Laboratories Inc.



VDE

EN 61535

40029808

VDE Prüf- und Zertifizierungsinstitut



VDE

EN 61984



40002889

VDE Prüf- und Zertifizierungsinstitut

## Declarations of conformity and manufacturer's declarations

Logo	Approval	Additional Approval Text	Certificate name
	EU-Declaration of Conformity WAGO GmbH & Co. KG	-	-

## Approvals for marine applications

Logo	Approval	Additional Approval Text	Certificate name
	ABS American Bureau of Shipping	-	19- HG1868589- PDA
	DNV GL Det Norske Veritas, Germanischer Lloyd	-	TAE00001Z6
	LR Lloyds Register	IEC 61984	LR22429487TA

Subject to changes. Please also observe the further product documentation!

WAGO GmbH &amp; Co. KG

Hansastr. 27

32423 Minden













Phone: +49571 887-0 | Fax: +49571 887-169

Email: [info.de@wago.com](mailto:info.de@wago.com) | Web: [www.wago.com](http://www.wago.com)

Do you have any questions about our products?

We are always happy to take your call at +49 (571) 887-44222.

## Counterpart

	<b>Item no.770-134</b> Plug; with strain relief housing; 4-pole; Cod. A; 4,00 mm <sup>2</sup> ; white	<a href="http://www.wago.com/770-134">www.wago.com/770-134</a>
	<b>Item no.770-234</b> Plug; 4-pole; Cod. A; 4,00 mm <sup>2</sup> ; white	<a href="http://www.wago.com/770-234">www.wago.com/770-234</a>
	<b>Item no.770-6224</b> Linect <sup>®</sup> T-connector; 4-pole; Cod. A; 1 input; 2 outputs; white	<a href="http://www.wago.com/770-6224">www.wago.com/770-6224</a>
	<b>Item no.770-676</b> T-distribution connector; 4-pole; Cod. A; 1 input; 2 outputs; 2 locking levers; white	<a href="http://www.wago.com/770-676">www.wago.com/770-676</a>
	<b>Item no.770-677</b> T-distribution connector; 4-pole; Cod. A; 1 input; 2 outputs; 3 locking levers; for flying leads; white	<a href="http://www.wago.com/770-677">www.wago.com/770-677</a>
	<b>Item no.770-734</b> Snap-in plug; 4-pole; Cod. A; 4,00 mm <sup>2</sup> ; white	<a href="http://www.wago.com/770-734">www.wago.com/770-734</a>
	<b>Item no.770-734/007-000</b> Snap-in plug; with direct ground contact; 4-pole; Cod. A; 4,00 mm <sup>2</sup> ; white	<a href="http://www.wago.com/770-734/007-000">www.wago.com/770-734/007-000</a>
	<b>Item no.770-834</b> Plug for PCBs; straight; 4-pole; Cod. A; white	<a href="http://www.wago.com/770-834">www.wago.com/770-834</a>
	<b>Item no.770-834/011-000</b> Plug for PCBs; angled; 4-pole; Cod. A; white	<a href="http://www.wago.com/770-834/011-000">www.wago.com/770-834/011-000</a>
	<b>Item no.770-994</b> h-distribution connector; 4-pole; Cod. A; 1 input; 2 outputs; outputs on one side; 2 locking levers; white	<a href="http://www.wago.com/770-994">www.wago.com/770-994</a>
	<b>Item no.770-995</b> h-distribution connector; 4-pole; Cod. A; 1 input; 2 outputs; outputs on one side; 3 locking levers; for flying leads; white	<a href="http://www.wago.com/770-995">www.wago.com/770-995</a>
	<b>Item no.771-9994/206-102</b> pre-assembled connecting cable; Eca; Plug/open-ended; 4-pole; Cod. A; H05VV-F 4G 1.5 mm <sup>2</sup> ; 1 m; 1,50 mm <sup>2</sup> ; white	<a href="http://www.wago.com/771-9994/206-102">www.wago.com/771-9994/206-102</a>
	<b>Item no.771-9994/006-102</b> pre-assembled interconnecting cable; Eca; Socket/plug; 4-pole; Cod. A; H05VV-F 4G 1.5 mm <sup>2</sup> ; 1 m; 1,50 mm <sup>2</sup> ; white	<a href="http://www.wago.com/771-9994/006-102">www.wago.com/771-9994/006-102</a>

Subject to changes. Please also observe the further product documentation!

## Required accessories

### Cover

Cover



**Item no.: 770-201**

Lockout cap; 12-pole, separable; for sockets; Plastic; black

[www.wago.com/770-201](http://www.wago.com/770-201)



**Item no.: 770-221**

Lockout cap; 12-pole, separable; for sockets; Plastic; white

[www.wago.com/770-221](http://www.wago.com/770-221)

### Locking levers

Locking system



**Item no.: 770-121**

Locking lever; for flying leads; for manual operation; white

[www.wago.com/770-121](http://www.wago.com/770-121)



**Item no.: 770-131**

Locking lever; for flying leads; for tool operation; white

[www.wago.com/770-131](http://www.wago.com/770-131)



**Item no.: 770-101**

Locking lever; for flying leads; for manual operation; black

[www.wago.com/770-101](http://www.wago.com/770-101)



**Item no.: 770-111**

Locking lever; for flying leads; for tool operation; black

[www.wago.com/770-111](http://www.wago.com/770-111)

## Optional accessories

### Tool

Operating tool



**Item no.: 210-719**

Operating tool; Blade: 2.5 x 0.4 mm; with a partially insulated shaft

[www.wago.com/210-719](http://www.wago.com/210-719)

### Marking accessories

Marker



**Item no.: 770-450/000-002**

Marker card; Plastic; yellow

[www.wago.com/770-450/000-002](http://www.wago.com/770-450/000-002)

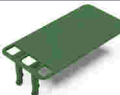

**Item no.: 770-450/000-001**

Marker card; Plastic; green

[www.wago.com/770-450/000-001](http://www.wago.com/770-450/000-001)

Subject to changes. Please also observe the further product documentation!

WAGO GmbH & Co. KG

Hansastr. 27

32423 Minden

Phone: +49571 887-0 | Fax: +49571 887-169

Email: [info.de@wago.com](mailto:info.de@wago.com) | Web: [www.wago.com](http://www.wago.com)

Do you have any questions about our products?

We are always happy to take your call at +49 (571) 887-44222.





Item no.: 770-450/000-005  
Marker card; Plastic; red

[www.wago.com/770-450/000-005](http://www.wago.com/770-450/000-005)



Item no.: 770-450  
Marker card; Plastic; white

[www.wago.com/770-450](http://www.wago.com/770-450)



Item no.: 770-450/000-006  
Marker card; Plastic; blue

[www.wago.com/770-450/000-006](http://www.wago.com/770-450/000-006)



Item no.: 770-450/000-012  
Marker card; Plastic; orange

[www.wago.com/770-450/000-012](http://www.wago.com/770-450/000-012)

#### Cover

Cover



Item no.: 897-2005  
Protective cap; Type4; for sockets and plugs; PVC; red

[www.wago.com/897-2005](http://www.wago.com/897-2005)

#### Downloads

##### Documentation

##### Bid Text

770-124 X81 - Datei	2019 Feb 19	xml 3.1 kB	Download
770-124 doc - Datei	2015 Jun 8	doc 24.1 kB	Download
ausschreiben.de 770-124		URL	Download

##### CAD/CAE-Data

##### CAD data

2D/3D Models 770-124		URL	Download
----------------------	--	-----	----------

##### CAE data

EPLAN Data Portal 770-124		URL	Download
---------------------------	--	-----	----------

WSCAD Universe 770-124		URL	Download
------------------------	--	-----	----------

Subject to changes. Please also observe the further product documentation!

WAGO GmbH & Co. KG  
Hansastr. 27  
32423 Minden  
Phone: +49571 887-0 | Fax: +49571 887-169  
Email: [info.de@wago.com](mailto:info.de@wago.com) | Web: [www.wago.com](http://www.wago.com)

Do you have any questions about our products?  
We are always happy to take your call at +49 (571) 887-44222.

ZUKEN Portal 770-124

[URL](#)

[Download](#)

### Asset Administration Shell

Asset Administration Shell 770-124

[URL](#)

[Download](#)

## Environmental Product Compliance

### Compliance Search

Environmental Product Compliance 770-124

[URL](#)

[Download](#)

Socket; with strain relief housing; 4-pole; Cod. A; 4,00 mm<sup>2</sup>; white

## Installation Notes

### Conductor termination

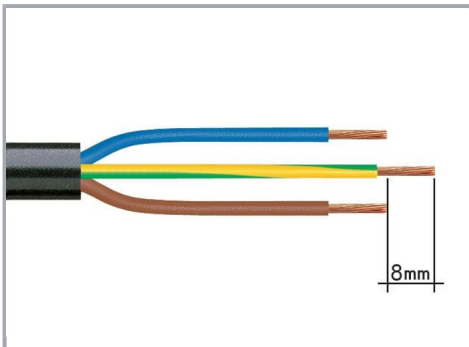

1. Strip length, outer insulation = 35 mm (2-pole), 55 mm (3- to 5-pole)
2. Strip length = 9 mm
3. Extended ground conductor = 8 mm

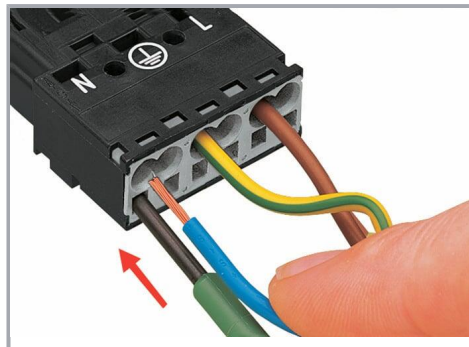

To terminate fine-stranded conductors, open the clamping unit via screwdriver (2.5 mm blade width) and insert a stripped conductor until it hits the backstop.

Subject to changes. Please also observe the further product documentation!

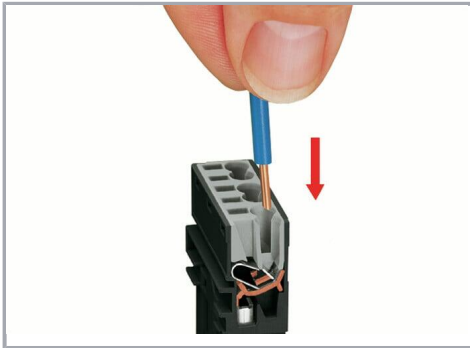

Insert the stripped solid conductor until it hits the backstop.

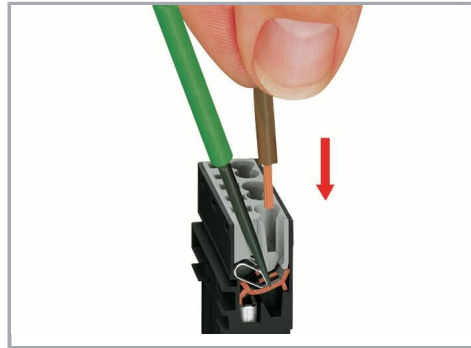

To terminate fine-stranded conductors, open the clamping unit via screwdriver (2.5 mm blade width) and insert a stripped conductor until it hits the backstop.

#### Conductor removal

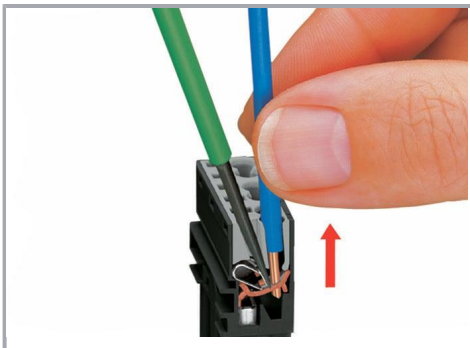

To remove the conductor, actuate the clamp via screwdriver (2.5 mm blade width) and pull out the conductor.

#### Installation

Subject to changes. Please also observe the further product documentation!

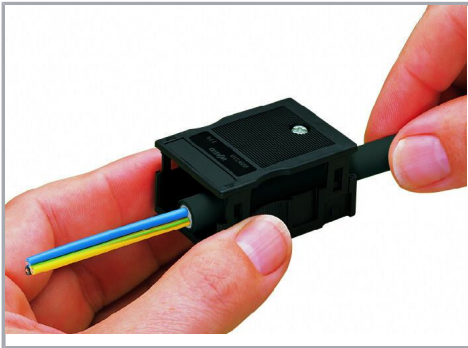

We recommend pulling the pre-latched strain relief housing over the cable prior to termination. However, the strain relief can be mounted at a later time as well.

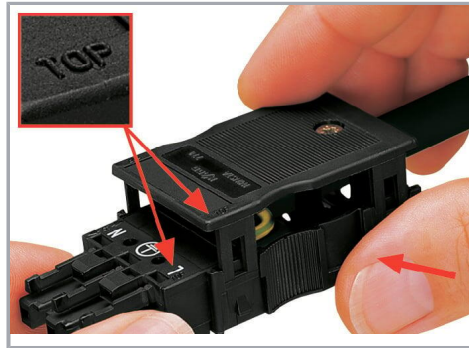

Latch the strain relief housing onto the plug /socket. Note the "TOP" inscription.

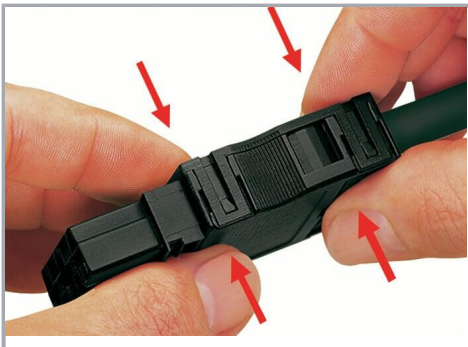

Prepare strain relief housing by snapping together upper and bottom part.



Tighten strain relief screw with screwdriver (2.5 mm blade width).

## Product family

**WINSTA® MIDI**

[Show all products from the family](#)

Subject to changes. Please also observe the further product documentation!