



## WGF70R360G

## Features

- Super Junction technology
- Much lower Ron\*A Performance for On-state efficiency
- Better efficiency due to very low FOM
- Ultra-fast body diode
- VDSS=700V, ID=13A
- $R_{DS(on)} : 0.33\text{m}\Omega$  (Typ) @VG=10V

TO-220F

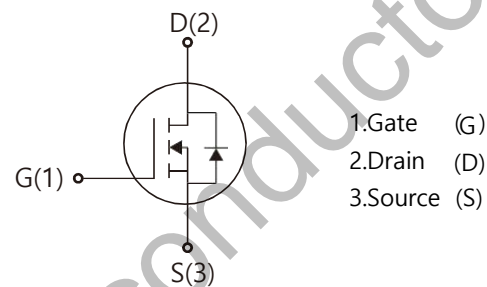
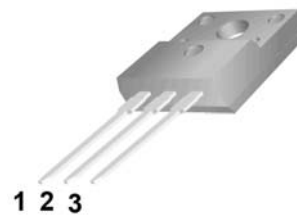

## Absolute Maximum Ratings

Parameter	Symbol	Value	Unit
Drain-source voltage	$V_{DS}$	700	V
Continuous drain current $T_C = 25^\circ\text{C}$ $T_C = 100^\circ\text{C}$	$I_D$	13 8.0	A
Pulsed drain current ( $T_C = 25^\circ\text{C}$ , $t_p$ limited by $T_{jmax}$ )	$I_{D\ pulse}$	52	A
Avalanche energy, single pulse ( $L=30\text{mH}$ , $R_g=50\Omega$ )	$E_{AS}$	90	mJ
Gate-Source voltage	$V_{GS}$	$\pm 30$	V
Power dissipation ( $T_C = 25^\circ\text{C}$ )	$P_{tot}$	128	W
Operating junction and storage temperature	$T_j, T_{stg}$	-55...+150	$^\circ\text{C}$

**Thermal Resistance**

Parameter	Symbol	Value	Unit
Thermal resistance, junction – case. Max	$R_{thJC}$	0.98	°C/W
Thermal resistance, junction – ambient. Max	$R_{thJA}$	93	

**Electrical Characteristic (at  $T_j = 25\text{ }^\circ\text{C}$ , unless otherwise specified)**

Parameter	Symbol	Value			Unit	Test Condition
		min.	typ.	max.		

**Static Characteristic**

Drain-source breakdown voltage	$BV_{DSS}$	700	-	-	V	$V_{GS}=0V, I_D=250\mu A$
Gate threshold voltage	$V_{GS(th)}$	3	-	4	V	$V_{DS}=V_{GS}, I_D=250\mu A$
Zero gate voltage drain current	$I_{DSS}$	-	-	1	$\mu A$	$V_{DS}=700V, V_{GS}=0V$ $T_C=25^\circ C$ $T_C=150^\circ C$
Gate-source leakage current	$I_{GSS}$	-	0.3	100	nA	$V_{GS}=\pm 30V, V_{DS}=0V$
Drain-source on-state resistance	$R_{DS(on)}$	-	0.33	0.38	$\Omega$	$V_{GS}=10V, I_D=3A,$ $T_C=25^\circ C$ $T_C=150^\circ C$
Transconductance	$g_{fs}$	-	10	-	S	$V_{DS}=20V, I_D=6A$

**Dynamic Characteristic**

Input Capacitance	$C_{iss}$	-	742	-	pF	$V_{GS}=0V, V_{DS}=100V,$ $f=1MHz$
Output Capacitance	$C_{oss}$	-	35	-		
Reverse Transfer Capacitance	$C_{rss}$	-	0.5	-		
Gate Total Charge	$Q_G$	-	26	-	nC	$V_{GS}=10V, V_{DS}=480V,$ $I_D=6A, f=1MHz$
Gate-Source charge	$Q_{gs}$	-	3.7	-		
Gate-Drain charge	$Q_{gd}$	-	13.8	-		
Turn-on delay time	$t_{d(on)}$	-	20	-	ns	$T_j=25^\circ C, V_{GS}=10V,$ $I_D=6A, V_{DS}=400V,$ $R_g=27\Omega$
Rise time	$t_r$	-	26	-		
Turn-off delay time	$t_{d(off)}$	-	105	-		
Fall time	$t_f$	-	32	-		
Gate resistance	$R_G$	-	9.3	-	$\Omega$	$V_{GS}=0V, V_{DS}=0V,$ $f=1MHz$

**Body Diode Characteristic**

Parameter	Symbol	Value			Unit	Test Condition
		min.	typ.	max.		
Body Diode Forward Voltage	$V_{SD}$	0.5	0.83	1	V	$V_{GS}=0V, I_{SD}=6A$
Body Diode Reverse Recovery Time	$t_{rr}$	-	210	-	ns	$I_{sd}=6A$ $dI/dt=100A/\mu s, V_{ds}=100V$
Body Diode Reverse Recovery Charge	$Q_{rr}$	-	2.05	-	$\mu C$	

Typical Performance Characteristics

Fig 1. Output Characteristics (Tj=25°C)

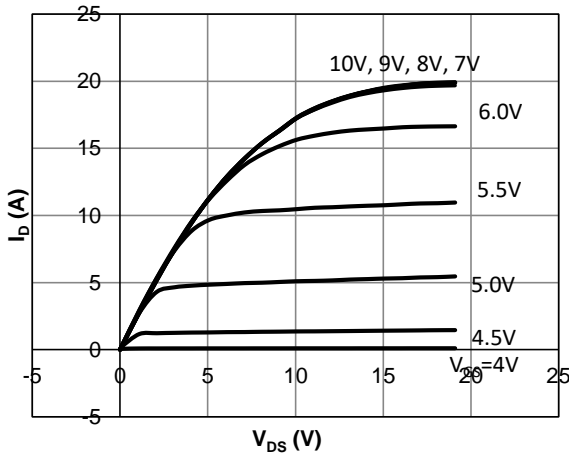

Fig 2. Output Characteristics (Tj=150°C)

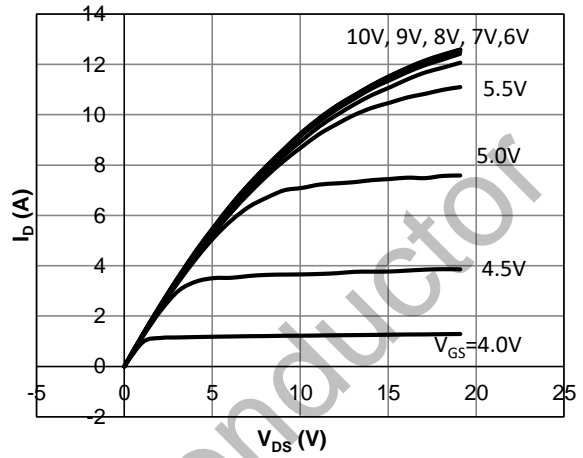

Fig 3: Transfer Characteristics

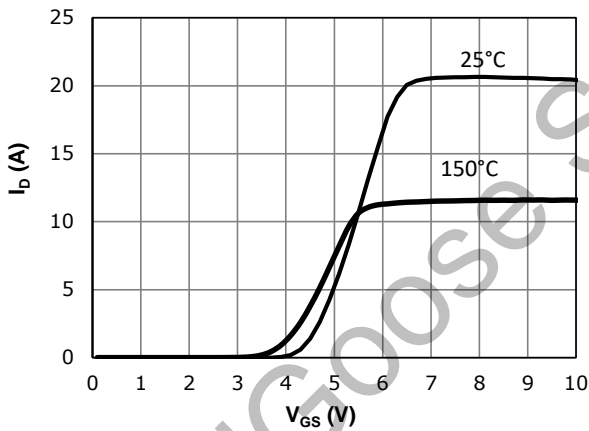

Fig 4: Vth Vs Tj Temperature Characteristics

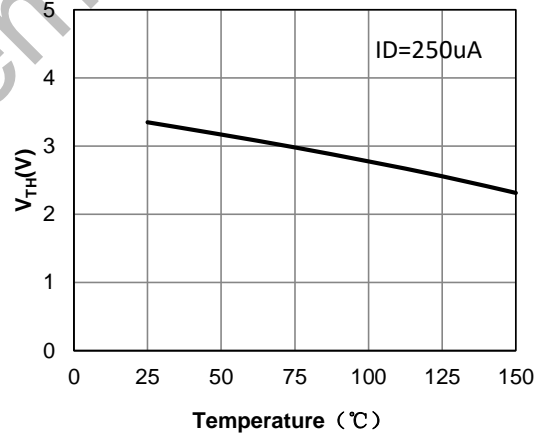

Fig 5: Rds(on) Vs Ids Characteristics (Tc=25°C)

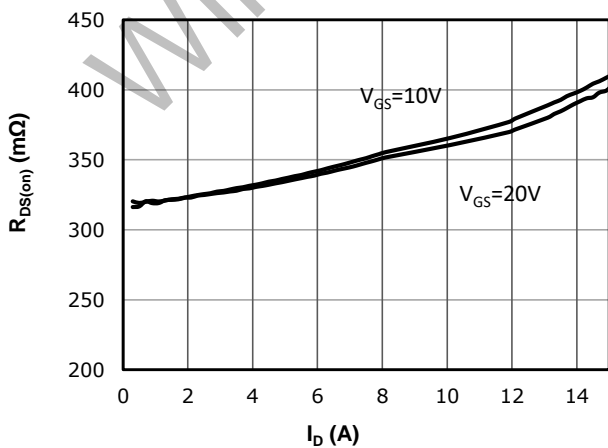

Fig 6: Rds(on) vs. Temperature

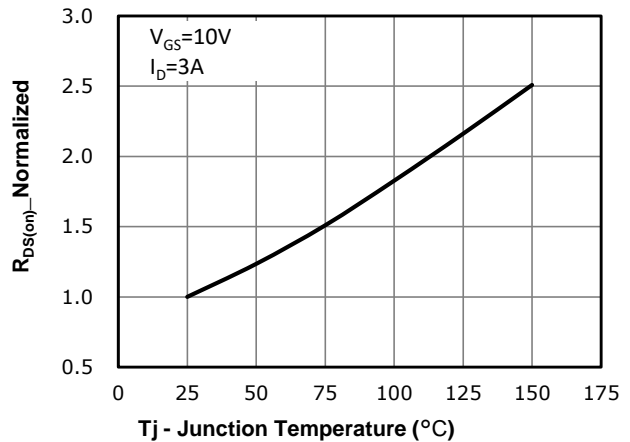

Fig 7: BVDSS vs. Temperature

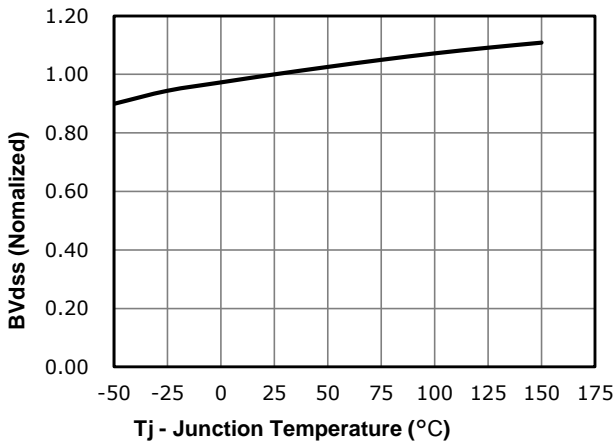

Fig 8: Rds(on) vs Gate Voltage

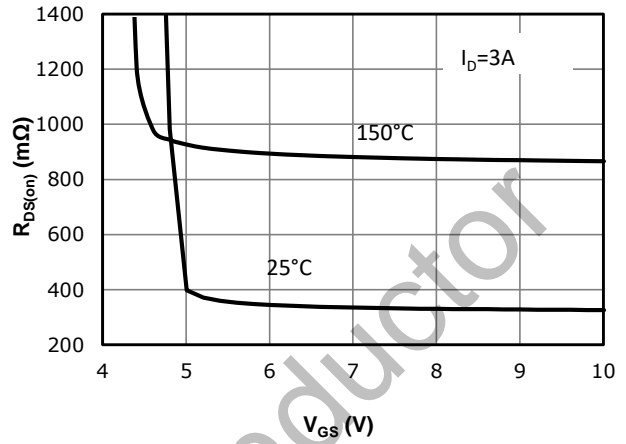

Fig 9: Body-diode Forward Characteristics

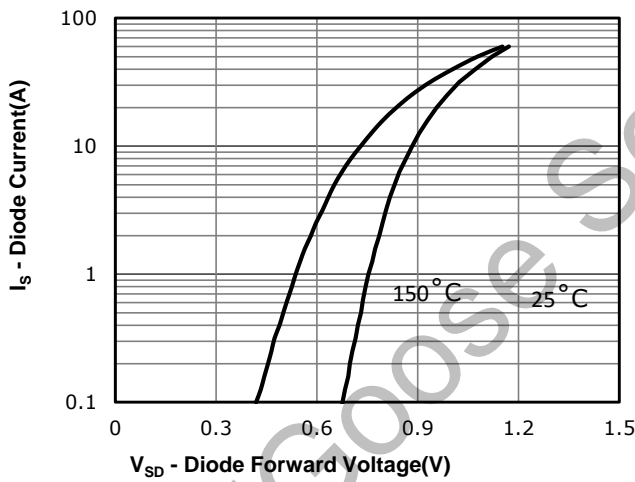

Fig 10: Gate Charge Characteristics

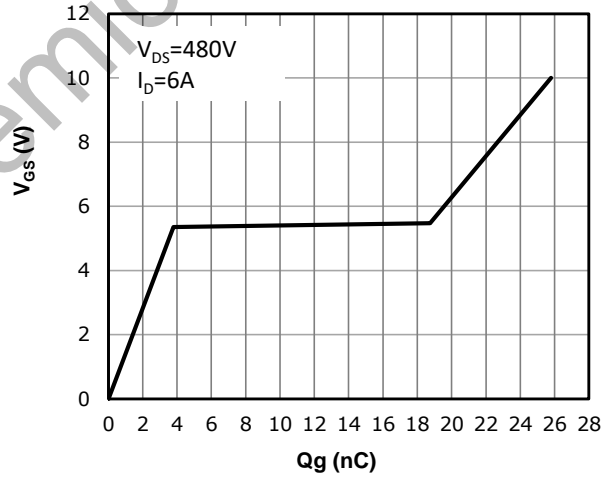

Fig 11: Capacitance Characteristics

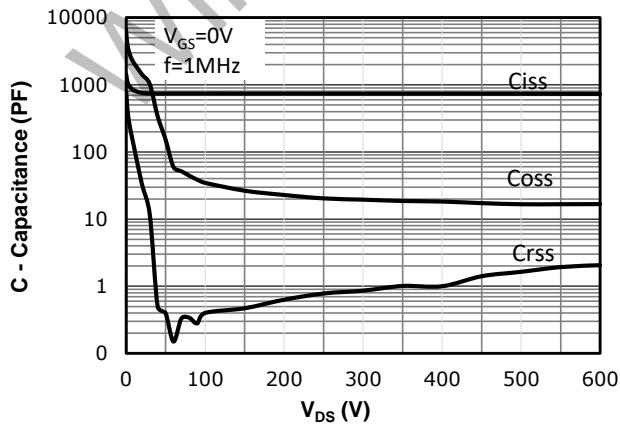

Fig 12: Safe Operating Area

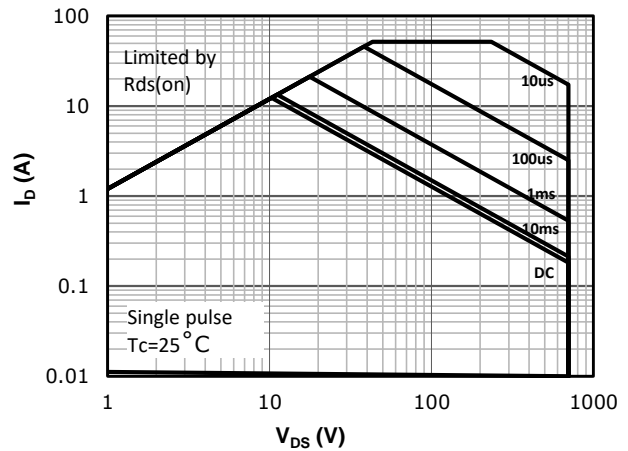
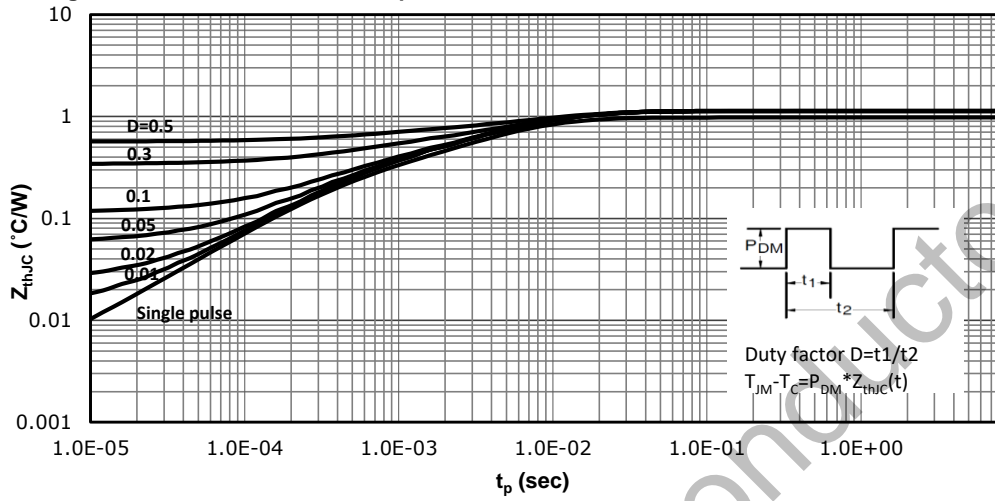

Fig 13: Max. Transient Thermal Impedance



WildGoose Semiconductor

**Test Circuit & Waveform**

Gate Charge Test Circuit & Waveform

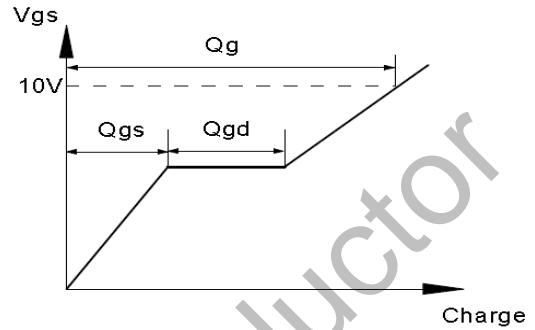
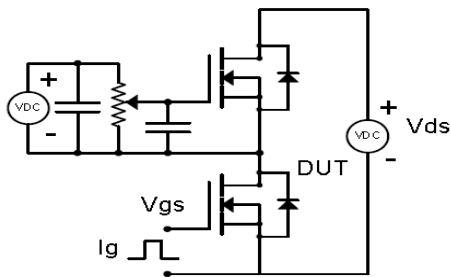

Resistive Switching Test Circuit & Waveforms

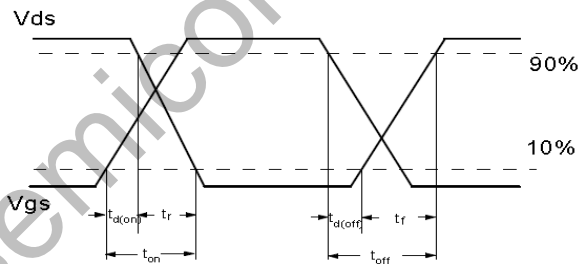
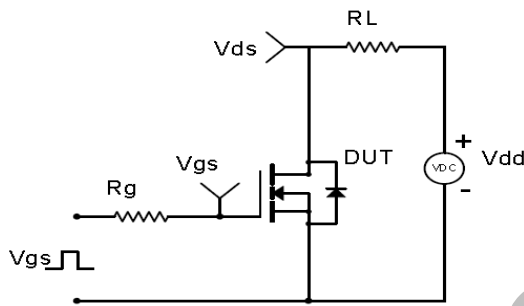

Unclamped Inductive Switching (UIS) Test Circuit & Waveforms

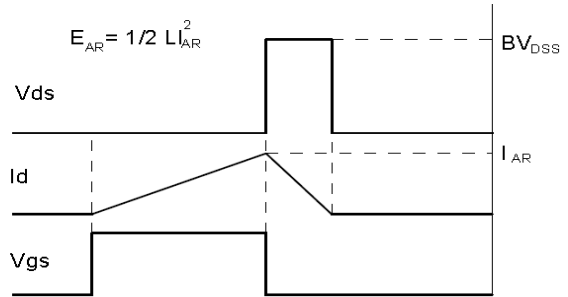
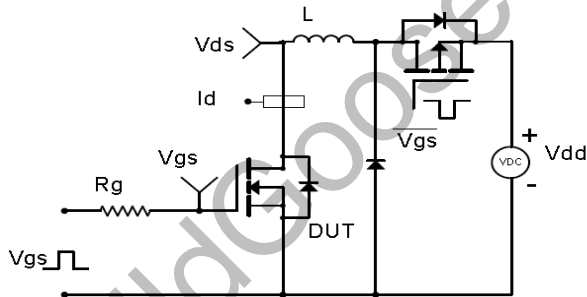

Diode Recovery Test Circuit & Waveforms

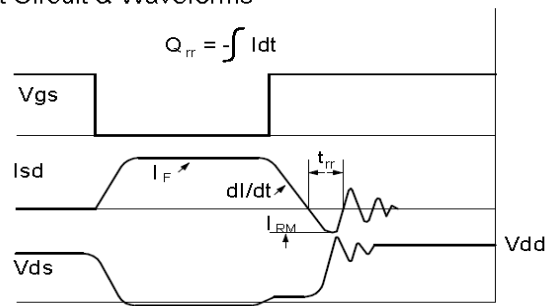
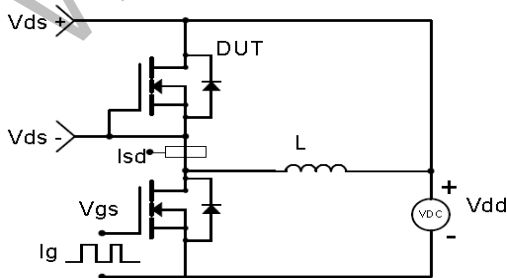

**Package Dimension**

TO-220F

