

LN2306ELT1G

N-Channel 30V(D-S) MOSFET

1. FEATURES

- VDS= 30V
- RDS(ON) ≤ 65mΩ@ VGS =10V
- RDS(ON) ≤ 75mΩ@ VGS =4.5V
- RDS(ON) ≤ 105mΩ@ VGS=2.5V
- RDS(ON) ≤ 400mΩ@ VGS=1.7V
- We declare that the material of product compliance with RoHS requirements and Halogen Free.
- Gate-Source ESD Protected

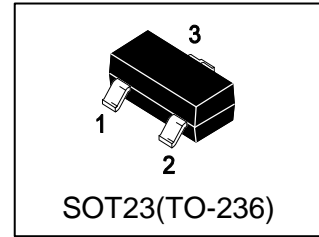

2. APPLICATIONS

- Power Management in Note book
- Portable Equipment
- Battery Powered System
- Load Switch

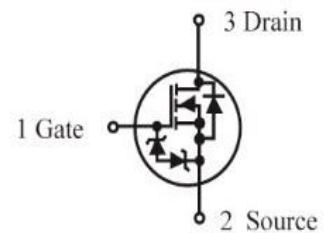

3. DEVICE MARKING AND ORDERING INFORMATION

Device	Marking	Shipping
LN2306ELT1G	2E	3000/Tape&Reel

4. MAXIMUM RATINGS(Ta = 25°C)

Parameter	Symbol	Limits	Unit
Drain-Source Voltage	VDSS	30	V
Gate-to-Source Voltage – Continuous	VGS	± 12	V
Drain Current	ID	3.4	A
Pulsed Drain Current(Note 1)	IDM	12	A

5. THERMAL CHARACTERISTICS

Parameter	Symbol	Limits	Unit
Maximum Power Dissipation	PD	1.4	W
Thermal Resistance, Junction-to-Ambient(Note 2)	RθJA	140	°C/W
Junction and Storage temperature	TJ, Tstg	-55~+150	°C

1. Repetitive Rating: Pulse width limited by the Maximum junction temperature.
2. 1-in² 2oz Cu PCB board.

6. ELECTRICAL CHARACTERISTICS (Ta= 25°C)

Characteristic	Symbol	Min.	Typ.	Max.	Unit	
STATIC						
Drain–Source Breakdown Voltage (VGS = 0, ID = 250μA)	V(BR)DSS	30	-	-	V	
Zero Gate Voltage Drain Current (VDS=30V, VGS=0V)	IDSS	-	-	1	μA	
Gate–Body Leakage Current, Forward (VDS = 0 V, VGS = 10 V)	IGSSF	-	-	10	μA	
Gate–Body Leakage Current, Reverse (VDS = 0 V, VGS = -10 V)	IGSSR	-	-	-10	μA	
Gate Threshold Voltage (VDS = VGS, ID = 250μA)	VGS(th)	0.6	-	1.4	V	
Static Drain–Source On–State Resistance (VGS = 10 V, ID = 3.4 A) (VGS = 4.5 V, ID = 2.7 A) (VGS = 2.5 V, ID = 1 A) (VGS = 1.7 V, ID = 0.5 A)	RDS(on)	-	48 54 75 180	65 75 105 400	mΩ	
DYNAMIC						
Input Capacitance (VGS = 0 V, f = 1.0MHz, VDS= 15 V)	Ciss	-	247	-	pF	
Output Capacitance (VGS = 0 V, f = 1.0MHz, VDS= 15 V)	Coss	-	33	-	pF	
Reverse Transfer Capacitance (VGS = 0 V, f = 1.0MHz, VDS= 15 V)	Crss	-	5	-	pF	
Total Gate Charge	(VGS = 4.5 V, ID=2.1A, VDS= 15 V)	Qg	-	4.7	-	nC
Gate–Source Charge		Qgs	-	1.9	-	
Gate–Drain Charge		Qgd	-	1.6	-	
Turn-On Delay Time	(VDD = 15V, RL = 15Ω ID = 1A, VGEN = 10V, RG = 6Ω)	td(on)	-	97.2	-	ns
Rise Time		tr	-	128	-	
Turn-Off Delay Time		td(off)	-	2600	-	
Fall Time		tf	-	677	-	
Forward Voltage (VGS = 0 V, ISD = 3.4 A)	VSD	-	-	1.2	V	

3.Pulse Test: Pulse Width ≤300 μs, Duty Cycle ≤2.0%.

7. ELECTRICAL CHARACTERISTICS CURVES

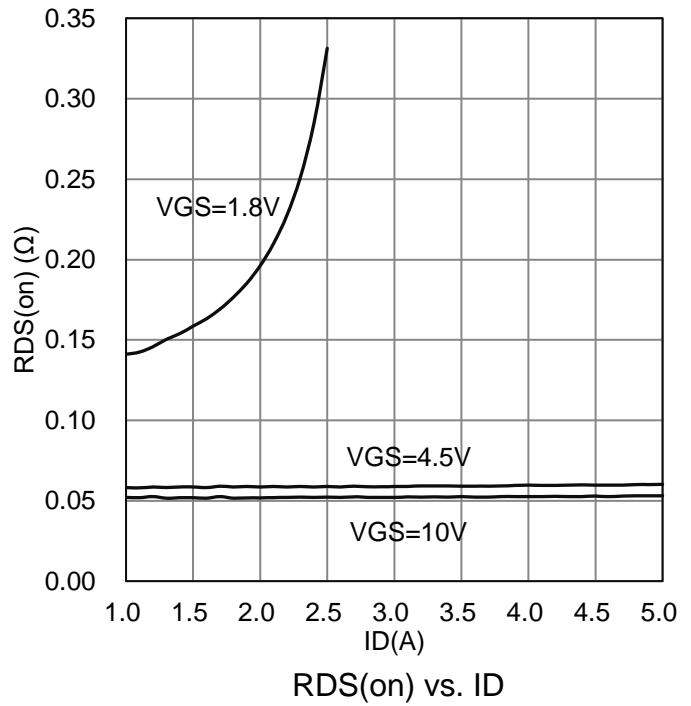
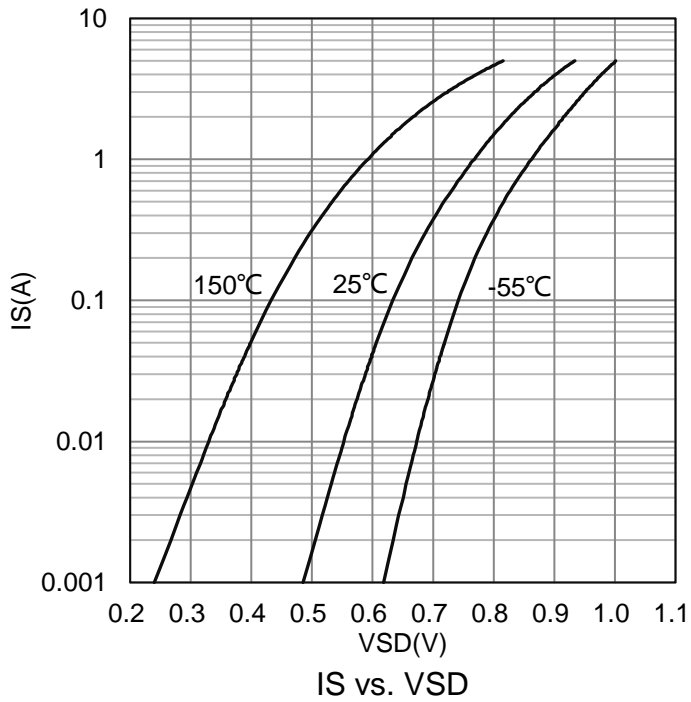
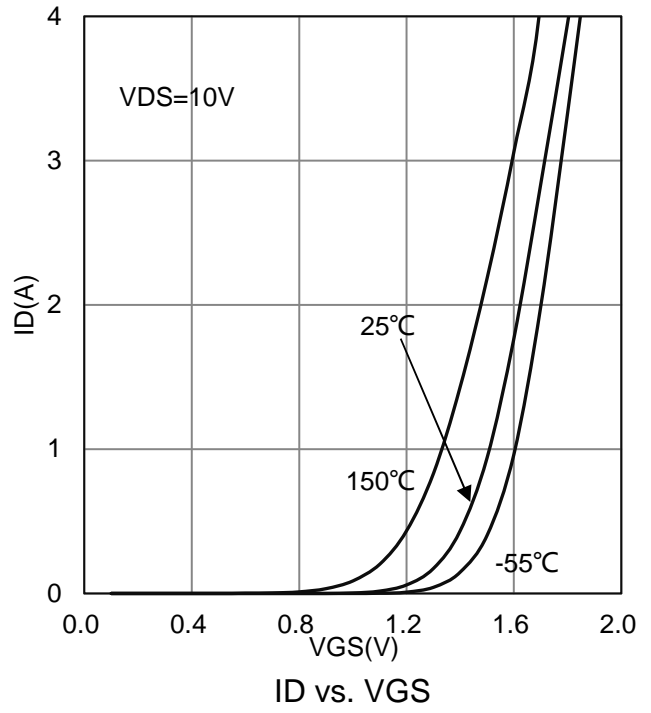
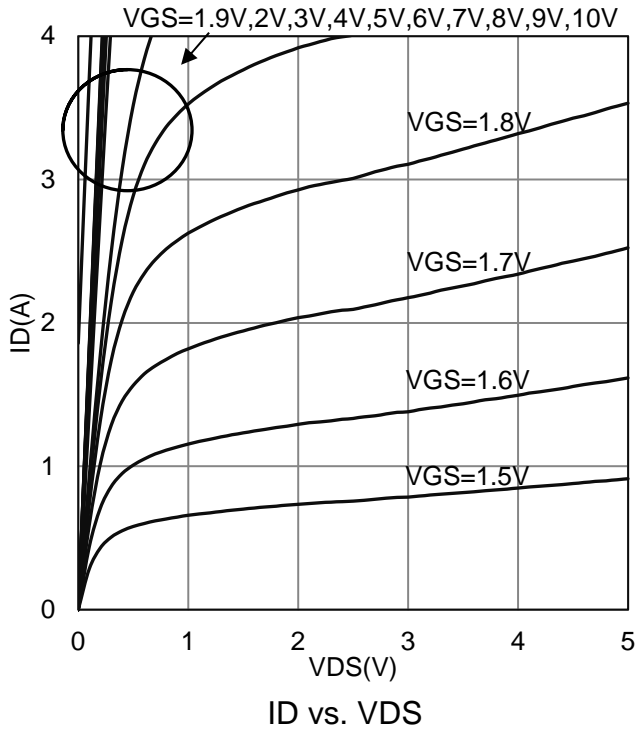

7. ELECTRICAL CHARACTERISTICS CURVES(Con.)

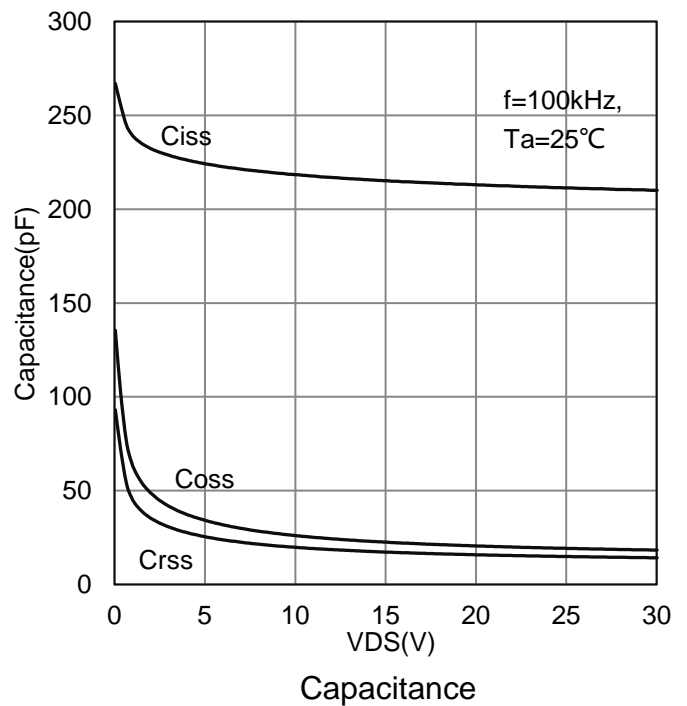
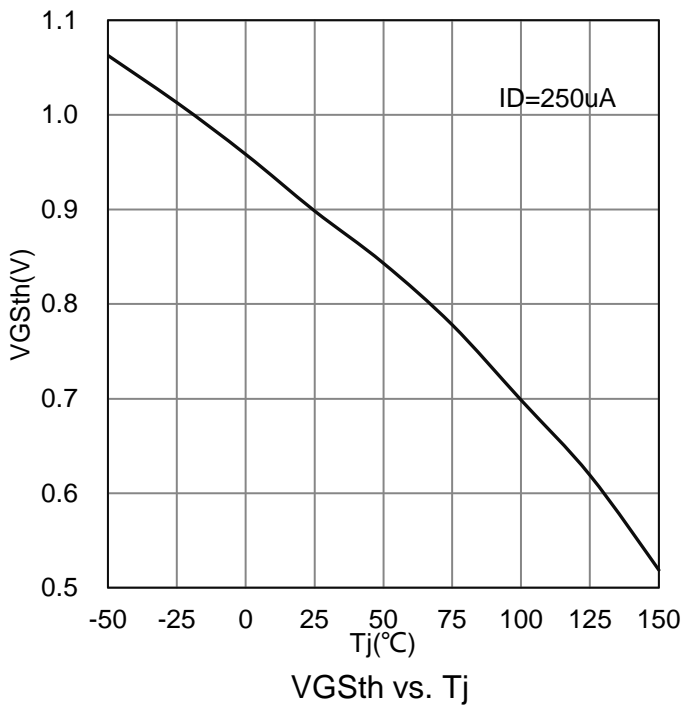
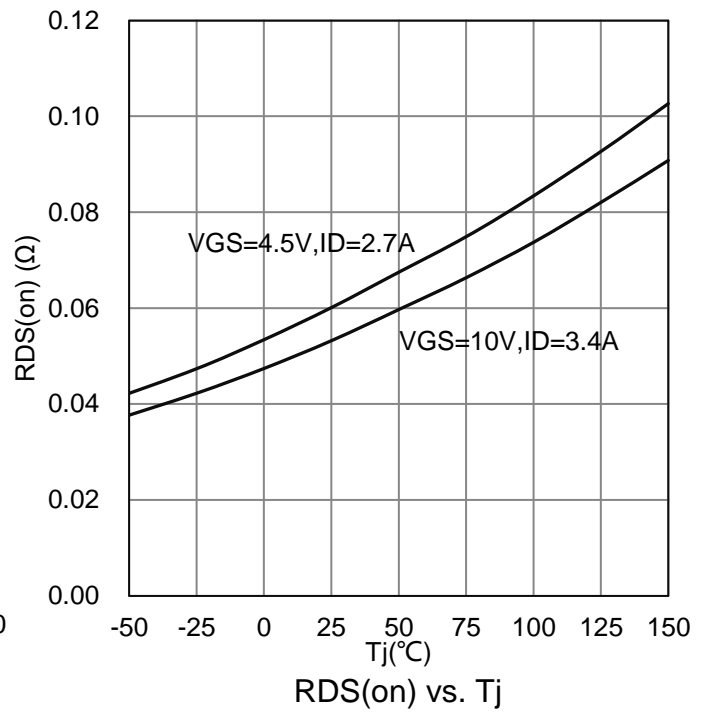
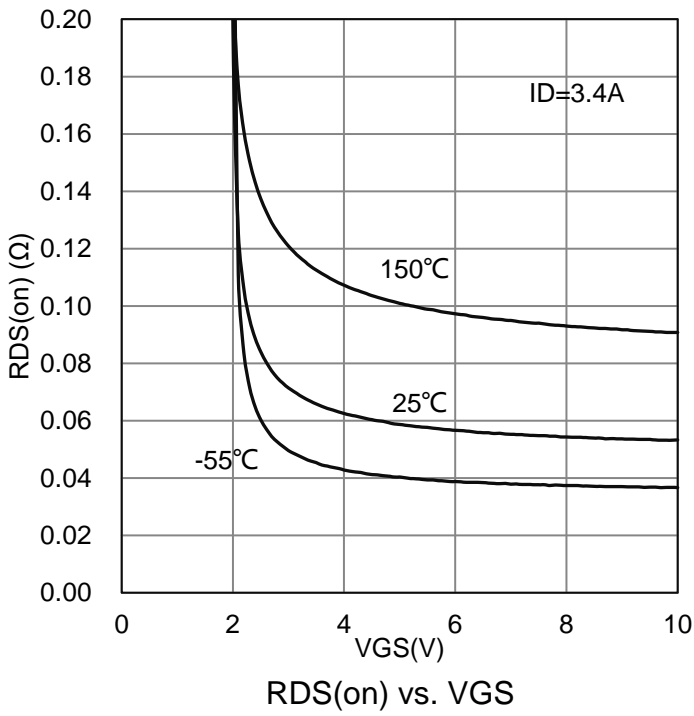

7. ELECTRICAL CHARACTERISTICS CURVES(Con.)

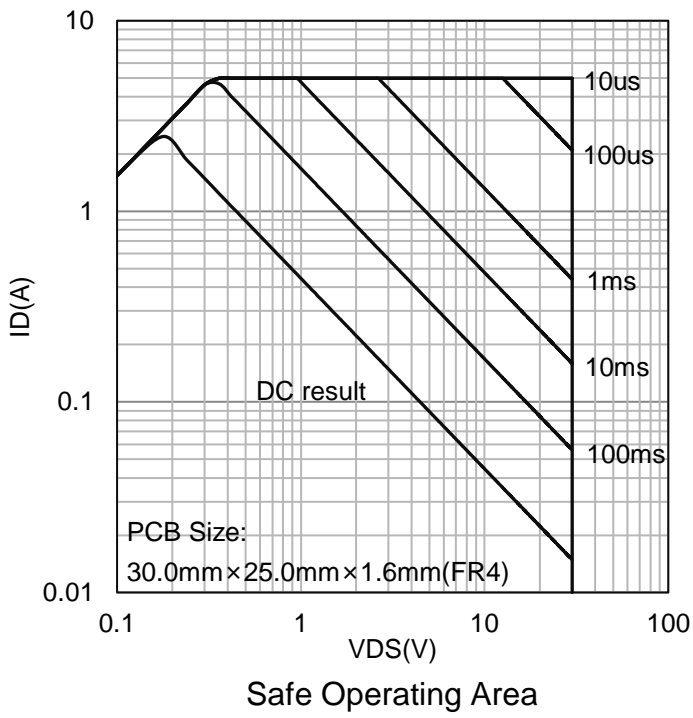

8.OUTLINE AND DIMENSIONS

Notes:

1. DIMENSIONING AND TOLERANCING PER ANSI Y14.5M, 1982.
2. CONTROLLING DIMENSION: MILLIMETERS.
3. MAXIMUM LEAD THICKNESS INCLUDES LEAD FINISH. MINIMUM LEAD THICKNESS IS THE MINIMUM THICKNESS OF BASE MATERIAL.
4. DIMENSIONS D AND E DO NOT INCLUDE MOLD FLASH, PROTRUSIONS OR GATE BURRS.

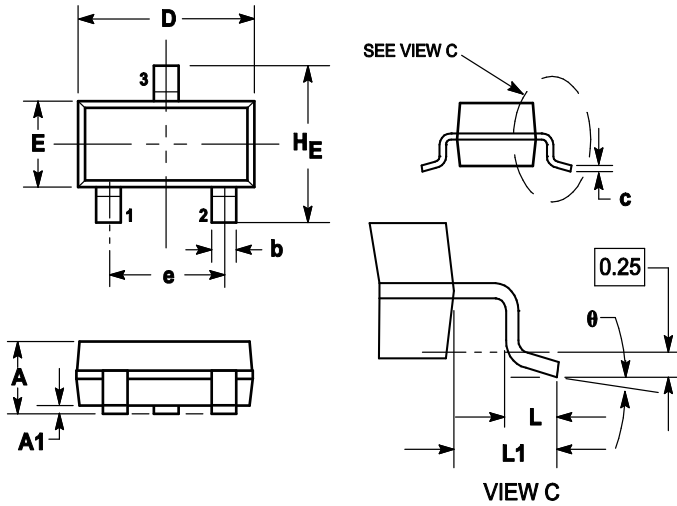

DIM	MILLIMETERS			INCHES		
	MIN	NOM	MAX	MIN	NOM	MAX
A	0.89	1	1.11	0.035	0.04	0.044
A1	0.01	0.06	0.1	0.001	0.002	0.004
b	0.37	0.44	0.5	0.015	0.018	0.02
c	0.09	0.13	0.18	0.003	0.005	0.007
D	2.80	2.9	3.04	0.11	0.114	0.12
E	1.20	1.3	1.4	0.047	0.051	0.055
e	1.78	1.9	2.04	0.07	0.075	0.081
L	0.10	0.2	0.3	0.004	0.008	0.012
L1	0.35	0.54	0.69	0.014	0.021	0.029
HE	2.10	2.4	2.64	0.083	0.094	0.104
θ	0°	---	10°	0°	---	10°

9.SOLDERING FOOTPRINT

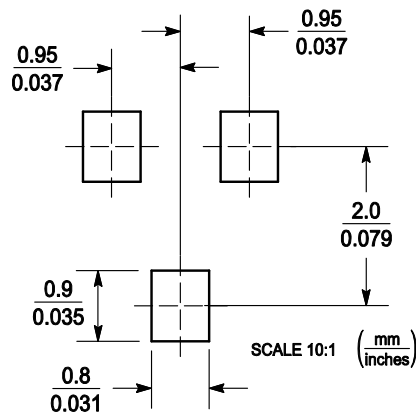

DISCLAIMER

- Curve guarantee in the specification. The curve of test items with electric parameter is used as quality guarantee. The curve of test items without electric parameter is used as reference only.
- Before you use our Products for new Project, you are requested to carefully read this document and fully understand its contents. LRC shall not be in any way responsible or liable for failure, malfunction or accident arising from the use of any LRC's Products against warning, caution or note contained in this document.
- All information contained in this document is current as of the issuing date and subject to change without any prior notice. Before purchasing or using LRC's Products, please confirm the latest information with a LRC sales representative.