

3-643816-8 ✓ ACTIVE



MTA 100

TE Internal #: 3-643816-8

Standard Rectangular Connectors, Connector Assembly,  
Receptacle, Mating Alignment, Polarization Mating Alignment  
Type, Mating Retention, MTA 100

[View on TE.com >](#)

Connectors > Rectangular Connectors > Standard Rectangular Connectors > Nylon Tin Plated Receptacle: 2.54 mm, with Mating Alignment, MTA 100

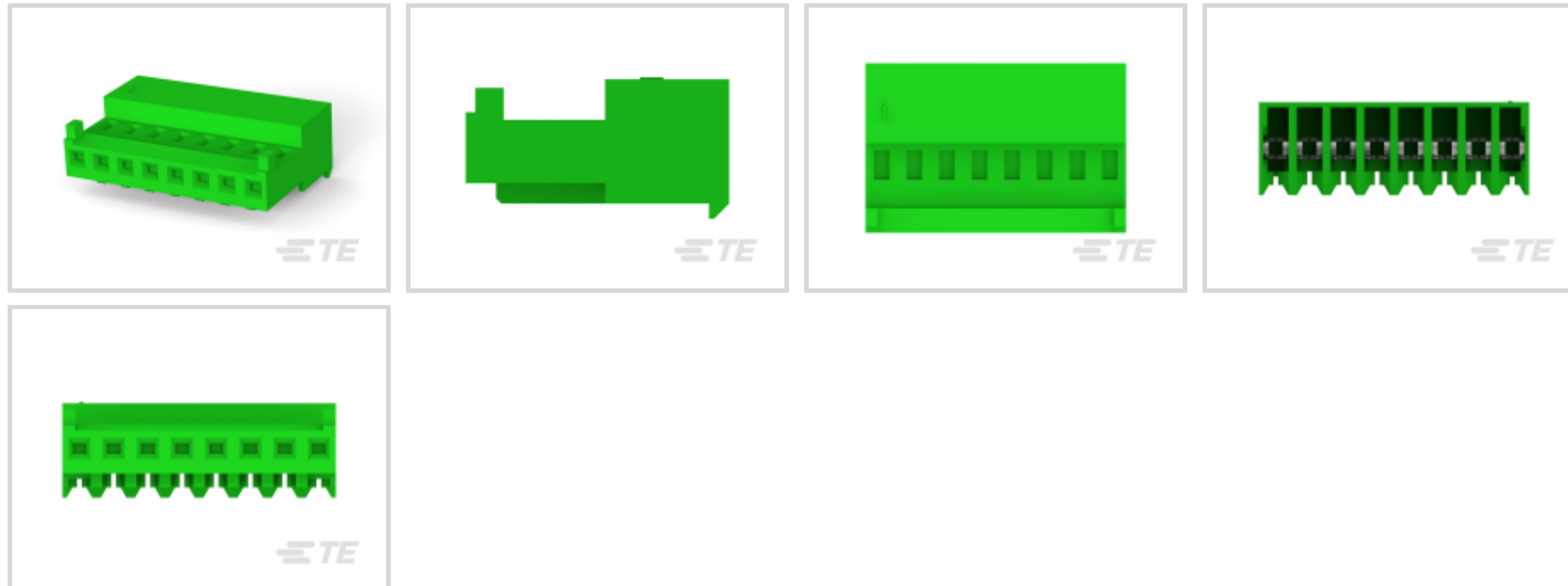

Connector Product Type: **Connector Assembly**

Connector & Housing Type: **Receptacle**

Mating Alignment: **With**

Mating Alignment Type: **Polarization**

Mating Retention: **With**

[All Nylon Tin Plated Receptacle: 2.54 mm, with Mating Alignment, MTA 100 \(127\)](#)

## Features

### Product Type Features

Compatible With Discrete Wire Type	Stranded
Connector Product Type	Connector Assembly
Connector & Housing Type	Receptacle
Connector System	Wire-to-Board
Sealable	No
Connector & Contact Terminates To	Wire & Cable

### Configuration Features

Number of Cavities	8
Contacts Preloaded	Yes
Number of Positions	8
Number of Rows	1

### Electrical Characteristics



Operating Voltage	250 VAC
-------------------	---------

### Contact Features

Contact Type	Receptacle
--------------	------------

Wire Contact Termination Area Plating Material	Tin
--	-----

Contact Underplating Material	Nickel
-------------------------------	--------

Contact Mating Area Plating Material	Tin
--------------------------------------	-----

Contact Retention Within Housing	With
----------------------------------	------

Contact Current Rating (Max)	5 A
------------------------------	-----

### Termination Features

Termination Method to Wire & Cable	Insulation Displacement (IDC)
------------------------------------	-------------------------------

### Mechanical Attachment

Contact Retention Type Within Housing	Locking Lance
---------------------------------------	---------------

Mating Alignment	With
------------------	------

Mating Alignment Type	Polarization
-----------------------	--------------

Mating Retention	With
------------------	------

Mating Retention Type	Locking Ramp
-----------------------	--------------

Connector Mounting Type	Cable Mount (Free-Hanging)
-------------------------	----------------------------

### Housing Features

Housing Material	Nylon
------------------	-------

Housing Color	Green
---------------	-------

Centerline (Pitch)	2.54 mm[.1 in]
--------------------	----------------

### Dimensions

Connector Height	13.21 mm[.52 in]
------------------	------------------

Product Width	6.99 mm[.275 in]
---------------	------------------

Product Length	20.32 mm[.8 in]
----------------	-----------------

Wire Size	.08 – .09 mm <sup>2</sup>
-----------	---------------------------

### Usage Conditions

Operating Temperature Range	-55 – 105 °C[-67 – 221 °F]
-----------------------------	----------------------------

### Operation/Application

Shielded	No
----------	----

Circuit Application	Signal
---------------------	--------

### Industry Standards



CSA Rating	LR 7189
UL Rating	Recognized
Compatible With Agency/Standards Products	CSA, UL
Compatible With Approved Standards Products	UL E28476
UL Flammability Rating	UL 94V-2

### Packaging Features

Packaging Quantity	500
Packaging Method	Bag/Box

### Product Compliance

[For compliance documentation, visit the product page on TE.com>](#)

EU RoHS Directive 2011/65/EU	Compliant
EU ELV Directive 2000/53/EC	Compliant
China RoHS 2 Directive MIIT Order No 32, 2016	No Restricted Materials Above Threshold
EU REACH Regulation (EC) No. 1907/2006	Current ECHA Candidate List: JUNE 2023 (235) Candidate List Declared Against: JUNE 2023 (235) Does not contain REACH SVHC
Halogen Content	BFR/CFR/PVC Free, but Br/Cl >900 ppm in other sources.
Solder Process Capability	Not applicable for solder process capability

#### Product Compliance Disclaimer

This information is provided based on reasonable inquiry of our suppliers and represents our current actual knowledge based on the information they provided. This information is subject to change. The part numbers that TE has identified as EU RoHS compliant have a maximum concentration of 0.1% by weight in homogenous materials for lead, hexavalent chromium, mercury, PBB, PBDE, DBP, BBP, DEHP, DIBP, and 0.01% for cadmium, or qualify for an exemption to these limits as defined in the Annexes of Directive 2011/65/EU (RoHS2). Finished electrical and electronic equipment products will be CE marked as required by Directive 2011/65/EU. Components may not be CE marked. Additionally, the part numbers that TE has identified as EU ELV compliant have a maximum concentration of 0.1% by weight in homogenous materials for lead, hexavalent chromium, and mercury, and 0.01% for cadmium, or qualify for an exemption to these limits as defined in the Annexes of Directive 2000/53/EC (ELV). Regarding the REACH Regulation, the information TE provides on SVHC in articles for this part number is based on the latest European Chemicals Agency (ECHA) 'Guidance on requirements for substances in articles' posted at this URL: <https://echa.europa.eu/guidance-documents/guidance-on-reach>

### Compatible Parts



TE Part # CAT-104MTA-PLSCC  
Polyester PCB Connector Covers: 2.54 mm, MTA 100



TE Part # 640454-8  
08P MTA100 HDR ASSY SQ STR POL



TE Part # CAT-104MTA-NYLCC  
Nylon PCB Connector Covers: 2.54 mm, MTA 100



TE Part # CAT-104MTA-NTPMP  
MTA Plug: Nylon, Tin Plated, 2.54 mm, with Mating Alignment



TE Part # CAT-104MTA-PVUNH  
PCB Header: Polyester, Vertical, Unshrouded, No Mating Alignment



TE Part # CAT-104MTA-NVSMH  
Nylon Vertical PCB Header: 2.54mm, Surface Mount, MTA 100



TE Part # CAT-104MTA-PRUSH  
PCB Header: Polyester, Right Angle, Unshrouded



TE Part # 640455-8  
08P MTA100 HDR ASSY SQ R/A POL



TE Part # CAT-104MTA-PVSHH  
Polyester Vertical PCB Header: 2.54 mm, Shrouded, MTA 100



TE Part # CAT-104MTA-PVBRH  
Polyester Vertical PCB Header: 2.54 mm, Breakaway, MTA 100



TE Part # 1744382-8  
08P MTA100 HDR ASSY,SM,SN, LF



TE Part # 58579-1  
MTA 100 MANUAL TOOL ASSEMBLY DISCRETE



TE Part # CAT-104MTA-PRSMH  
PCB Header, Right Angle, Polyester, 2.54 mm



TE Part # 3-647050-8  
08P MTA100 HDR ASSY F/L HITEMP



TE Part # 58074-1  
MTA 50/100/156 MANUAL TOOL FRAME



TE Part # 58246-3  
MTA 100 CRIMP HEAD PRODUCTION RBBN CABLE



TE Part # 58039-1  
MTA 100 ARBOR FIXTURE DISCRETE RBN CABLE



TE Part # 58246-2  
MTA 100 CRIMP HEAD PRODUCTION DISCRETE

Also in the Series | **MTA 100**



Connector Caps & Covers(69)

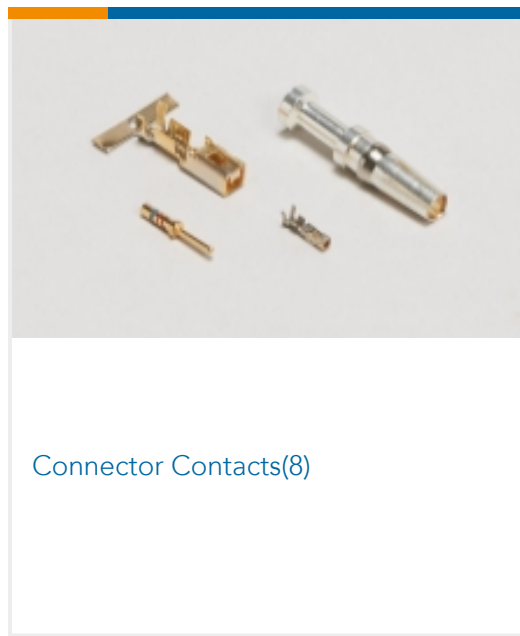

Connector Contacts(8)



Connector Hardware(1)

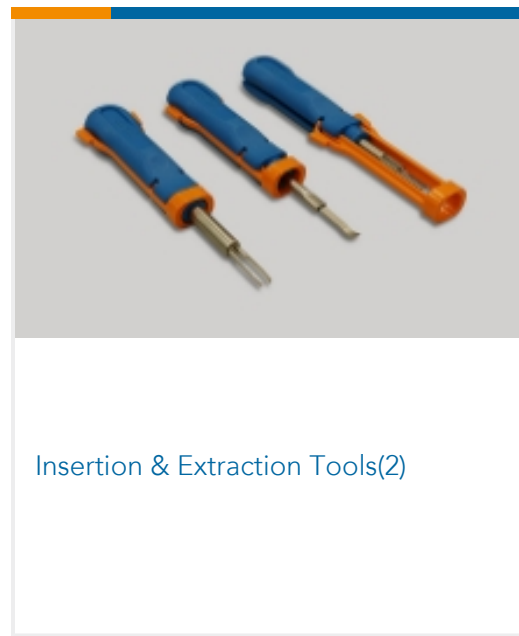

Insertion & Extraction Tools(2)



PCB Headers & Receptacles(440)

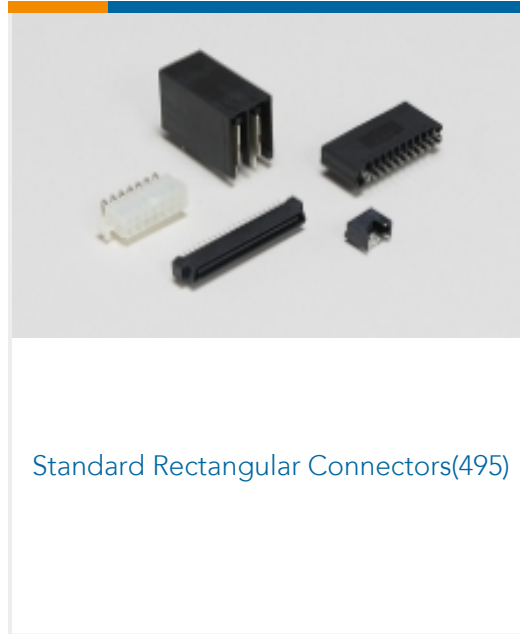

Standard Rectangular Connectors(495)

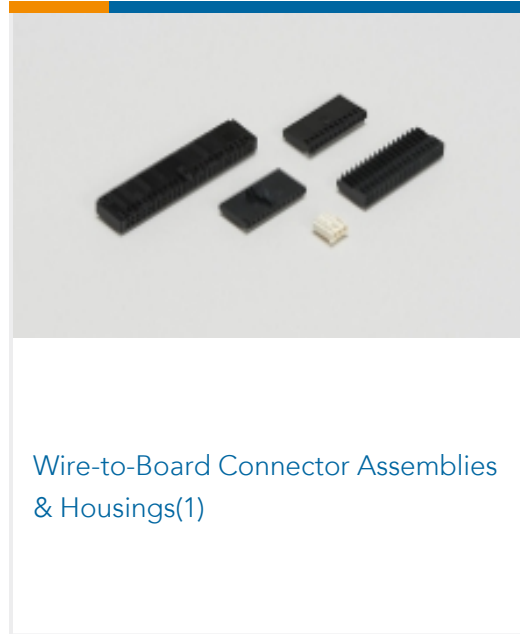

Wire-to-Board Connector Assemblies & Housings(1)

## Customers Also Bought



TE Part #3-643816-3  
Nylon Tin Plated Receptacle: 2.54 mm,  
with Mating Alignment, MTA 100

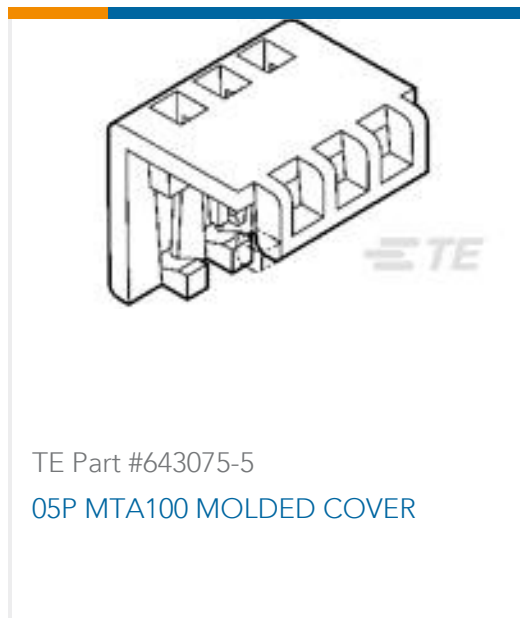

TE Part #643075-5  
05P MTA100 MOLDED COVER



TE Part #170363-1  
MINI UNIVERSAL M-N-L PIN LP



TE Part #2-35109-1  
PIDG 12-10 R 10; TAPE



TE Part #2150356-1  
OCEAN\_2.0\_Applicator-E-120F1800



TE Part #7-2150356-7  
OCEAN\_2.0\_SPARE\_PART\_KIT-  
120F1800



TE Part #L9000025-01  
Antenna 1/4 Wave R-Angle 2.4GHz RPS



TE Part #375021  
FLYWHEEL DOG DRIVING PLATE



TE Part #458949-6  
STOP, WIRE

## Documents



### Product Drawings

#### 08P MTA100 CONN ASSY POL RIB

English

---

### CAD Files

#### Customer View Model

[ENG\\_CVM\\_CVM\\_3-643816-8\\_P.2d\\_dxf.zip](#)

English

#### 3D PDF

3D

#### Customer View Model

[ENG\\_CVM\\_CVM\\_3-643816-8\\_P.3d\\_igs.zip](#)

English

#### Customer View Model

[ENG\\_CVM\\_CVM\\_3-643816-8\\_P.3d\\_stp.zip](#)

English

By downloading the CAD file I accept and agree to the [Terms and Conditions](#) of use.

---

### Product Specifications

#### Application Specification

English

---

### Agency Approvals

#### Agency Approval Document

English