

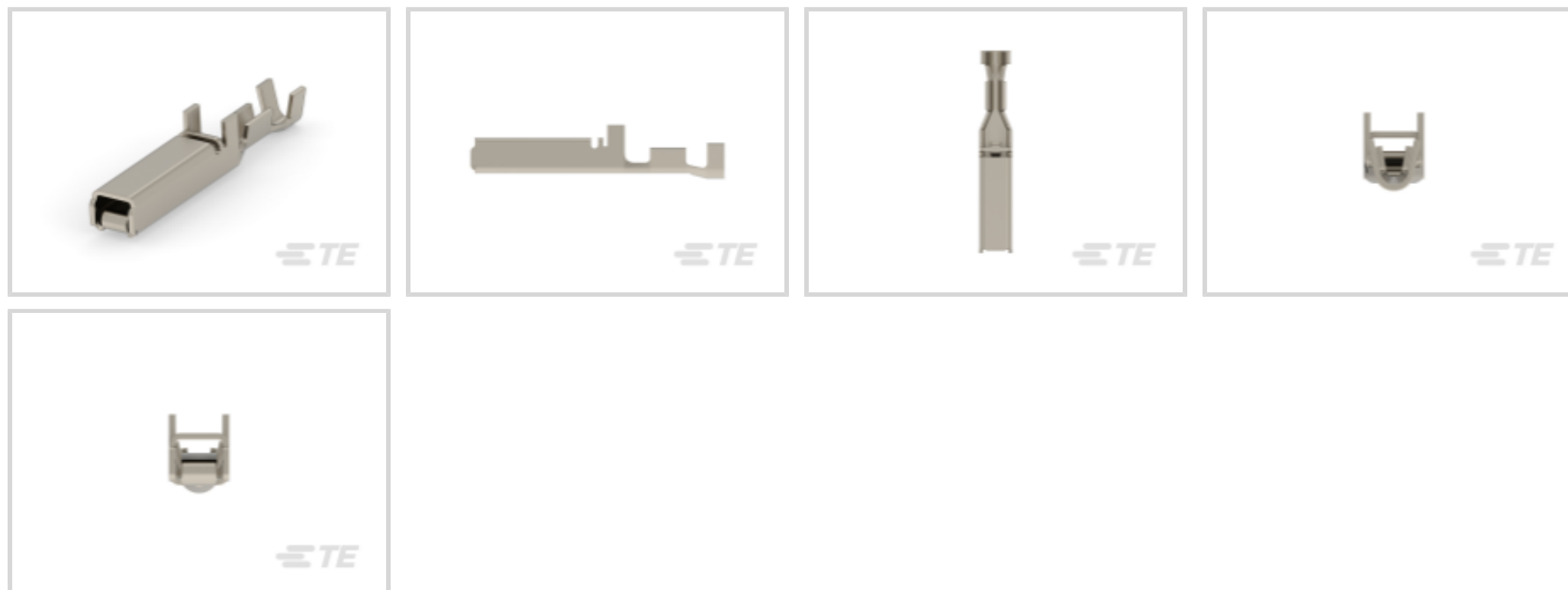

Connectors > Contacts > Connector Contacts > Contact: Component To Wire; 15A, 28-14 wire size



Contact Type: **Receptacle**

Contact Mating Area Plating Material: **Gold**

Wire Size: **1.23 – 2.27 mm²**

Product Terminates To: **Wire & Cable**

[All Contact: Component To Wire; 15A, 28-14 wire size \(91\)](#)

Features

Contact Features

Mating Tab Width	2 mm[.08 in]
Mating Tab Thickness	.64 mm[.025 in]
Contact Type	Receptacle
Contact Mating Area Plating Material	Gold
Contact Current Rating (Max)	15 A

Termination Features

Product Terminates To	Wire & Cable
-----------------------	--------------

Dimensions

Wire Size	1.23 – 2.27 mm ²
-----------	-----------------------------

Usage Conditions

Operating Temperature Range	-55 – 105 °C[-67 – 221 °F]
-----------------------------	----------------------------

Operation/Application

Circuit Application	Power & Signal
---------------------	----------------



Packaging Features

Packaging Method	Bag & Box
------------------	-----------

Product Compliance

[For compliance documentation, visit the product page on TE.com>](#)

EU RoHS Directive 2011/65/EU	Compliant
EU ELV Directive 2000/53/EC	Compliant
China RoHS 2 Directive MIIT Order No 32, 2016	No Restricted Materials Above Threshold
EU REACH Regulation (EC) No. 1907/2006	Current ECHA Candidate List: JUNE 2023 (235) Candidate List Declared Against: JUNE 2023 (235) Does not contain REACH SVHC
Halogen Content	Low Halogen - Br, Cl, F, I < 900 ppm per homogenous material. Also BFR/CFR/PVC Free
Solder Process Capability	Not applicable for solder process capability

Product Compliance Disclaimer

This information is provided based on reasonable inquiry of our suppliers and represents our current actual knowledge based on the information they provided. This information is subject to change. The part numbers that TE has identified as EU RoHS compliant have a maximum concentration of 0.1% by weight in homogenous materials for lead, hexavalent chromium, mercury, PBB, PBDE, DBP, BBP, DEHP, DIBP, and 0.01% for cadmium, or qualify for an exemption to these limits as defined in the Annexes of Directive 2011/65/EU (RoHS2). Finished electrical and electronic equipment products will be CE marked as required by Directive 2011/65/EU. Components may not be CE marked. Additionally, the part numbers that TE has identified as EU ELV compliant have a maximum concentration of 0.1% by weight in homogenous materials for lead, hexavalent chromium, and mercury, and 0.01% for cadmium, or qualify for an exemption to these limits as defined in the Annexes of Directive 2000/53/EC (ELV). Regarding the REACH Regulation, the information TE provides on SVHC in articles for this part number is based on the latest European Chemicals Agency (ECHA) 'Guidance on requirements for substances in articles' posted at this URL: <https://echa.europa.eu/guidance-documents/guidance-on-reach>

Compatible Parts



TE Part # CAT-D9934-A75B
Receptacle and Tab Housing: 5.08 mm Pitch, 250-600V



TE Part # CAT-D9934-A75A
Receptacle and Tab Housing: 3.81 mm pitch, 250V



TE Part # CAT-D9934-A75C
Receptacle and Tab Housing: 5.08 mm pitch, 600V



TE Part # 91560-1
CCII D-3 2L REC TAB 16-14 ASSY



Also in the Series | Dynamic 3000 Series

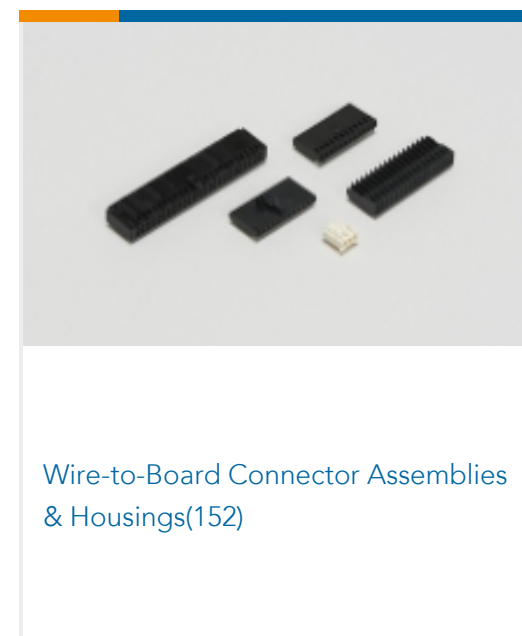
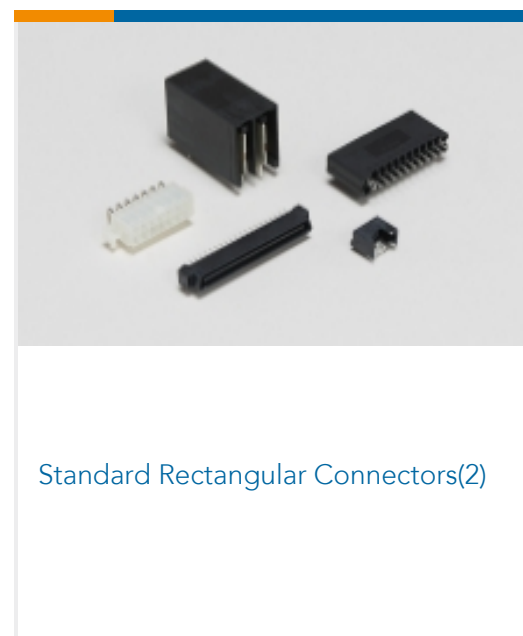
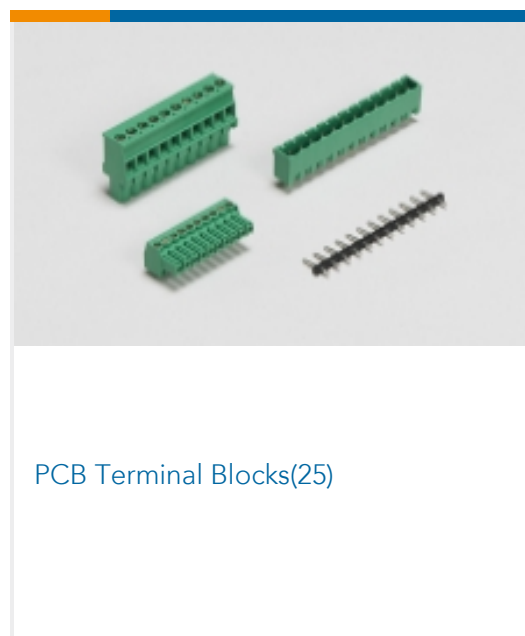
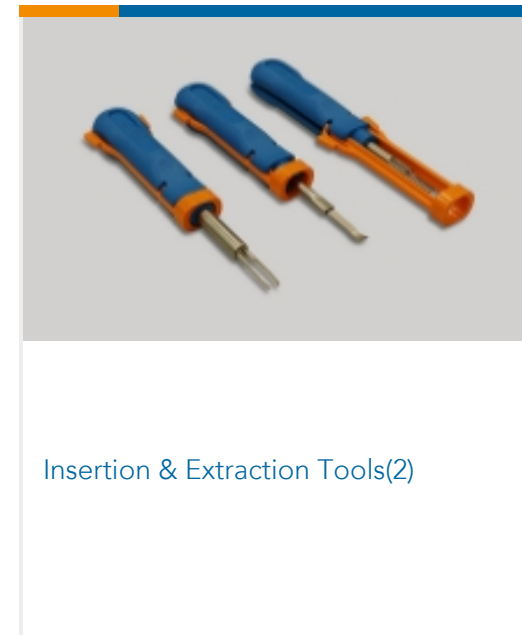
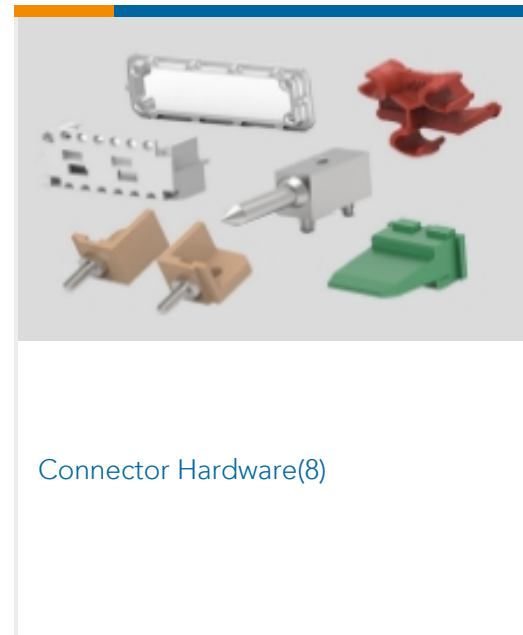
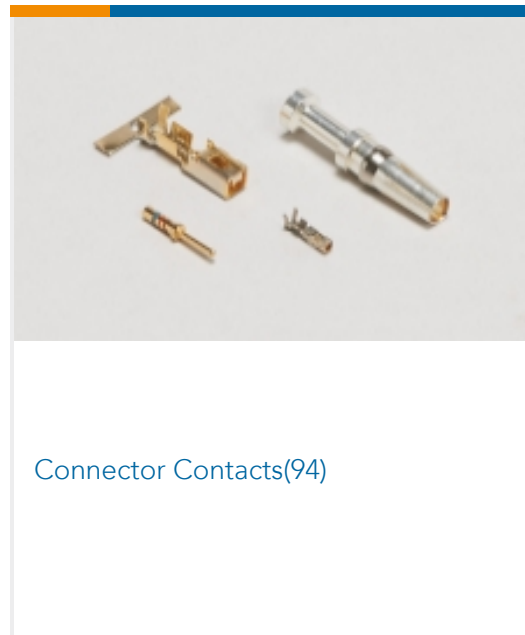

Customers Also Bought

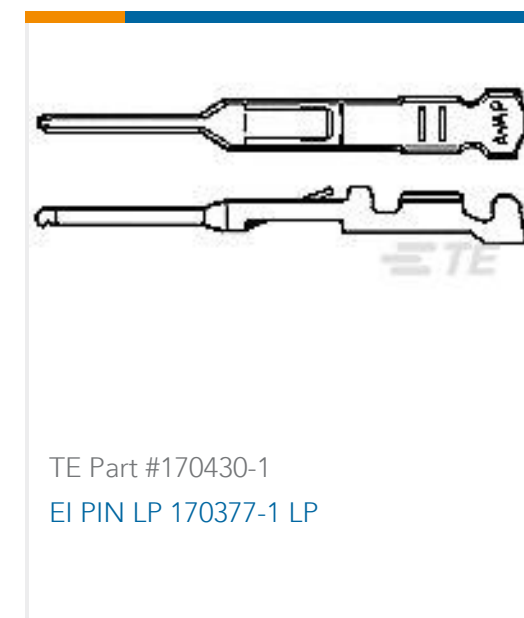



Documents

Product Drawings

[DYNAMIC D-3 REC CONT. 2L AU 0.38 L/P](#)

English

CAD Files

[3D PDF](#)

3D

Customer View Model

[ENG_CVM_CVM_917511-2_C.2d_dxf.zip](#)

English

Customer View Model

[ENG_CVM_CVM_917511-2_C.3d_igs.zip](#)

English

Customer View Model

[ENG_CVM_CVM_917511-2_C.3d_stp.zip](#)

English

By downloading the CAD file I accept and agree to the [Terms and Conditions](#) of use.

Datasheets & Catalog Pages

[1-1773732-4_DYNAMIC_SERIES_CATALOG_ENGLISH](#)

Japanese

[1-1773732-4_DYNAMIC_SERIES_CATALOG_ENGLISH](#)

English

Product Specifications

[Application Specification](#)

English

Instruction Sheets

[Instruction Sheet \(non U.S.\)](#)

Japanese

[Instruction Sheet \(non U.S.\)](#)

English

[Instruction Sheet \(non U.S.\)](#)

Japanese

[MULTIPLE ENCLOSURE 67M D1200 15POS. REC PLUG](#)

Japanese

Agency Approvals

[TUV Certificate](#)

English

[TUV Certificate](#)

English

917511-2

Receptacle Contact, Gold, 16 – 14 AWG Wire Size, 1.23 – 2.27 mm² Wire Size, Power & Signal, -67 – 221 °F [-55 – 105 °C], Dynamic 3000 Series

