



TAOGLAS®



Datasheet

Bolt

Part No:
A.90.A.101111

Description:

Bolt – High Gain Low Profile
GPS/QZSS (L1), Galileo (E1), GLONASS (G1), BeiDou (B1)
Permanent Mount Antenna with High Out of Band Rejection

Features:

30dB GPS Gain, 25dB GLONASS Gain
Rejection: >80dB@850/900MHz,
>65dB@1800/1900MHz
Lightning Induced Surge Protection
IEC 61000-4-5 (Class 4) 4kV
Wideband Input Voltage
Permanent (Screw) Mount
Low Profile, Vandal Resistant Design
IP67 Rated, UV Resistant Enclosure
Cable: 1m RG-174
Connector: SMA (M) ST
Dimensions: Diameter: 94.3mm, Height: 25.4mm
RoHS & Reach Compliant

1. Introduction	3
2. Specifications	4
3. Antenna Characteristics	6
4. Radiation Patterns	12
5. Field Test Section	14
6. Mechanical Drawing	15
7. Packaging	16
<hr/>	
Changelog	18

Taoglas makes no warranties based on the accuracy or completeness of the contents of this document and reserves the right to make changes to specifications and product descriptions at any time without notice. Taoglas reserves all rights to this document and the information contained herein. Reproduction, use or disclosure to third parties without express permission is strictly prohibited.



1. Introduction



The Bolt, A.90 is a high gain GNSS L1 (GPS/GLONASS) antenna that features very high out of band rejection and can handle large bursts of power from nearby transmitters. These characteristics make the A.90 ideal for applications where the antenna will be placed near high-power transmitters, such as cellular base stations or radar systems.

The A.90 utilizes a very high efficiency (>78%) patch antenna that has been tuned for best possible performance within the enclosure to maximize signal quality. A ceramic dielectric filter is placed between the antenna and the LNAs to absorb large out-of-band bursts of power from nearby transmitters while minimizing in-band insertion loss. The internal LNAs have very low noise figure to maintain excellent signal quality throughout the entire signal chain. The signal chain also features carefully selected and placed SAW filters that collectively allow for very sharp signal attenuation outside of the intended frequency bands without negatively impacting in-band signal quality.

The A.90 features excellent rejection across all non-GNSS frequencies to prevent overdriving or damaging your GPS receiver. At the 850/900MHz cellular bands, for example, the A.90 exhibits greater than 80dB of rejection. At the 1800/1900MHz cellular bands, it exhibits >65dB, making it best in class when out of band interference is a concern. Even with this excellent out of band attenuation, the A.90 maintains a low noise figure of 3.7dB and high gain of >25dB, making it an ideal solution for applications with longer cable runs where high cable loss is a concern. The A.90 also features protection against lightning induced surges that are common in tower equipment, according to IEC 61000-4-5 (Class 4) 4kV.

Cable lengths and connector types are customizable. Contact your regional Taoglas customer support team for more information.

2. Specifications

GNSS Frequency Bands Covered						
GPS	L1	L2	L5			
	■	□	□			
GLONASS	G1	G2	G3			
	■	□	□			
Galileo	E1	E5a	E5b	E6		
	■	□	□	□		
BeiDou	B1	B2a	B2b	B3		
	■	□	□	□		
QZSS (Regional)	L1	L2C	L5	L6		
	■	□	□	□		
IRNSS (Regional)	L5					
	□					
SBAS	L1/E1/B1	L5/B2a/E5a	G1	G2	G3	
	■	□	■	□	□	

■ GNSS Frequency Bands Covered. □ GNSS Frequency Bands Not Covered.

*SBAS systems: WASS(L1/L5), EGNOS(E1/E5a), SDCM(G1/G2/G3), SNAS(B1,B2a), GAGAN(L1/L5), QZSS(L1/L5), KAZZ(L1/L5).

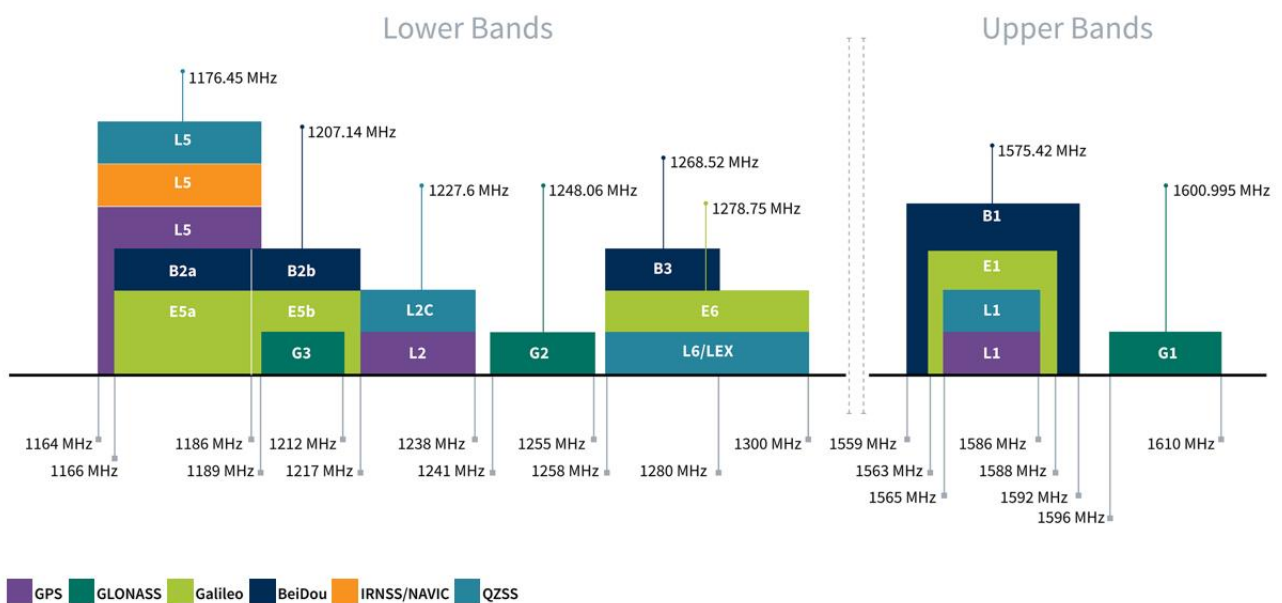

GNSS Bands and Constellations

GNSS Electrical		
Frequency (MHz)	1575.42	1602
Return Loss (dB)	<-10	<-10
Efficiency (%) (Without cable loss)	60.81	65.76
Peak Gain (dBi) (Without cable loss)	3.59	4.05
Average Gain (dB) (Without cable loss)	-2.16	-1.96
Axial Ratio (dB)	6.7	6.7
Group Delay	65	65
PCO (cm)	1.29	0.73
PCV (cm)	0.99	0.9
Polarization	RHCP	
Impedance	50Ω	
LNA and Filter Electrical Properties		
Frequency (MHz)	1575.42	1602
Return Loss (dB)	<-10	<-10
Gain@3.3V (dB Typ.)	30.08	25.99
Noise@3.3V (dB Typ.)	3.76	3.70
Power consumption@3.3V (mA Typ.)	15	
Phase Centre Offset(mm)	<1.3	
Field Test Result		
RTK Accuracy(cm)	1.5	
CN Value(dB-Hz)	40+ Typ	
Non RTK Accuracy(cm)	67	
Mechanical		
Dimension(mm)	Diameter:94.3, Height:25.4	
Housing	ASA	
Cable	1m RG-174 SMA(M)	
Connector	SMA(M)	
Weight	175g	
Environmental		
Protection	IP67	
Temperature Range	-40°C to 85°C	
Humidity	Non-condensing 65°C 95% RH	

3. Antenna Characteristics

3.1 Test Setup – Free Space



3.2 Return Loss

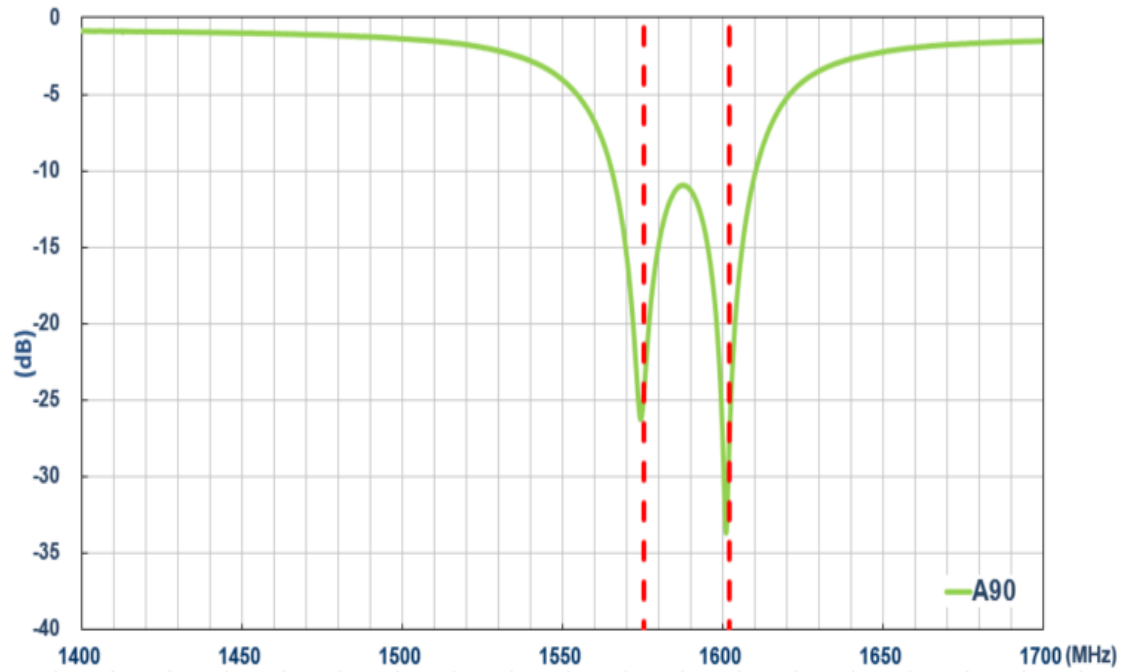

3.3 Efficiency

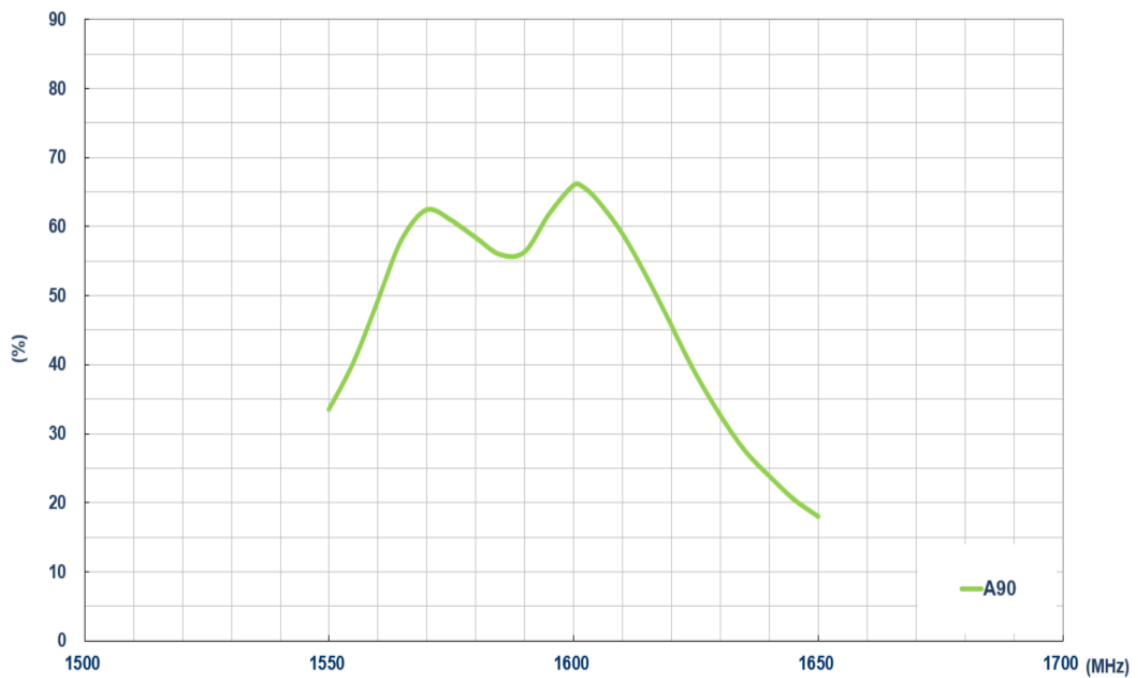

3.4 Average Gain

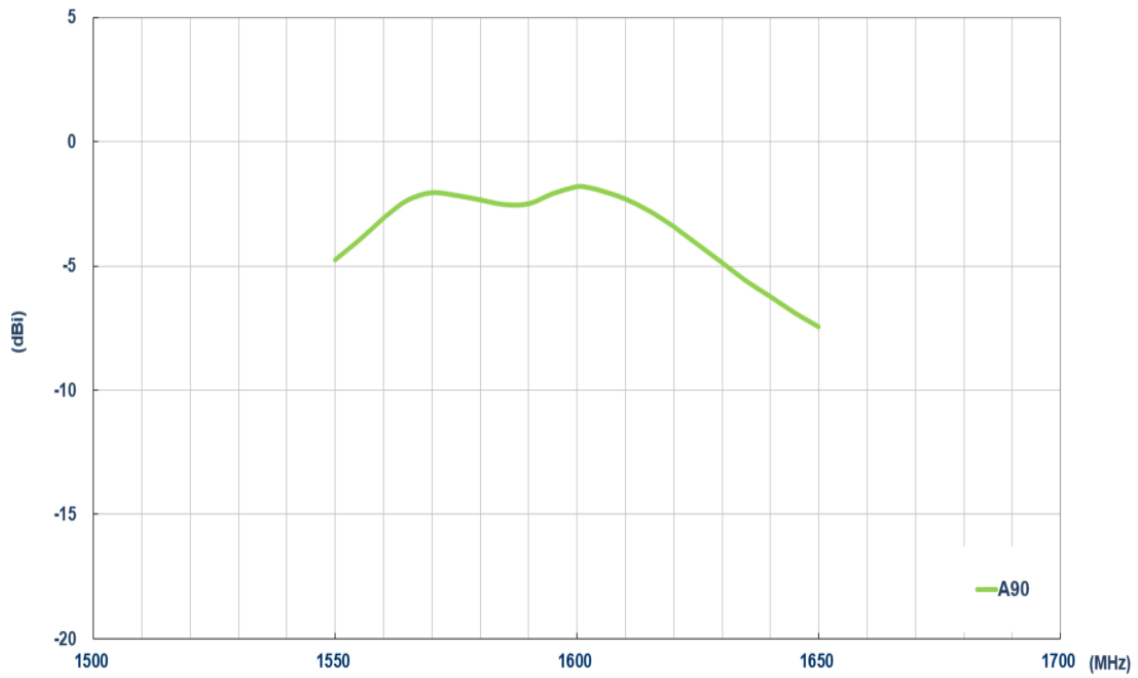

3.5 Peak Gain

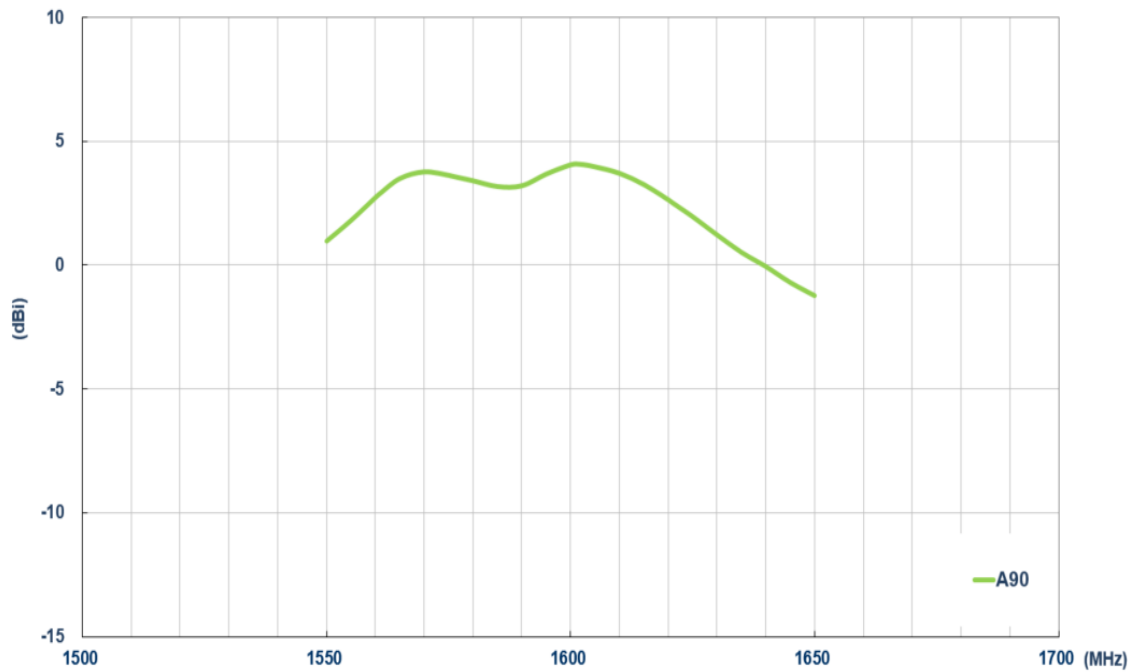

3.6 Axial Ratio @ 1575.42MHz, Phi=0

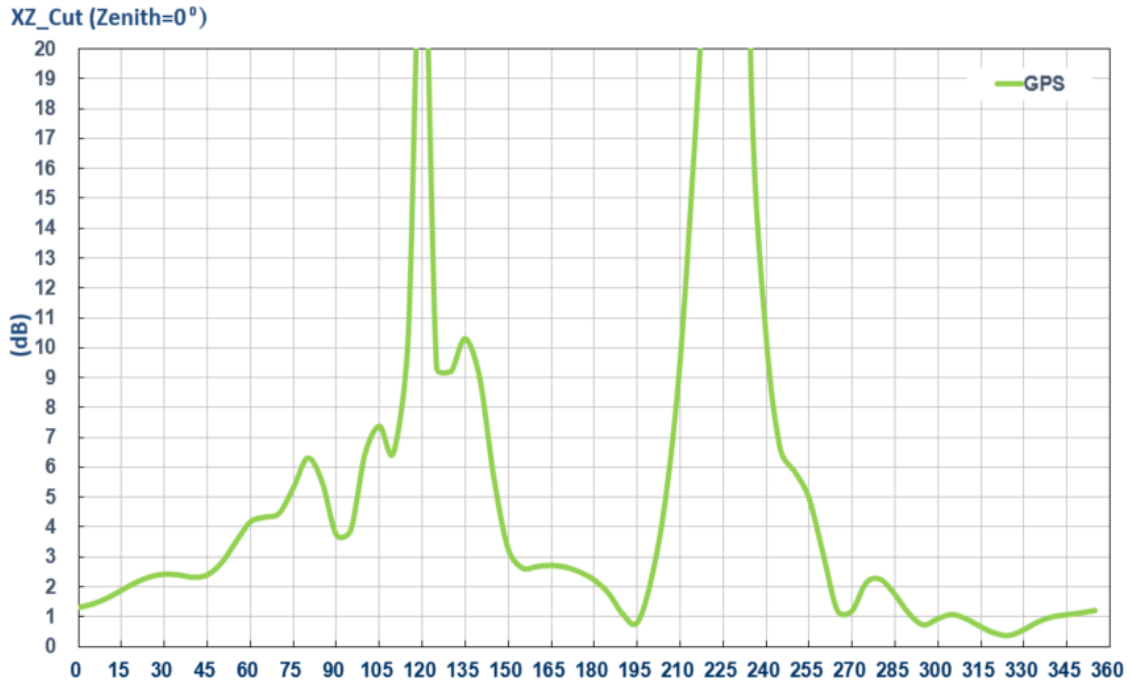

3.7 Axial Ratio @ 1602MHz, Phi=0

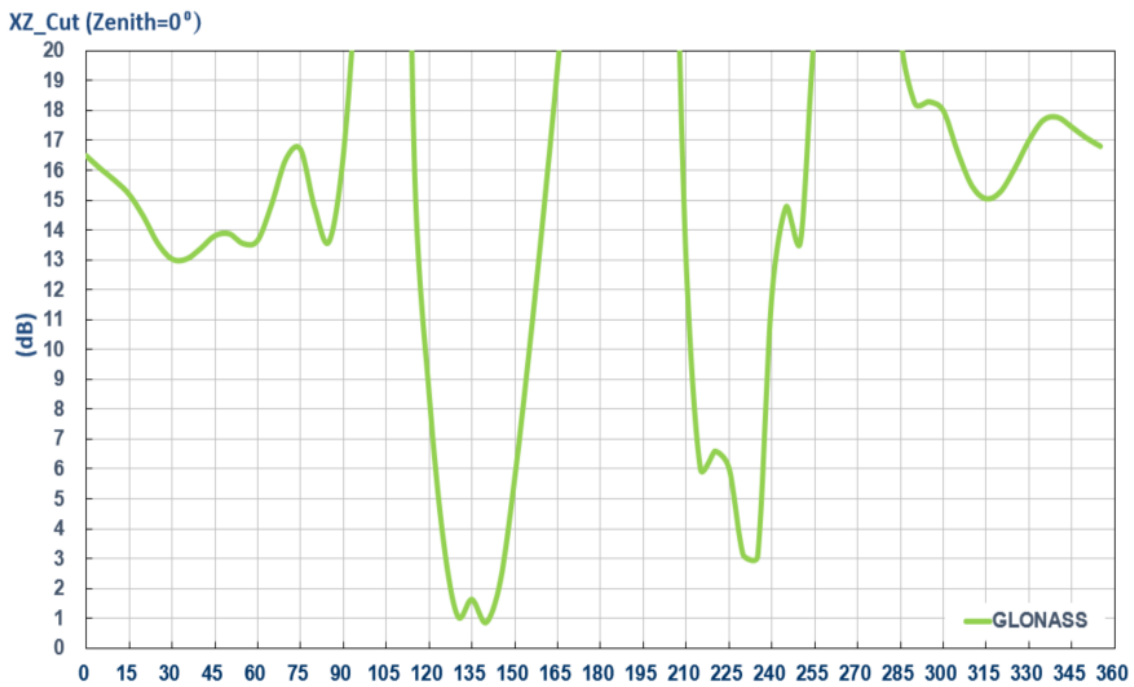

3.8 LNA Gain and Noise Figure @ 3.3V

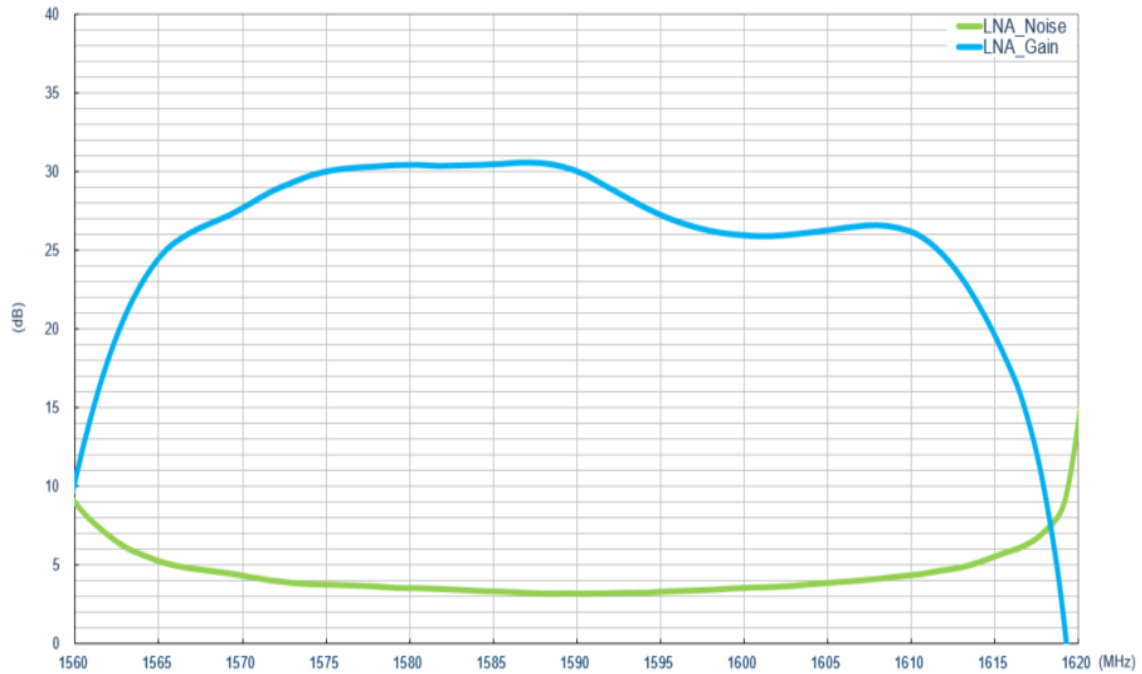

3.9 Out of band Rejection 0.1GHz to 6GHz

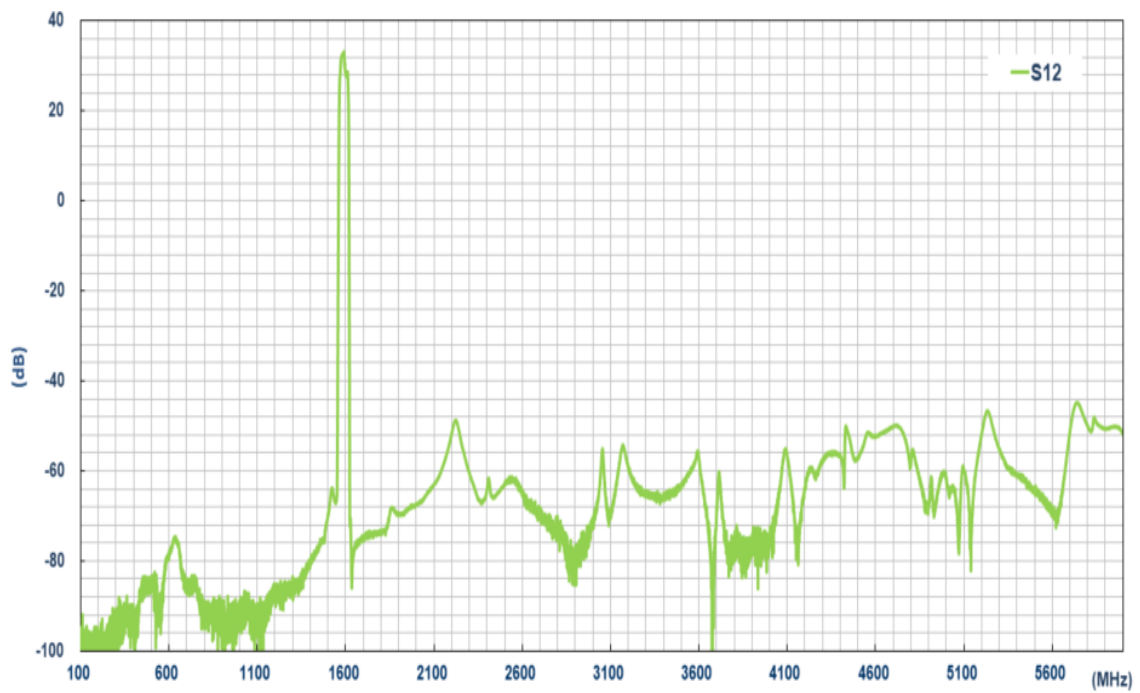

3.10 Out of band Rejection 1.4GHz to 1.7GHz

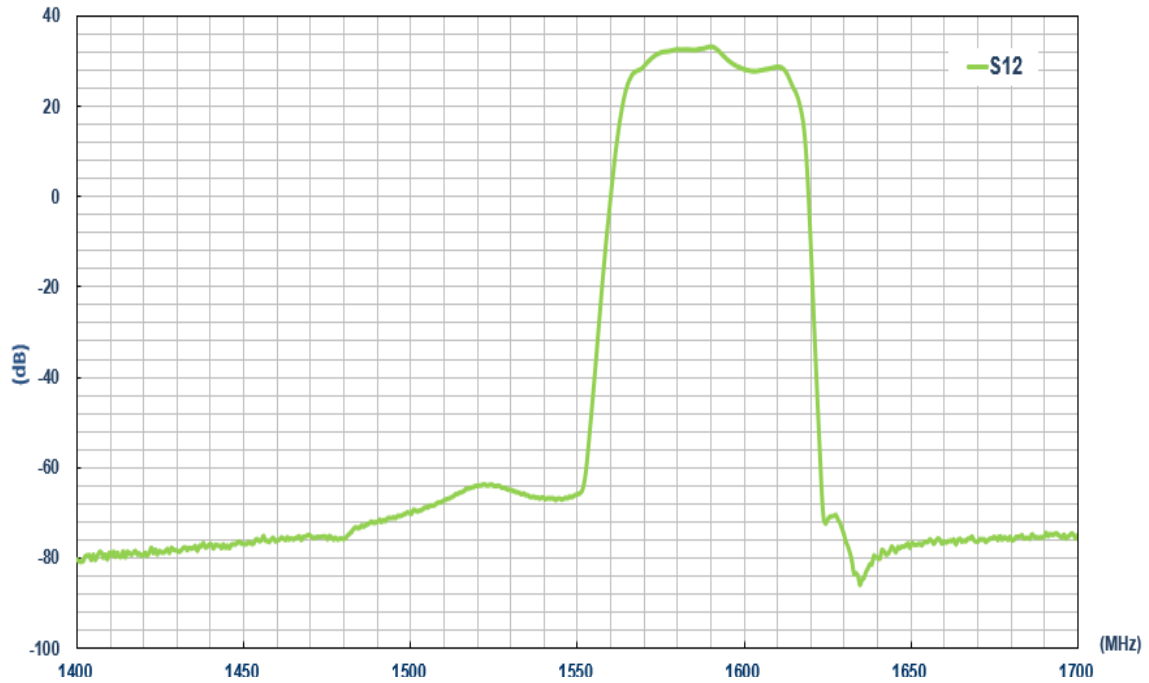

4. Radiation Patterns

4.1 1575.42MHz 3D and 2D Radiation Patterns

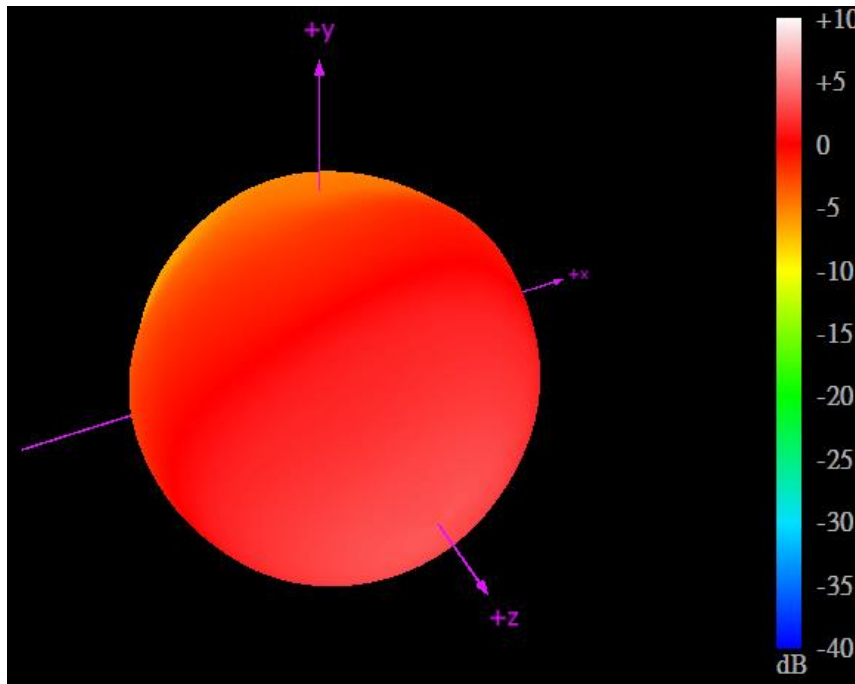

XY Plane

XZ Plane

YZ Plane

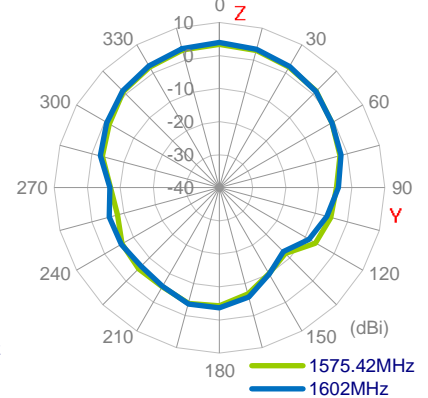
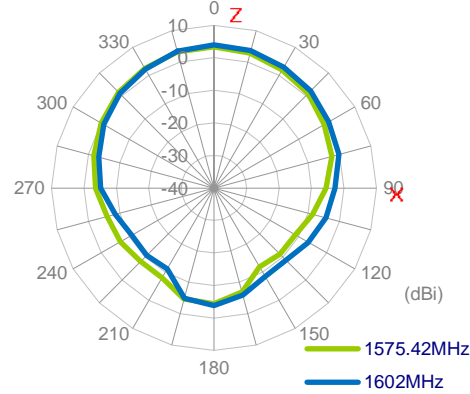
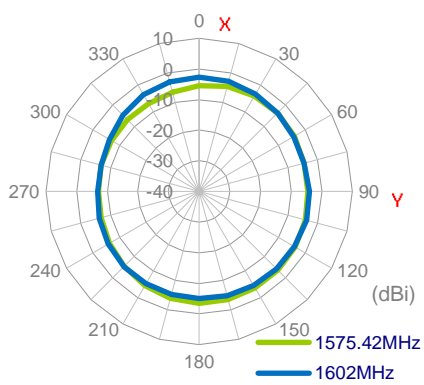

4.2 1602MHz 3D and 2D Radiation Patterns

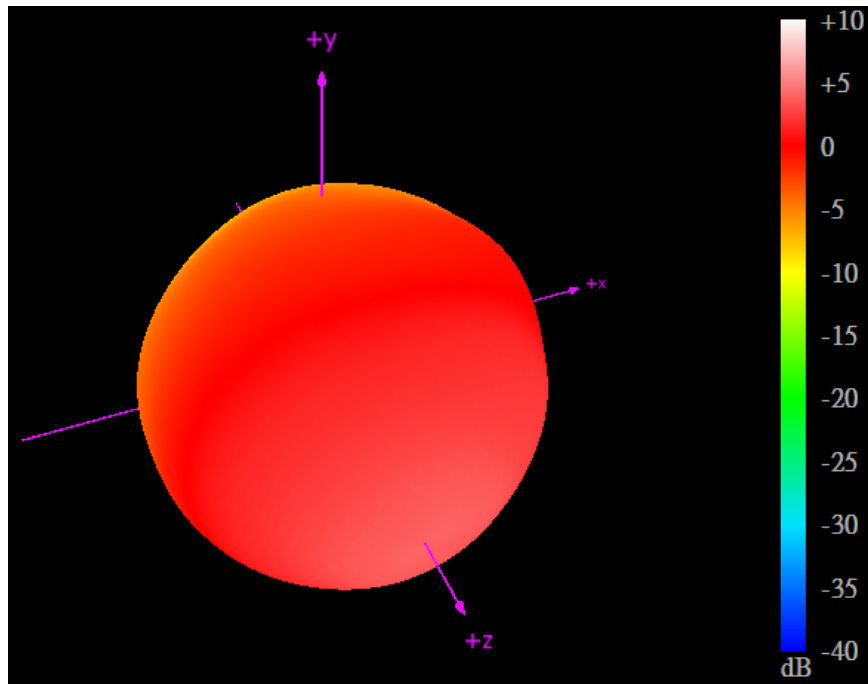

XY Plane XZ Plane YZ Plane

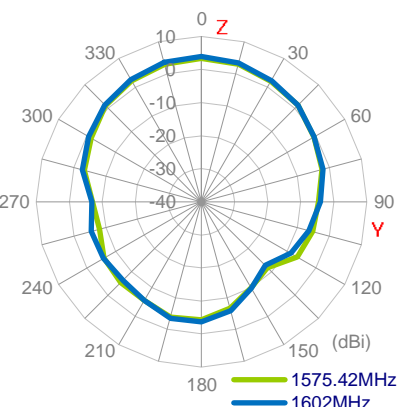
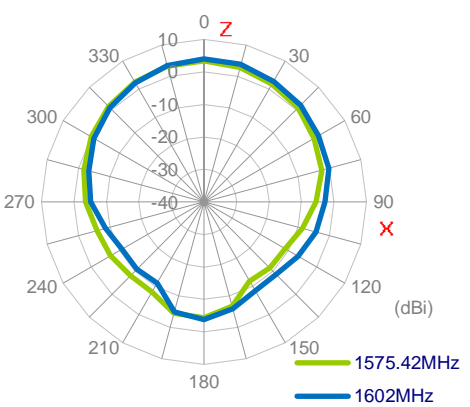
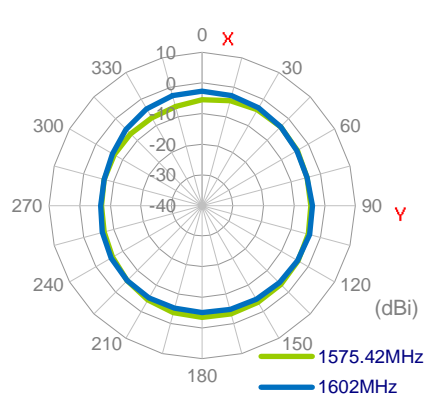

5. Field Test Results

5.1 Rooftop test

In this section Taoglas will present the field test result for A90 antenna. The test was performed when the antenna was mounted on a static rooftop test set up in an open sky environment for at least **6 hours**.

Taoglas will show the field test results using the following receiver:

1. U-blox ZED-F9P

Receiver features:

- Multi-band GNSS: 184-channel GPS L1C/A L2C, GLONASS: L1OF L2OF, Galileo: E1B/C E5b, BeiDou: B1I B2I, QZSS: L1C/A L2C
- Multi-band RTK with fast convergence times and reliable performance
- Nav. update rate RTK up to 20 Hz
- Position accuracy = RTK 0.01 m + 1 ppm CEP

Positioning Accuracy Table (2D Accuracy)					
Test Condition	Correction Service	CEP (50%)	DRMS (68%)	2DRMS (95-98.2%)	TTF (sec)
Free Space	RTK DISABLED	59.46 cm	78.85 cm	157.71 cm	23.9
	RTK ENABLED	2.91 cm	3.82 cm	7.65 cm	23.9
30x30 cm Ground Plane	RTK DISABLED	57.03 cm	68.82 cm	137.64 cm	24.5
	RTK ENABLED	0.99 cm	1.19 cm	2.37 cm	24.5

RTK Availability
Free Space

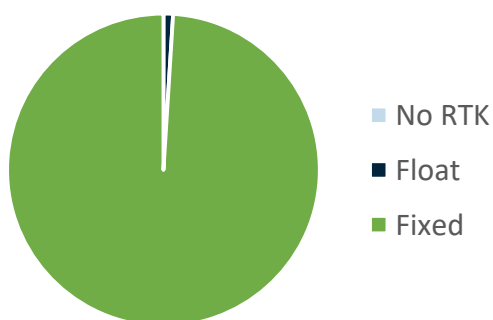

RTK Availability
30x30 cm ground plane

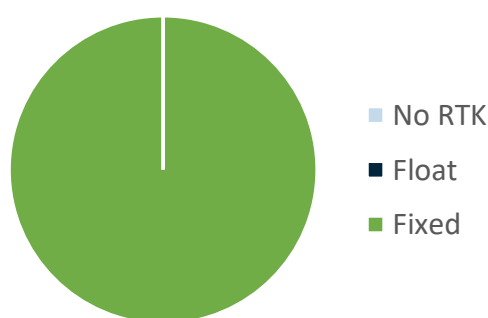

6. Mechanical Drawing (Units: mm)

6	5	4	3	2	1		
ISO NO: EDW-18-8-xxxx		<Release>					
		REV	ZONE	DESCRIPTION	ENG	APPROVED	ISSUED DATE
		ALL		Initial Design	Bonnie	Paul	2018/03/05
		ALL		Change Label to Print Heat Shrink Tube. Modify Tolerances and BOM. (ZZR-18-8-008)	Rachel	Haley	2018/10/15

Top View

Bottom Thread View

Epoxy
Cable Outlet

Front View

Name	P/N	Material	Finish	QTY
1 A.90 Housing	000116J030000A	ASA	Black	1
2 Double Sided Adhesive(Black Foam)	001015C020000A	3M9448+CR4305	White Liner	1
3 Mini ST Base	000314K000092A	Zinc Alloy	Ni Plated	1
4 Nut_M20x1.5Px10H Cut	000413E030061A	Steel	Zn-Ni Plated	1
5 Washer_Cut	000413E040061A	Steel	Zn-Ni Plated	1
6 Cable Rubber_ST_6N1	000713K000064A	Silicone Rubber	Black	1
7 Heat Shrink Tube (GNSS)	001318C000000A	PE	Blue Tube/White Text	1
8 A.90 Label	001017E000000A	PET	White/Black Text	1
9 RG174 Cable Type	301315C000000A	PVC	Black	1
10 SMA(M)ST	200218D000098A	Brass	Au Plated	1

UNLESS OTHERWISE SPECIFIED
TOLERANCES ON:
.X± 0.2
XX± 0.5 .XX± 0.1
X.X± 0.3 .XXX± 0.05

APPROVED BY: **Paul**
CHECKED BY: **Jack**
DRAWN BY: **Bonnie**

DATE: 2018/03/05
UNIT: mm
THIRD ANGLE PROJECTION

MAT'L:
FINISH:
SCALE: 1/2

taoglas
antenna solutions TW Design Centre
This drawing and its inherent design concepts are property of Taoglas. Not to be copied or given to third parties without the written consent of Taoglas.

TITLE : Bolt - Low Profile High RF Immunity Timing GNSS L1 Antenna with 1M RG-174 & SMA(M)ST

PART NO. : A.90.A.101111

6	5	4	3	2	1
---	---	---	---	---	---

7. Packaging

7.1 A.90.A.101111(Individual Packaging)

1 A.90.A.101111 per PE bag
 Bag Dimensions - 232*183mm
 Total Weight - 250g

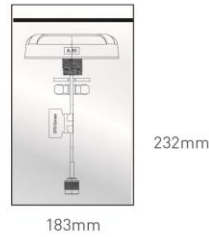

1 pcs / PE bags per Inner Carton
 Inner Carton Dimensions - 117*109*58mm
 Weight - 310g

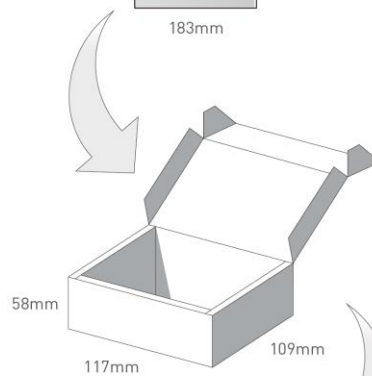

25 Inner Cartons per Outer Carton
 Carton Dimensions - 589*296*135mm
 Weight - 8Kg

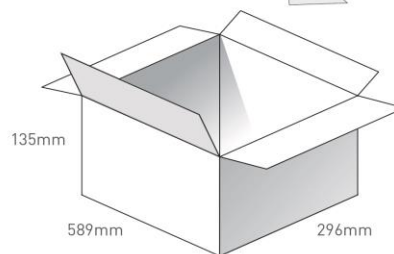

Pallet Dimensions 1200*1000*1420mm
 54 Cartons per pallet
 6 Cartons per layer
 9 Layers

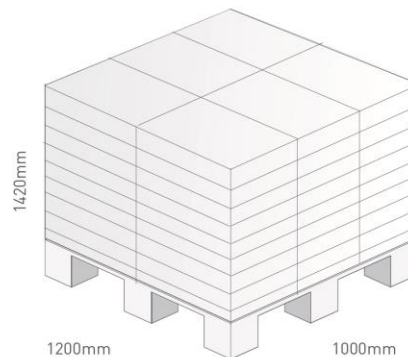

7.2 A.90.A.101111(Bulk Packaging Packaging)

1 A.90.A.101111.bp per PE bag
 Bag Dimensions - 232*183mm
 Total Weight - 250g

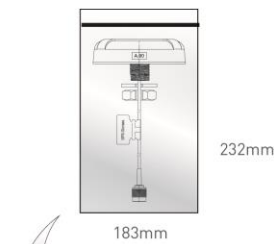

50 pc per Carton in bulk packaging
 Carton Dimensions - 600*340*245mm
 Weight - 13Kg

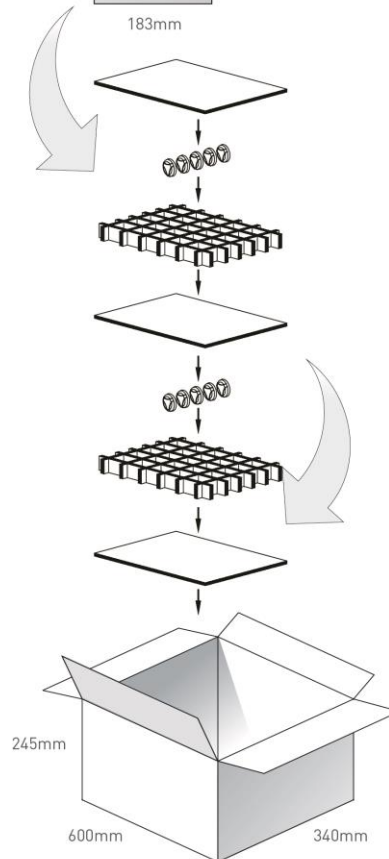

Pallet Dimensions 1200*1000*1430mm
 20 Cartons per pallet
 4 Cartons per layer
 5 Layers

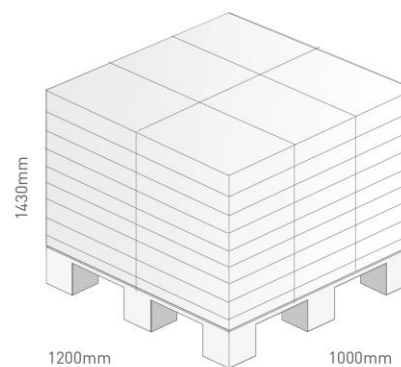

Changelog for the datasheet

SPE-18-8-037 – A.90.A.101111

Revision: E (Current Version)

Date:	2020-06-04
Changes:	Added Field test Results
Changes Made by:	Victor Pinazo

Previous Revisions

Revision: D

Date:	2020-01-14
Changes:	Updated Template
Changes Made by:	Yu Kai Yeung

Revision: C

Date:	2019-12-08
Changes:	Out of band rejection added
Changes Made by:	David Connolly

Revision: B

Date:	2017-12-10
Changes:	Updated Drawing
Changes Made by:	Jack Conroy

Revision: A (Original First Release)

Date:	2017-08-10
Notes:	Initial Datasheet release
Author:	Jack Conroy



TAOGLAS®

www.taoglas.com

