



MATE-N-LOK | Universal MATE-N-LOK

TE Internal #: 926299-5

Rectangular Power Connectors, Housing, Plug, Wire-to-Wire, 5 Position, 6.35 mm [.25 in] Centerline, Wire & Cable, UL 94V-0, Universal MATE-N-LOK

[View on TE.com >](#)

Connectors > Power Connectors > Rectangular Power > Rectangular Power Connectors



Rectangular Power Connector Type: **Housing**

Connector & Housing Type: **Plug**

Connector System: **Wire-to-Wire**

Number of Positions: **5**

Centerline (Pitch): **6.35 mm [.25 in]**

Features

Product Type Features

Rectangular Power Connector Type	Housing
Connector & Housing Type	Plug
Connector System	Wire-to-Wire
Sealable	No
Connector & Contact Terminates To	Wire & Cable

Configuration Features

Number of Positions	5
Number of Rows	1

Electrical Characteristics

Operating Voltage	600 VAC
-------------------	---------

Contact Features

Multiple Contact Types	Without
Contact Layout	Inline
Contact Retention Within Housing	Without



Contact Type	Socket
--------------	--------

Termination Features

Termination Method to Wire & Cable	Crimp
------------------------------------	-------

Mechanical Attachment

Connector Mounting Type	Cable Mount (Free-Hanging)
-------------------------	----------------------------

Housing Features

Centerline (Pitch)	6.35 mm [.25 in]
--------------------	------------------

Housing Color	Natural
---------------	---------

Housing Material	PA 6 GF
------------------	---------

Usage Conditions

Operating Temperature Range	-55 – 125 °C [-67 – 257 °F]
-----------------------------	-----------------------------

Operation/Application

Circuit Application	Power & Signal
---------------------	----------------

Industry Standards

UL Rating	Recognized
-----------	------------

Compatible With Agency/Standards Products	UL, VDE
---	---------

Compatible With Approved Standards Products	UL E28476
---	-----------

UL Flammability Rating	UL 94V-0
------------------------	----------

Glow Wire Rating	GWT 750°C (Without Flame)
------------------	---------------------------

Packaging Features

Packaging Quantity	1000
--------------------	------

Packaging Method	Bag & Box
------------------	-----------

Product Compliance

[For compliance documentation, visit the product page on TE.com>](#)

EU RoHS Directive 2011/65/EU	Compliant
------------------------------	-----------

EU ELV Directive 2000/53/EC	Compliant
-----------------------------	-----------

China RoHS 2 Directive MIIT Order No 32, 2016	No Restricted Materials Above Threshold
---	---

EU REACH Regulation (EC) No. 1907/2006	Current ECHA Candidate List: JUNE 2023 (235) Candidate List Declared Against: JUNE 2023 (235) Does not contain REACH SVHC
--	---



Halogen Content	Not Low Halogen - contains Br or Cl > 900 ppm.
-----------------	--

Solder Process Capability	Not applicable for solder process capability
---------------------------	--

Product Compliance Disclaimer

This information is provided based on reasonable inquiry of our suppliers and represents our current actual knowledge based on the information they provided. This information is subject to change. The part numbers that TE has identified as EU RoHS compliant have a maximum concentration of 0.1% by weight in homogenous materials for lead, hexavalent chromium, mercury, PBB, PBDE, DBP, BBP, DEHP, DIBP, and 0.01% for cadmium, or qualify for an exemption to these limits as defined in the Annexes of Directive 2011/65/EU (RoHS2). Finished electrical and electronic equipment products will be CE marked as required by Directive 2011/65/EU. Components may not be CE marked. Additionally, the part numbers that TE has identified as EU ELV compliant have a maximum concentration of 0.1% by weight in homogenous materials for lead, hexavalent chromium, and mercury, and 0.01% for cadmium, or qualify for an exemption to these limits as defined in the Annexes of Directive 2000/53/EC (ELV). Regarding the REACH Regulation, the information TE provides on SVHC in articles for this part number is based on the latest European Chemicals Agency (ECHA) 'Guidance on requirements for substances in articles' posted at this URL: <https://echa.europa.eu/guidance-documents/guidance-on-reach>

Compatible Parts

 <p>TE Part # 350810-1 05P UMNL CAP HSG</p>	 <p>TE Part # 350779-4 04P UMNL PLUG HSG UL94VO</p>	 <p>TE Part # 926299-3 5P UN-MNL STECKGEH</p>	 <p>TE Part # 1-480764-0 05P UMNL CAP HSG NATL</p>
 <p>TE Part # 926298-3 04P UNIV.M-N-L.PLUG</p>	 <p>TE Part # 2-480702-0 04P UMNL PLUG HSG NATL</p>	 <p>TE Part # 350779-1 04P UMNL PLUG HSG</p>	 <p>TE Part # 350720-4 09P UMNL PLUG HSG UL94VO</p>
 <p>TE Part # 1-480702-0 04P UMNL PLUG HSG NATL</p>	 <p>TE Part # 1-1703061-2 PLUG, 2 CIRCUIT , UNIVERSAL MATE-N-LOK</p>	 <p>TE Part # 480764-9 05P UMNL CAP HSG BLK</p>	 <p>TE Part # 350809-3 05P UMNL PLUG HSG</p>



Also in the Series | **Universal MATE-N-LOK**

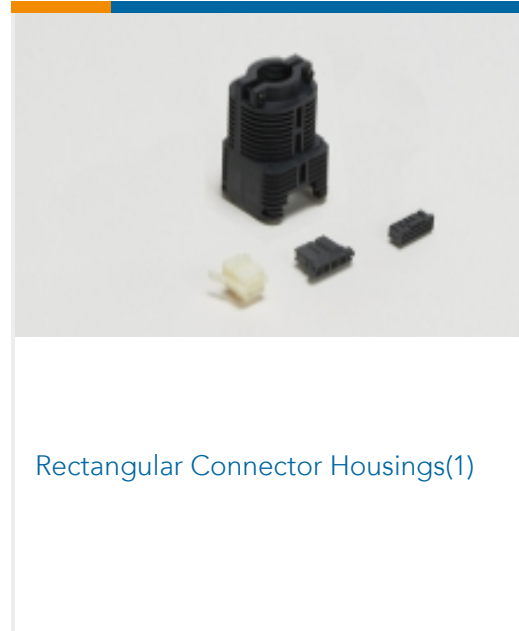
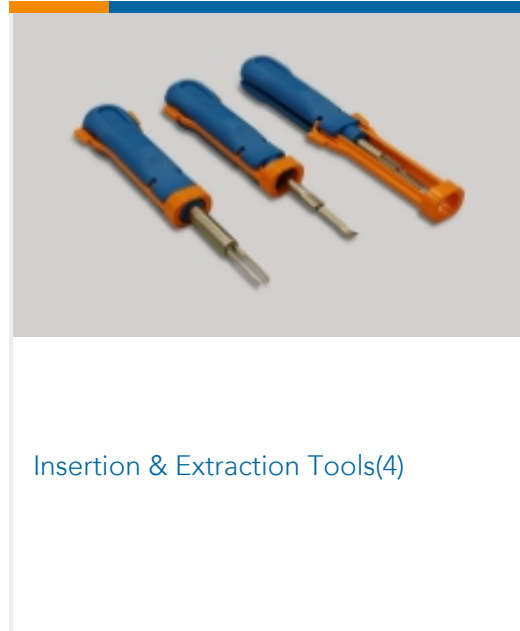
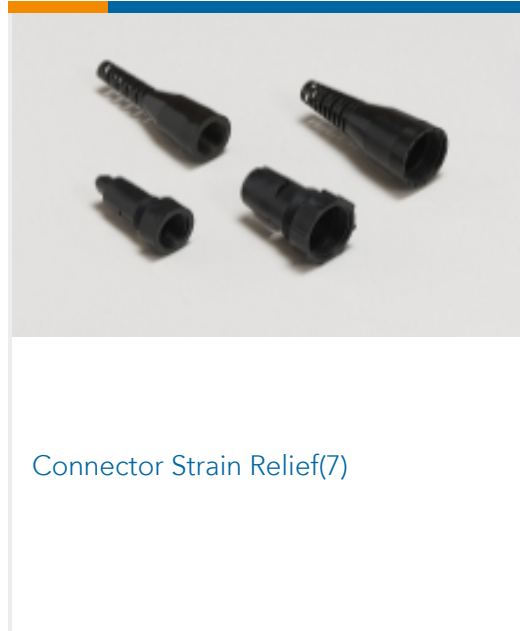
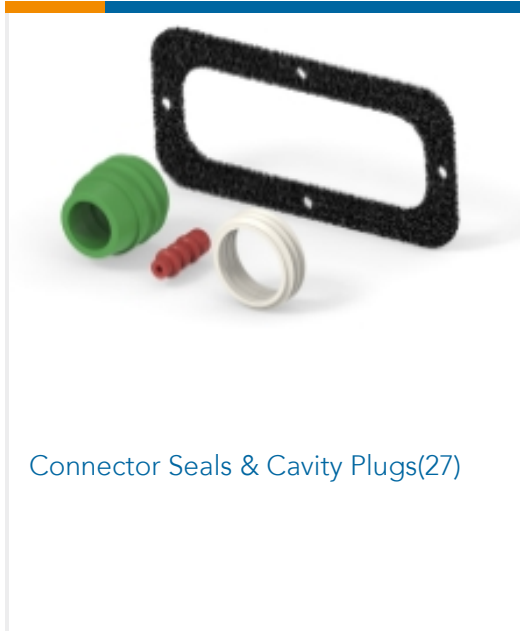
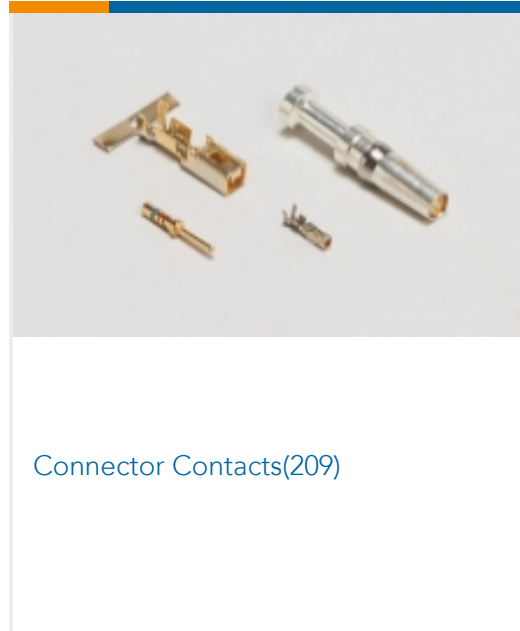
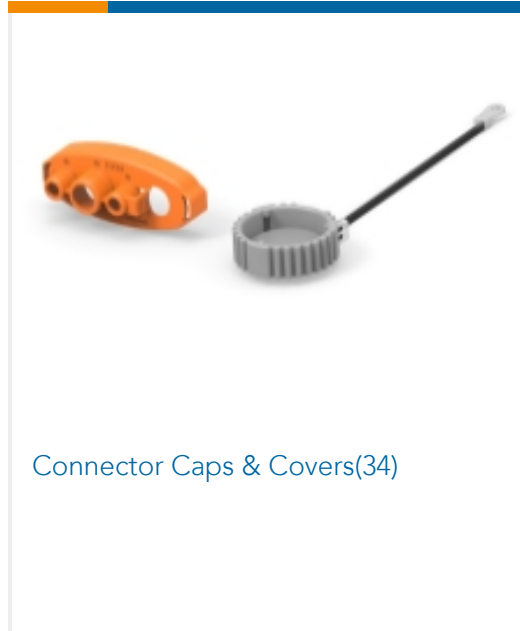
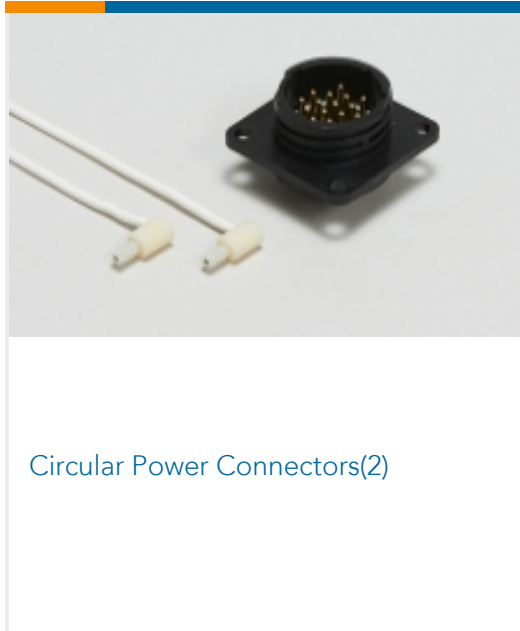

Customers Also Bought

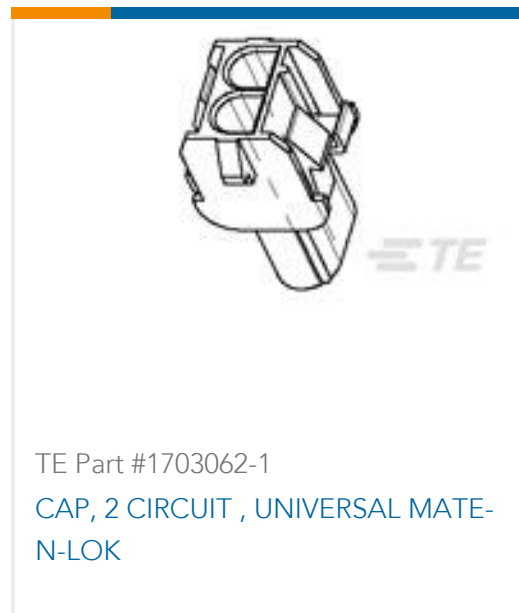



TE Part #42100-2
FF 250 REC 18-14AWG TPBR



TE Part #62553-3
FF 250 TAB 22-18AWG TPBR



TE Part #350851-1
UMNL SOK 24-18 PTPBR



TE Part #180984
FASTON 250 BOOT FLAG NYLON
NAT



TE Part #1863005-1
12P UMNL PLUG HSG



TE Part #140664
RECTANGULAR 112 18-14 .236 X .394
TPBR

Documents

Product Drawings

UNML PLUG 5WAY

English

CAD Files

3D PDF

3D

Customer View Model

[ENG_CVM_CVM_926299-5_G_c-926299-5-g.2d_dxf.zip](#)

English

Customer View Model

[ENG_CVM_CVM_926299-5_G_c-926299-5-g.3d_igs.zip](#)

English

Customer View Model

[ENG_CVM_CVM_926299-5_G_c-926299-5-g.3d_stp.zip](#)

English

By downloading the CAD file I accept and agree to the [Terms and Conditions](#) of use.

Datasheets & Catalog Pages

[2_PIECE_POWER_CONNECTORS_qrg_4-1773458-1](#)

English

Product Specifications

Application Specification

German

Agency Approvals

VDE Certificate

926299-5

Rectangular Power Connectors, Housing, Plug, Wire-to-Wire, 5 Position, 6.35 mm [.25 in] Centerline, Wire & Cable, UL 94V-0, Universal MATE-N-LOK



English