

REV.	Q'TY	ECN. NO.	APR.	DATE

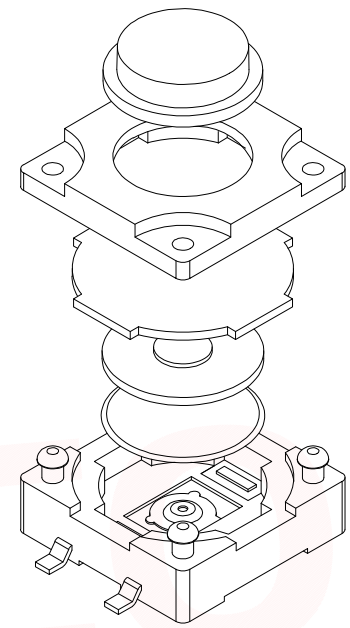

The Main Thchnology Performance

Rate voltage,current	50mA DC12V
Contact resistance	≤100mΩ
Operating force	±30gf
Travel	0.30±0.10mm
Insulated resistance	>100MΩ
Dielectric strength	>250VAC/1min
IP rating	IP67

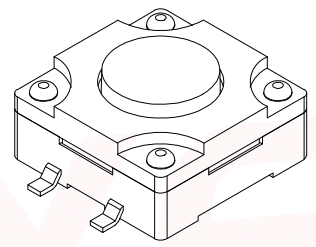
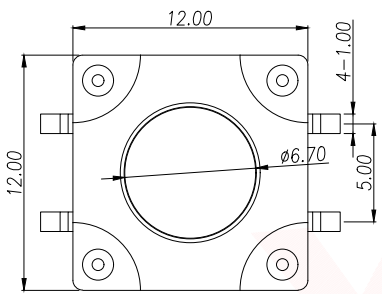
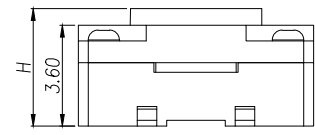
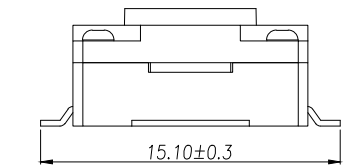
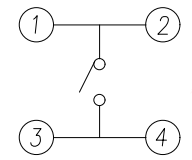

CIRCUIT DIAGRAM

ITEM	DESCRIPTION	MATERIAL	QTY	FINSH/COLOR
G	按钮	PPA	1	黑色
F	盖板	PPA	1	黑色
E	防尘胶	硅胶	1	黑色
D	内嵌	PPA	1	黑色
C	弹片	磷铜/不锈钢	1	镀镍
B	本件	PPA	1	黑色
A	卡件	黄铜	1	镀镍

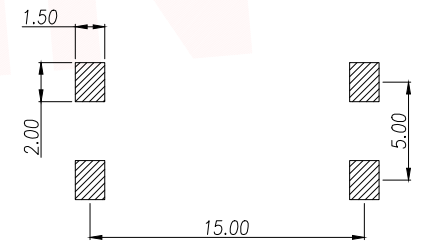

PCB.WELDING DRAWING

T S O 1 8 A - T B Y 1

力度: F: 250G E: 180G
 高度: H4.3 H4.5

H	H	H
4.3	6.5	9.5
4.5	7.0	10.0
4.8	7.5	10.5
5.0	8.0	11.0
5.5	8.5	11.5
6.0	9.0	12.0

DIMENSION IN mm		TOLERANCE UNLESS OTHERWISE SPECIFIED		厦门市辛译精密电子有限公司 Xiamen XinYi Xyecomm Electronics Co.,Ltd	
.X±0.35	X.*± 5*	APR.	Alex	TITLE: 12x12 SMD TACT SWITCH	
.XX±0.25	.X*± 3*	CHK.	Jack	DWG NO. TS018A-TBY1FHX	
.XXX±0.15	.XX*± 1*	DRA.	Can	PROJ. CUSTOMER DRAWING	
SIZE A4	SCALE 1:1	SHEET 1/1	REV. A		