

NOTES:

1. Rating: 2.5A 250VAC (UL, CUL)
2. Contact resistance: 50mΩ Max
3. Insulation resistance: >100MΩ Min 500VDC
4. Dielectric strength: >2000VAC 0.5mA 1 minutes

TEL: 0769-82320511-867

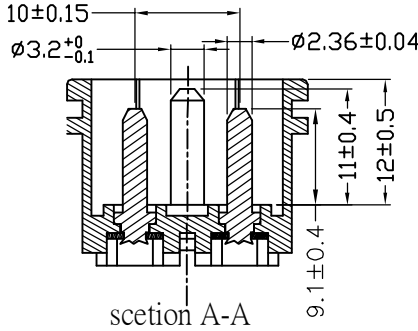
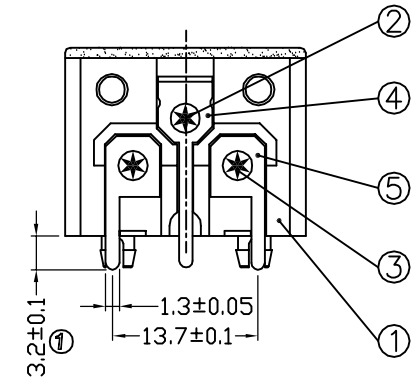
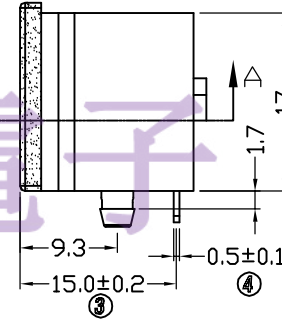
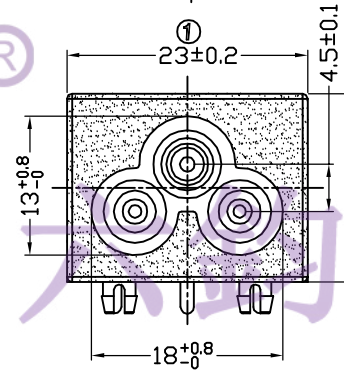
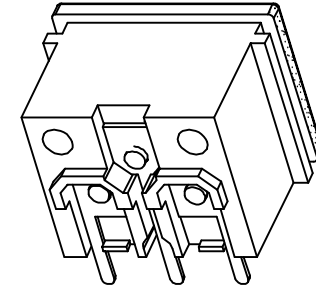
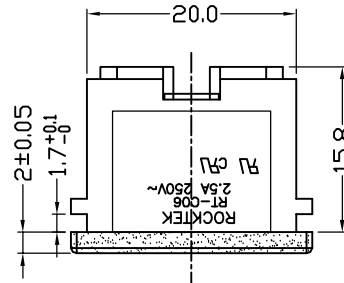
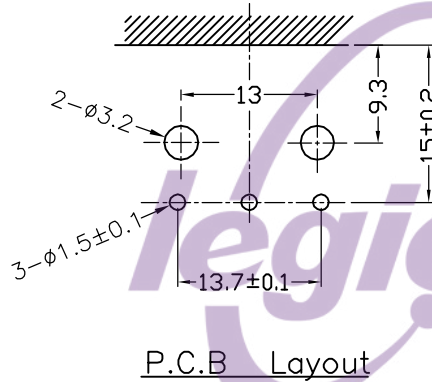

5	2# terminal	C2680 1/2H Tin-plating	2
4	1# terminal	C2680 1/2H Tin-plating	1
3	2# PIN	C3602 Ni-plating	2
2	1# PIN	C3602 Ni-plating	1
1	BODY	PC Black	1
NO.	PART NAME	MATERIAL	Q'TY

5	→	10	→	DIMENSIONAL TOLERANCES		APPROVED	CHECKED	DESIGN	DRAWN	ALL SIZE ARE IN	MM		
4	→	9	→	RANGE	TOLERANCE				LMC	SCALE	NO		
3	→	8	→	X	±0.30				2020.11.14	MAT'L	***		
2	→	7	→	X.X	±0.20					MATERIAL NO.	DRAWING NO.		REV.
1	→	6	→	X.XX	±0.10					RT-C06-A1B-CC	WIF122004		AO
NO	DESCRIPTION	NO	DESCRIPTION	ANGLES	±1'	LEGIION ELECTRONIC & HARDWARE CO., LTD.							