

APPROVED: _____
 DATE: _____ TITLE: _____

Rev	AWO #	Description	Date	Appr
-		RELEASED	9/22/21	

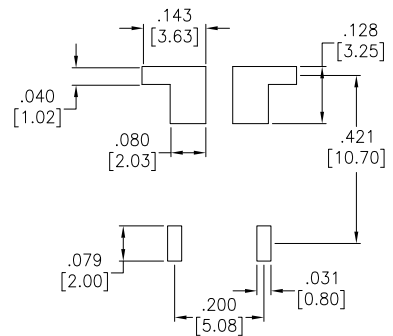

RECOMMENDED PCB LAYOUT

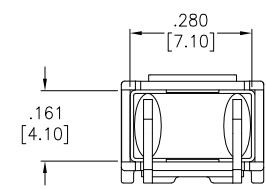
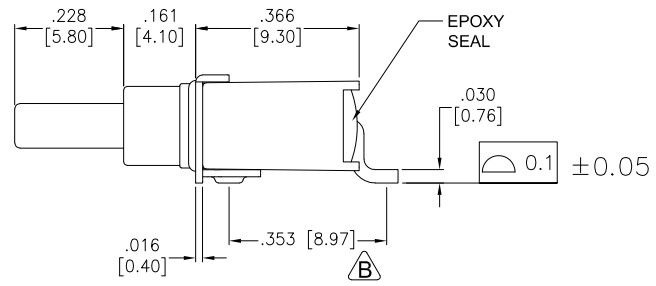
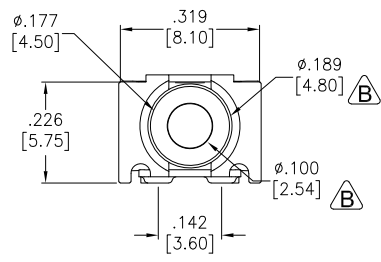
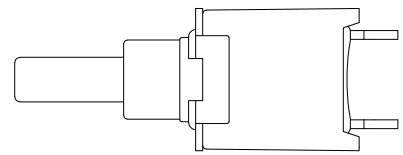
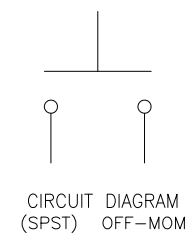
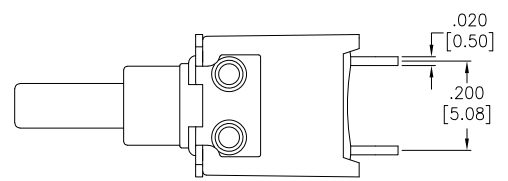

BUTTON POSITION		
FUNCTION	OFF	MOM

SPECIFICATIONS:
 Material:
 Case: PA9T, Rated UL94V-0
 Plunger: FR52, Rated UL94V-0
 Bushing: PA9T, Rated UL94V-0
 Movable Contact: Copper Alloy, Gold over Nickel under plate.
 Terminal: Copper Alloy, Gold over Nickel under plate.
 Electrical:
 Rating: 0.4A max @ 20V AC or DC
 Contact resistance: 20 mΩ max
 Insulation resistance: 1,000 Mohms min
 Dielectric withstanding voltage: 1,500V RMS @Sea level
 Life: 30,000 cycles at full load
 Temperature Rating:
 Operating temperature: -30°C to +85°C
 Environmental:
 Sealed IP67 Rated
 Lead free, RoHS compliant



UNLESS OTHERWISE SPECIFIED ALL DIMENSIONS ARE INCHES [MM]. TOLERANCES: EXCEPT AS NOTED

INCHES	Holes
.X ± .10	ØX ± .10
.XX ± .020	ØXX ± .015
.XXX ± .015	ØXXX ± .010

ADAM TECH
 909 Rahway Avenue,
 Union, NJ 07083
 Phone: 908-687-5000
 Fax: 908-687-5710

DRAWN	WX	9/22/21
CHECKED	RC	9/22/21
APPROVED		
THIS DRAWING CONTAINS INFORMATION THAT IS PROPRIETARY AND SHOULD NOT BE USED WITHOUT PRIOR WRITTEN PERMISSION FROM ADAM TECH		

TITLE SEALED SUB-MINIATURE PUSH BUTTON SWITCH, SPST, OFF-MOM, GOLD PLATED, R/A, SMT		
SIZE X	PART NO. SW-PB9-BBA2RE-7	REV. -
REF:	SCALE: NTS	SHEET 1 OF 1

6 5 4 3 2 1

6 5 4 3 2 1

D

D

C

C

B

B

A

A