



## Description

The IRF9333PBF uses advanced trench technology to provide excellent  $R_{DS(ON)}$ , low gate charge and operation with gate voltages as low as 2.5V. This device is suitable for use as a Battery protection or in other Switching application.



SOP-8

## General Features

$V_{DS} = -30V$   $I_D = -11A$

$R_{DS(ON)} < 16m\Omega$  @  $V_{GS}=10V$

## Application

Battery protection

Load switch

Uninterruptible power supply

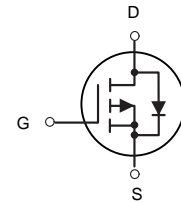

P-Channel MOSFET

## Package Marking and Ordering Information

Product ID	Pack	Brand	Qty(PCS)
IRF9333PBF	SOP-8	HXY MOSFET	3000

## Absolute Maximum Ratings (Tc=25°C unless otherwise noted )

Symbol	Parameter	Rating	Units
$V_{DS}$	Drain-Source Voltage	-30	V
$V_{GS}$	Gate-Source Voltage	$\pm 20$	V
$I_D @ T_A=25^\circ C$	Drain Current <sup>3</sup> , $V_{GS}$ @ 10V	-11	A
$I_D @ T_A=70^\circ C$	Drain Current <sup>3</sup> , $V_{GS}$ @ 10V	-9.1	A
$I_{DM}$	Pulsed Drain Current <sup>1</sup>	-40	A
$P_D @ T_A=25^\circ C$	Total Power Dissipation	2.5	W
$T_{STG}$	Storage Temperature Range	-55 to 150	°C
$T_J$	Operating Junction Temperature Range	-55 to 150	°C
$R_{thj-a}$	Maximum Thermal Resistance, Junction-ambient <sup>3</sup>	50	°C/W



### Electrical Characteristics@T<sub>j</sub>=25°C(unless otherwise specified)

Symbol	Parameter	Test Conditions	Min.	Typ.	Max.	Units
BV <sub>DSS</sub>	Drain-Source Breakdown Voltage	V <sub>GS</sub> =0V, I <sub>D</sub> =-250uA	-30	-	-	V
R <sub>DS(ON)</sub>	Static Drain-Source On-Resistance <sup>2</sup>	V <sub>GS</sub> =-10V, I <sub>D</sub> =-10A	-	12.5	16	mΩ
		V <sub>GS</sub> =-4.5V, I <sub>D</sub> =-6A	-	17	21	mΩ
V <sub>GS(th)</sub>	Gate Threshold Voltage	V <sub>DS</sub> =V <sub>GS</sub> , I <sub>D</sub> =-250uA	-1	-	-3	V
g <sub>fs</sub>	Forward Transconductance	V <sub>DS</sub> =-10V, I <sub>D</sub> =-10A	-	22	-	S
I <sub>DSS</sub>	Drain-Source Leakage Current	V <sub>DS</sub> =-24V, V <sub>GS</sub> =0V	-	-	-10	uA
I <sub>GSS</sub>	Gate-Source Leakage	V <sub>GS</sub> =+20V, V <sub>DS</sub> =0V	-	-	+100	nA
Q <sub>g</sub>	Total Gate Charge	I <sub>D</sub> =-6A	-	28	45	nC
Q <sub>gs</sub>	Gate-Source Charge	V <sub>DS</sub> =-15V	-	7	-	nC
Q <sub>gd</sub>	Gate-Drain ("Miller") Charge	V <sub>GS</sub> =-4.5V	-	11	-	nC
t <sub>d(on)</sub>	Turn-on Delay Time	V <sub>DS</sub> =-15V	-	13	-	ns
t <sub>r</sub>	Rise Time	I <sub>D</sub> =-1A	-	10	-	ns
t <sub>d(off)</sub>	Turn-off Delay Time	R <sub>G</sub> =3.3Ω	-	80	-	ns
t <sub>f</sub>	Fall Time	V <sub>GS</sub> =-10V	-	37	-	ns
C <sub>iss</sub>	Input Capacitance	V <sub>GS</sub> =0V V <sub>DS</sub> =-	-	2940	4700	pF
C <sub>oss</sub>	Output Capacitance	15V f=1.0MHz	-	290	-	pF
C <sub>rss</sub>	Reverse Transfer Capacitance		-	210	-	pF
R <sub>g</sub>	Gate Resistance	f=1.0MHz	-	6.2	12.4	Ω
V <sub>SD</sub>	Forward On Voltage <sup>2</sup>	I <sub>S</sub> =-2.1A, V <sub>GS</sub> =0V	-	-	-1.2	V
t <sub>rr</sub>	Reverse Recovery Time	I <sub>S</sub> =-10A, V <sub>GS</sub> =0V, dI/dt=100A/μs	-	19	-	ns
Q <sub>rr</sub>	Reverse Recovery Charge		-	6	-	nC

Notes:

- 1.Pulse width limited by Max. junction temperature.
- 2.Pulse test
- 3.Surface mounted on 1 in<sup>2</sup> copper pad of FR4 board, t ≤ 10s ; 125 °C/W when mounted on Min. copper pad.



## Typical Electrical

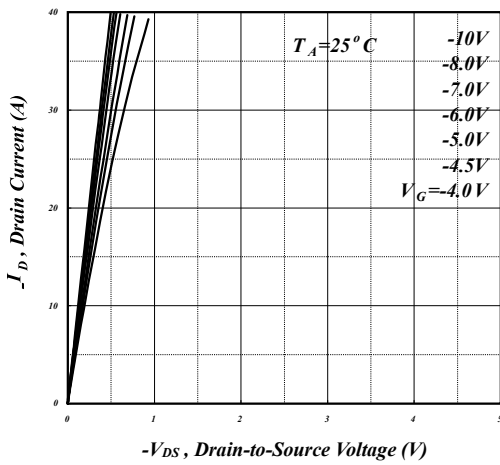

Fig 1. Typical Output Characteristics

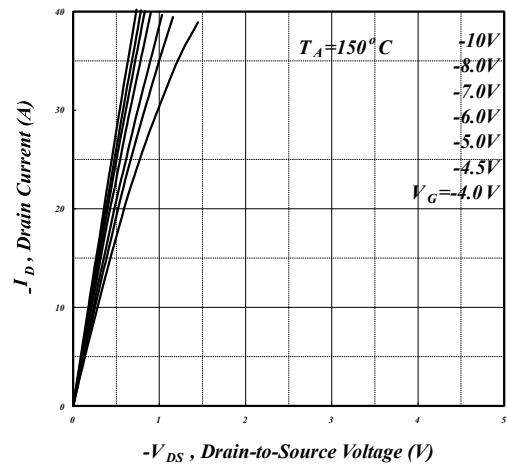

Fig 2. Typical Output Characteristics

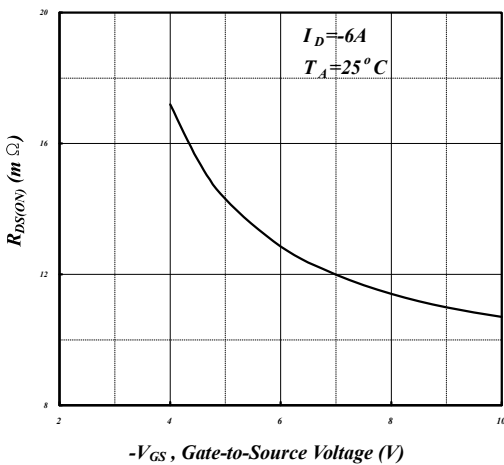

Fig 3. On-Resistance v.s. Gate Voltage

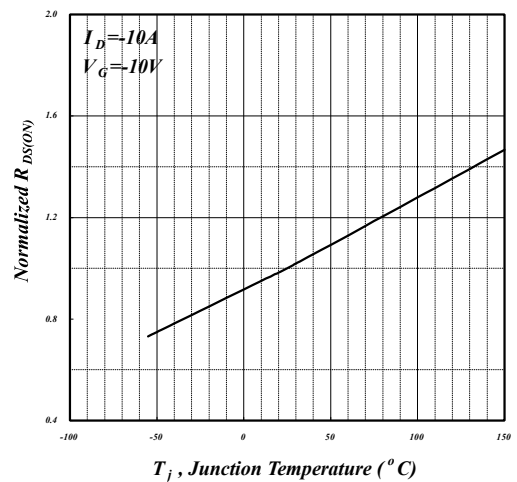
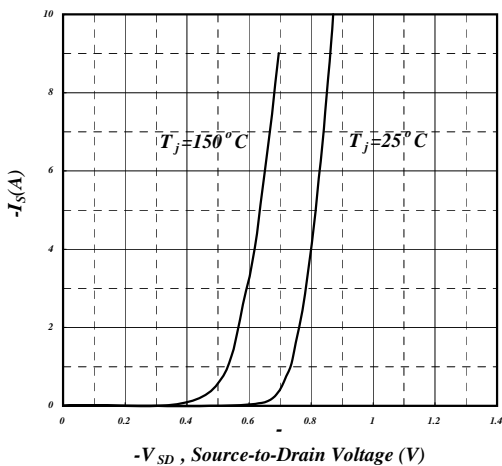

Fig 4. Normalized On-Resistance v.s. Junction Temperature



Reverse Diode

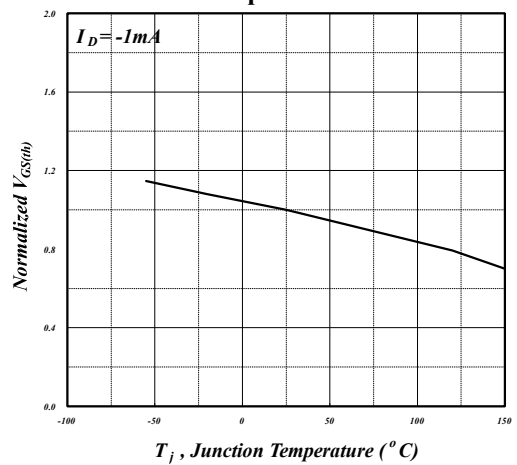

Fig 6. Gate Threshold Voltage v.s. Junction Temperature

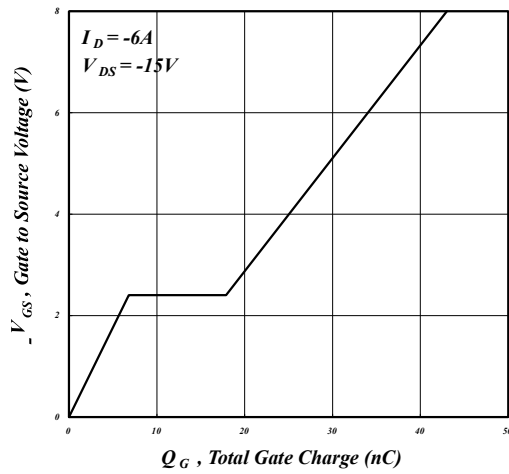

Fig 7. Gate Charge Characteristics

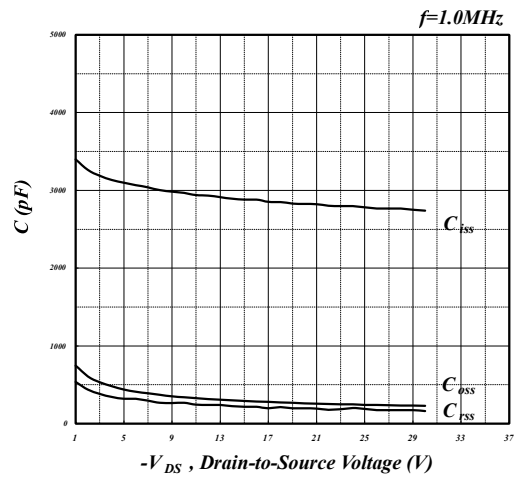

Fig 8. Typical Capacitance Characteristics

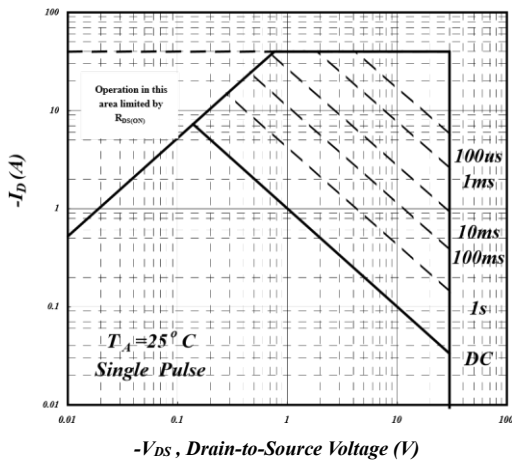

Fig 9. Maximum Safe Operating Area

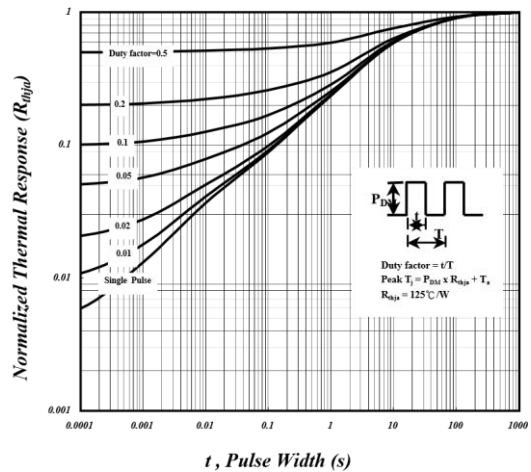

Fig 10. Effective Transient Thermal Impedance

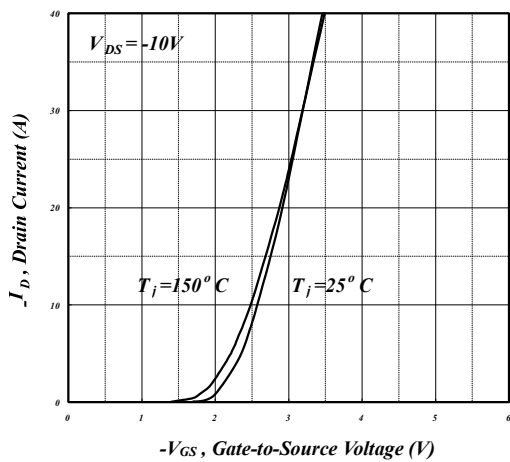

Fig 11. Transfer Characteristics

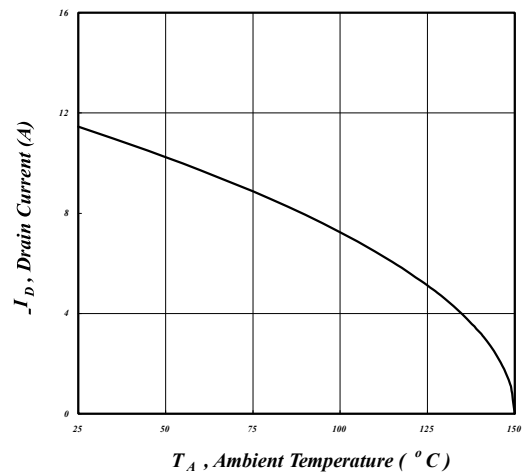

Fig 12. Drain Current v.s. Ambient Temperature

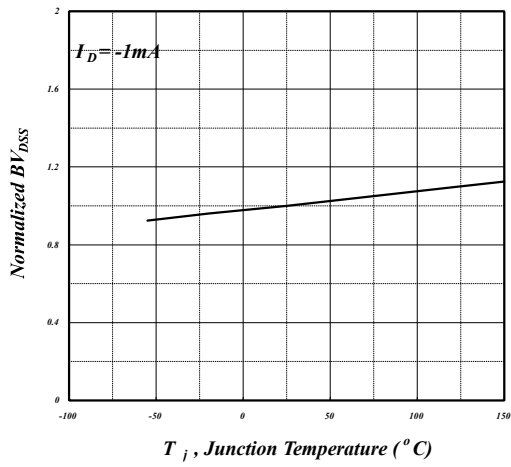

Fig 13. Normalized  $BV_{DSS}$  v.s. Junction Temperature

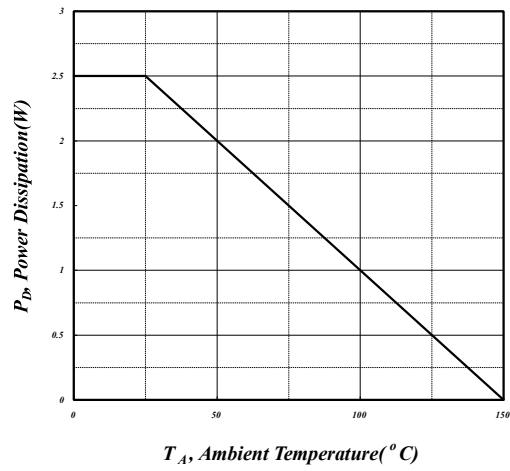

Fig 14. Total Power Dissipation

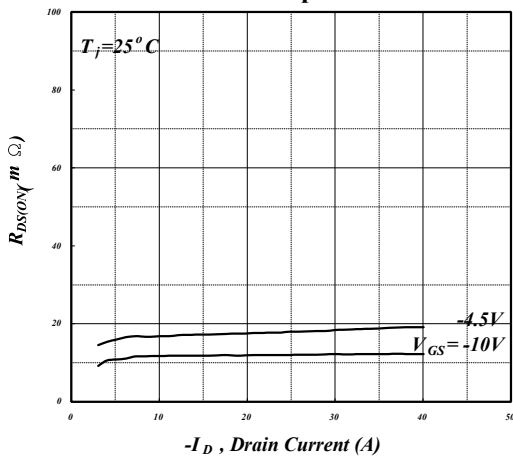
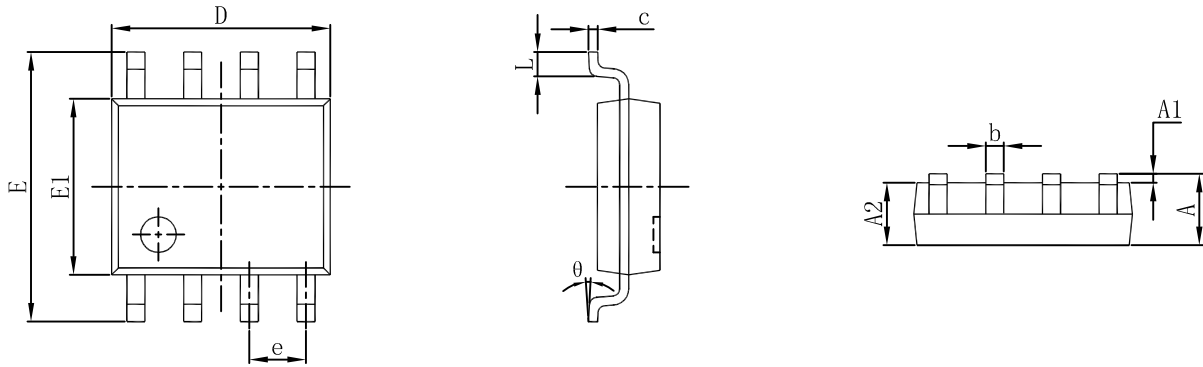

Fig 15. Typ. Drain-Source on State Resistance



### SOP-8 Package Outline Dimensions



Symbol	Dimensions In Millimeters		Dimensions In Inches	
	Min	Max	Min	Max
A	1.350	1.750	0.053	0.069
A1	0.100	0.250	0.004	0.010
A2	1.350	1.550	0.053	0.061
b	0.330	0.510	0.013	0.020
c	0.170	0.250	0.007	0.010
D	4.800	5.000	0.189	0.197
e	1.270 (BSC)		0.050 (BSC)	
E	5.800	6.200	0.228	0.244
E1	3.800	4.000	0.150	0.157
L	0.400	1.270	0.016	0.050
θ	0°	8°	0°	8°

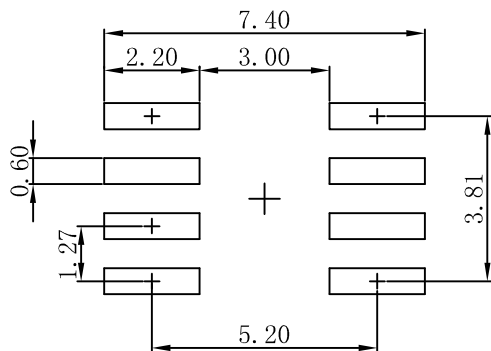

Note:  
 1. Controlling dimension: in millimeters.  
 2. General tolerance:  $\pm 0.05\text{mm}$ .  
 3. The pad layout is for reference purposes only.



### Attention

- Any and all HUA XUAN YANG ELECTRONICS products described or contained herein do not have specifications that can handle applications that require extremely high levels of reliability, such as life-support systems, aircraft's control systems, or other applications whose failure can be reasonably expected to result in serious physical and/or material damage. Consult with your HUA XUAN YANG ELECTRONICS representative nearest you before using any HUA XUAN YANG ELECTRONICS products described or contained herein in such applications.
- HUA XUAN YANG ELECTRONICS assumes no responsibility for equipment failures that result from using products at values that exceed, even momentarily, rated values (such as maximum ratings, operating condition ranges, or other parameters) listed in products specifications of any and all HUA XUAN YANG ELECTRONICS products described or contained herein.
- Specifications of any and all HUA XUAN YANG ELECTRONICS products described or contained herein stipulate the performance, characteristics, and functions of the described products in the independent state, and are not guarantees of the performance, characteristics, and functions of the described products as mounted in the customer's products or equipment. To verify symptoms and states that cannot be evaluated in an independent device, the customer should always evaluate and test devices mounted in the customer's products or equipment.
- HUA XUAN YANG ELECTRONICS CO.,LTD. strives to supply high-quality high-reliability products. However, any and all semiconductor products fail with some probability. It is possible that these probabilistic failures could give rise to accidents or events that could endanger human lives, that could give rise to smoke or fire, or that could cause damage to other property. When designing equipment, adopt safety measures so that these kinds of accidents or events cannot occur. Such measures include but are not limited to protective circuits and error prevention circuits for safe design, redundant design, and structural design.
- In the event that any or all HUA XUAN YANG ELECTRONICS products(including technical data, services) described or contained herein are controlled under any of applicable local export control laws and regulations, such products must not be exported without obtaining the export license from the authorities concerned in accordance with the above law.
- No part of this publication may be reproduced or transmitted in any form or by any means, electronic or mechanical, including photocopying and recording, or any information storage or retrieval system, or otherwise, without the prior written permission of HUA XUAN YANG ELECTRONICS CO.,LTD.
- Information (including circuit diagrams and circuit parameters) herein is for example only ; it is not guaranteed for volume production. HUA XUAN YANG ELECTRONICS believes information herein is accurate and reliable, but no guarantees are made or implied regarding its use or any infringements of intellectual property rights or other rights of third parties.
- Any and all information described or contained herein are subject to change without notice due to product/technology improvement, etc. When designing equipment, refer to the "Delivery Specification" for the HUA XUAN YANG ELECTRONICS product that you intend to use.