

01 Pin

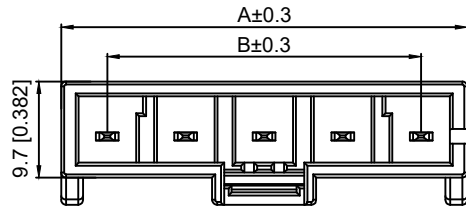

02~05 Pin

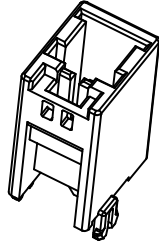
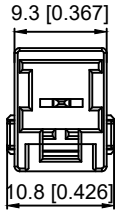
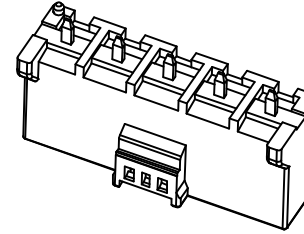

Specifications:

规格:

Voltage rating:600V AC/DC  
 额定电压: 600V AC/DC  
 Withstanding voltage:2500V AC/minute  
 耐受电压: 2500V AC/分钟  
 Temperature range:-40°C~+125°C  
 温度范围: -40°C~+125°C  
 Insulation resistance:1000MΩ min  
 绝缘电阻: 1000MΩ Min  
 Contact resistance:5mΩ Max  
 接触电阻: 5mΩ Max

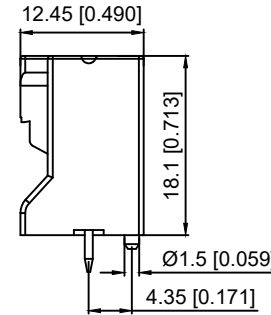
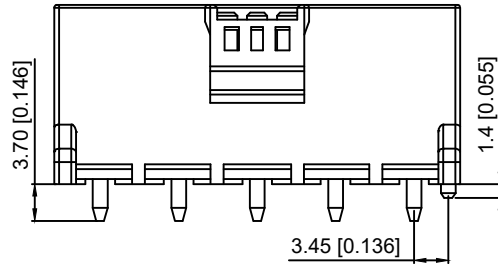
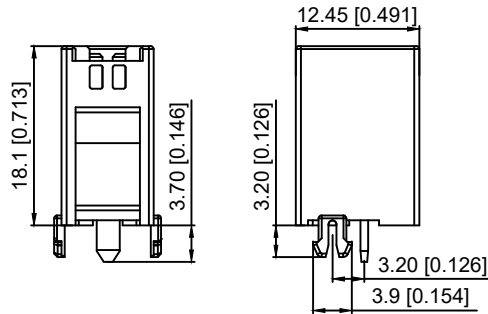

K 792100 W V - XX S - N0 XX X  
 ① ② ③ ④ ⑤ ⑥ ⑦ ⑧ ⑨

- 1.K: XKBTEK-Car Connector
- 2.XKB Series No
- 3.Category:W-Wafer
- 4.Welding Board Angle:V-Stright 180°
- 5.Row No.Pin No:XX-01~05 Pin
- 6.Special No:S-With Positioning column
- 7.Material:N0-PA66+30%GF 94V-0
- 8.Plating:SN-Plated Tin or V01-Gole 1u"
- 9.Color:B-Black ;R-Red;Blank-Natural

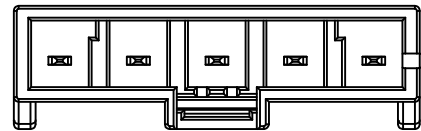

Guide Key : Inside Color : Natural

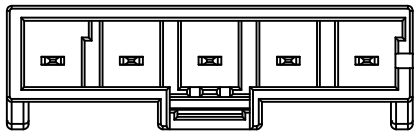

Guide Key : Left Side Color : Red

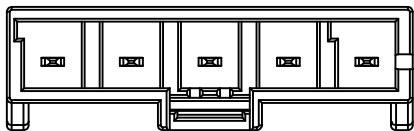

Guide Key : Right Side Color : Black

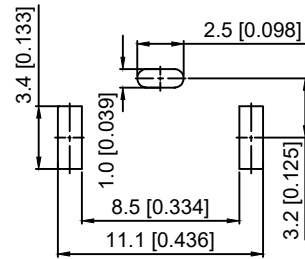
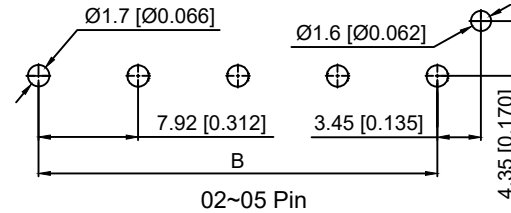
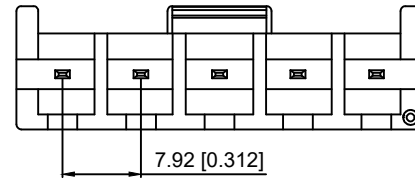

01 Pin

PART NO	DIM A	DIM B
01	/	/
02	17.22	7.92
03	25.14	15.84
04	33.06	23.76
05	40.98	31.68

Poles	10 AWG	12 AWG	14 AWG	16 AWG
1	30 A	25 A	20 A	15 A
2	25 A	20 A	18 A	15 A
3	25 A	20 A	18 A	15 A
4	22 A	18 A	15 A	13 A
5	22 A	18 A	15 A	13 A

PART NO	Material	Material(Pin)	Suitable XKB Housing
K792100WV-XXS-N0XXX	PA66	Phosphor Bronze	K792100H

DSND	SCALE: N/A	MODEL TYPE:
DWN	VIEW:	7.92mm Automobile connector
CHKD	UNIT: mm/in	PART NO.: K792100WV-XXS-N0XXX
APPD	SIZE: A4	DWG NO.: X-K792100WV-XXS-N0XXX



XKB INDUSTRIAL PRECISION CO.,LIMITED

WEIGHT	SHEET	REVISION
	1/1	A0

ANGLAR	±5°
L ≤ 4	±0.2
4 < L ≤ 16	±0.3
16 < L ≤ 63	±0.4
L > 63	±0.5

UNSPECIFIED TOLERANCES

REVISIONS

DESCRIPTION

DATE

REVISED

APPROVED

MARK

Δx  
Δx  
Δx