

UTT150N06-VB Datasheet

N-Channel 60 V (D-S) MOSFET

PRODUCT SUMMARY	
V _{DS} (V)	60
R _{DS(on)} (Ω) at V _{GS} = 10 V	0.0016
R _{DS(on)} (Ω) at V _{GS} = 4.5 V	0.0020
I _D (A)	270
Configuration	Single

FEATURES

- TrenchFET® power MOSFET
- Package with low thermal resistance
- 100 % R_g and UIS tested



RoHS
COMPLIANT
HALOGEN
FREE

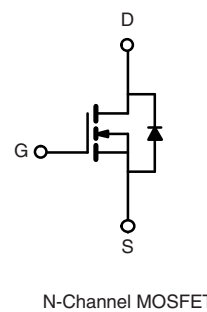
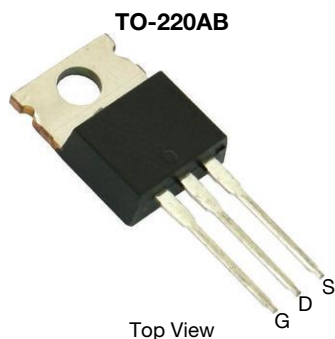

ABSOLUTE MAXIMUM RATINGS (T _C = 25 °C, unless otherwise noted)				
PARAMETER		SYMBOL	LIMIT	UNIT
Drain-Source Voltage		V _{DS}	60	V
Gate-Source Voltage		V _{GS}	± 20	
Continuous Drain Current	T _C = 25 °C	I _D	270	A
	T _C = 125 °C		120 ^a	
Continuous Source Current (Diode Conduction)		I _S	120 ^a	
Pulsed Drain Current ^b		I _{DM}	600	
Single Pulse Avalanche Current	L = 0.1 mH	I _{AS}	75	
Single Pulse Avalanche Energy		E _{AS}	281	
Maximum Power Dissipation ^b	T _C = 25 °C	P _D	375	W
	T _C = 125 °C		125	
Operating Junction and Storage Temperature Range		T _J , T _{stg}	-55 to +175	°C

THERMAL RESISTANCE RATINGS				
PARAMETER		SYMBOL	LIMIT	UNIT
Junction-to-Ambient	PCB Mount ^c	R _{thJA}	40	°C/W
Junction-to-Case (Drain)		R _{thJC}	0.4	

Notes

- Package limited.
- Pulse test; pulse width ≤ 300 μs, duty cycle ≤ 2 %.
- When mounted on 1" square PCB (FR4 material).

SPECIFICATIONS (T _C = 25 °C, unless otherwise noted)						
PARAMETER	SYMBOL	TEST CONDITIONS	MIN.	TYP.	MAX.	UNIT
Static						
Drain-Source Breakdown Voltage	V _{DS}	V _{GS} = 0 V, I _D = 250 μA	60	-	-	V
Gate-Source Threshold Voltage	V _{GS(th)}	V _{DS} = V _{GS} , I _D = 250 μA	1.5	2.0	2.5	
Gate-Source Leakage	I _{GSS}	V _{DS} = 0 V, V _{GS} = ± 20 V	-	-	± 100	nA
Zero Gate Voltage Drain Current	I _{DSS}	V _{GS} = 0 V, V _{DS} = 60 V	-	-	1	μA
		V _{GS} = 0 V, V _{DS} = 60 V, T _J = 125 °C	-	-	50	
		V _{GS} = 0 V, V _{DS} = 60 V, T _J = 175 °C	-	-	1.5	mA
On-State Drain Current ^a	I _{D(on)}	V _{GS} = 10 V, V _{DS} ≥ 5 V	120	-	-	A
Drain-Source On-State Resistance ^a	R _{DS(on)}	V _{GS} = 10 V, I _D = 30 A	-	0.0016	-	Ω
		V _{GS} = 10 V, I _D = 30 A, T _J = 125 °C	-	0.0031	-	
		V _{GS} = 10 V, I _D = 30 A, T _J = 175 °C	-	0.0037	-	
		V _{GS} = 4.5 V, I _D = 20 A	-	0.0020	-	
Forward Transconductance ^b	g _{fs}	V _{DS} = 15 V, I _D = 30 A	-	164	-	S
Dynamic ^b						
Input Capacitance	C _{iss}	V _{GS} = 0 V, V _{DS} = 25 V, f = 1 MHz	-	12 060	15 100	pF
Output Capacitance	C _{oss}		-	5750	7200	
Reverse Transfer Capacitance	C _{rss}		-	860	1100	
Total Gate Charge ^c	Q _g	V _{GS} = 10 V, V _{DS} = 30 V, I _D = 80 A	-	128	200	nC
Gate-Source Charge ^c	Q _{gs}		-	33	-	
Gate-Drain Charge ^c	Q _{gd}		-	11	-	
Gate Resistance	R _g	f = 1 MHz	0.8	1.68	2.6	Ω
Turn-On Delay Time ^c	t _{d(on)}	V _{DD} = 30 V, R _L = 0.375 Ω I _D ≅ 80 A, V _{GEN} = 10 V, R _g = 1 Ω	-	20	25	ns
Rise Time ^c	t _r		-	15	40	
Turn-Off Delay Time ^c	t _{d(off)}		-	65	100	
Fall Time ^c	t _f		-	12	20	
Source-Drain Diode Ratings and Characteristics ^b						
Pulsed Current ^a	I _{SM}		-	-	300	A
Forward Voltage	V _{SD}	I _F = 80 A, V _{GS} = 0 V	-	0.88	1.5	V

Notes

- a. Pulse test; pulse width ≤ 300 μs, duty cycle ≤ 2 %.
- b. Guaranteed by design, not subject to production testing.
- c. Independent of operating temperature.

TYPICAL CHARACTERISTICS ($T_A = 25\text{ }^\circ\text{C}$, unless otherwise noted)

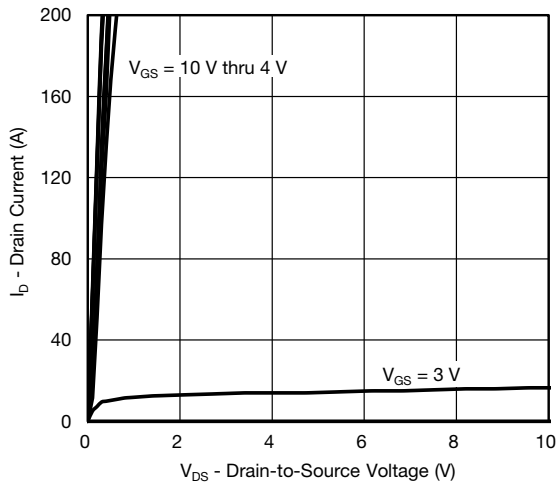

Output Characteristics

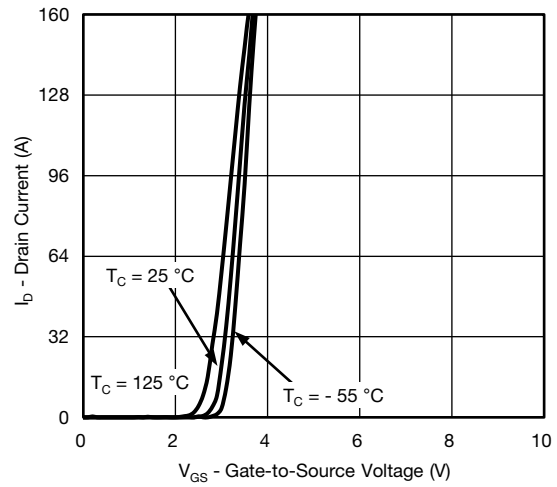

Transfer Characteristics

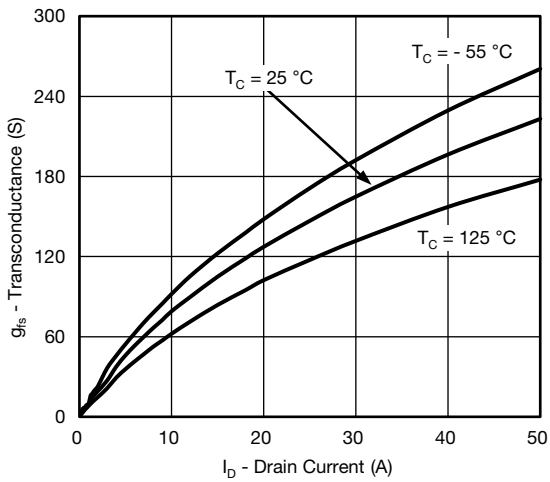

Transconductance

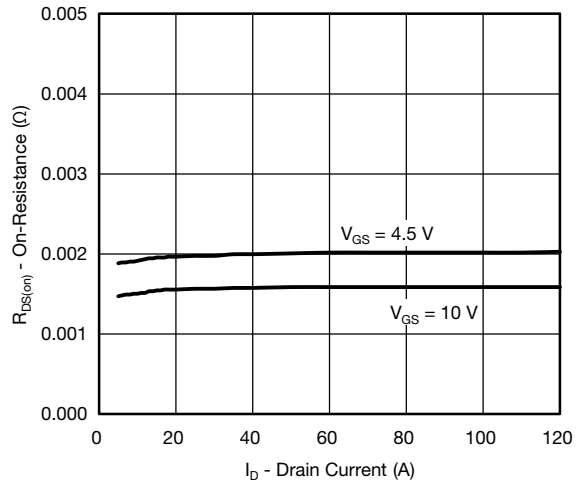

On-Resistance vs. Drain Current

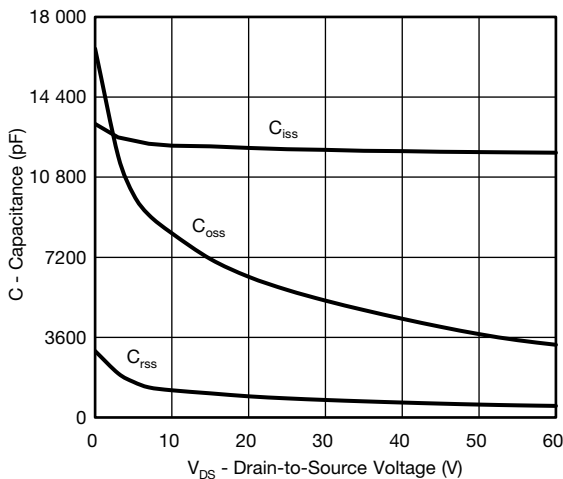

Capacitance

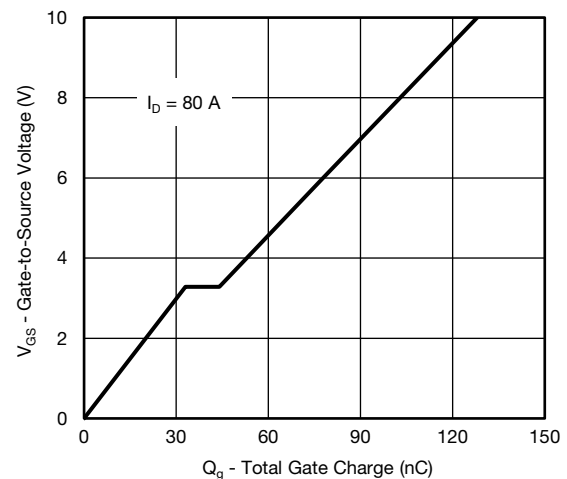

Gate Charge

TYPICAL CHARACTERISTICS ($T_A = 25\text{ }^\circ\text{C}$, unless otherwise noted)

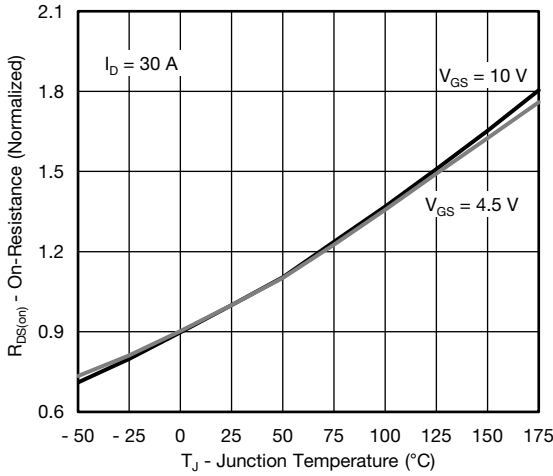

On-Resistance vs. Junction Temperature

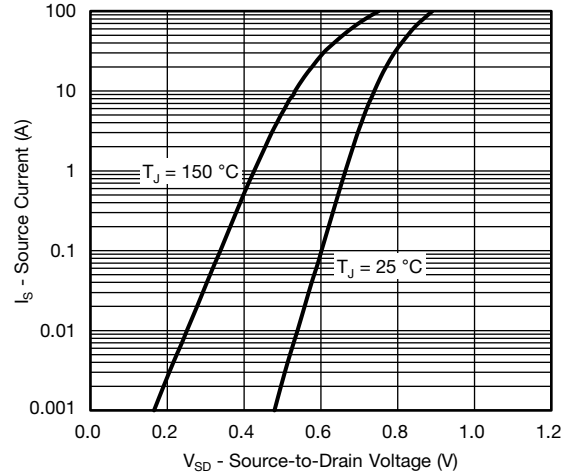

Source Drain Diode Forward Voltage

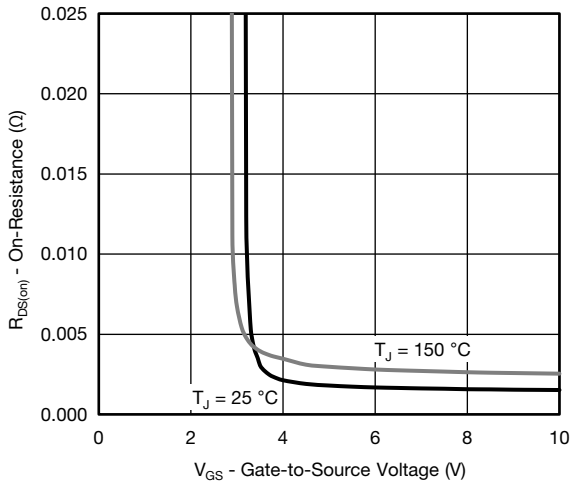

On-Resistance vs. Gate-to-Source Voltage

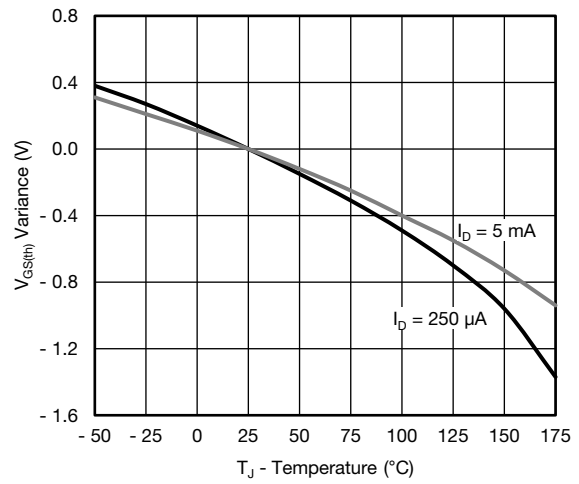

Threshold Voltage

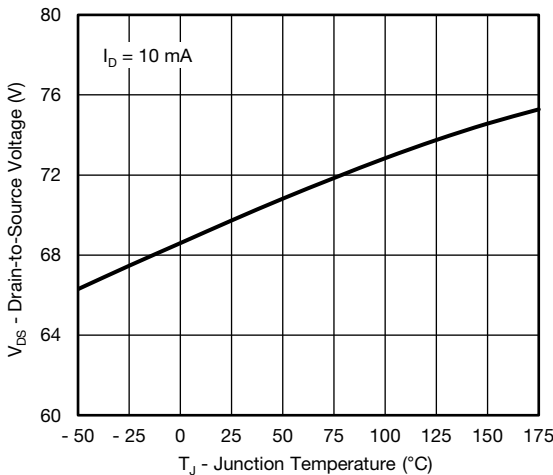

Drain Source Breakdown vs. Junction Temperature

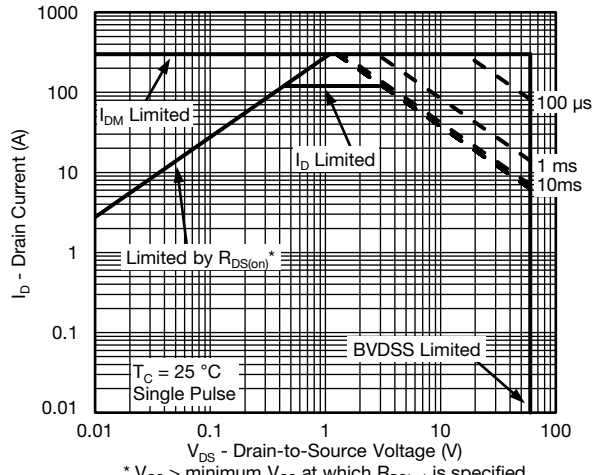

Safe Operating Area

THERMAL RATINGS ($T_A = 25\text{ }^\circ\text{C}$, unless otherwise noted)

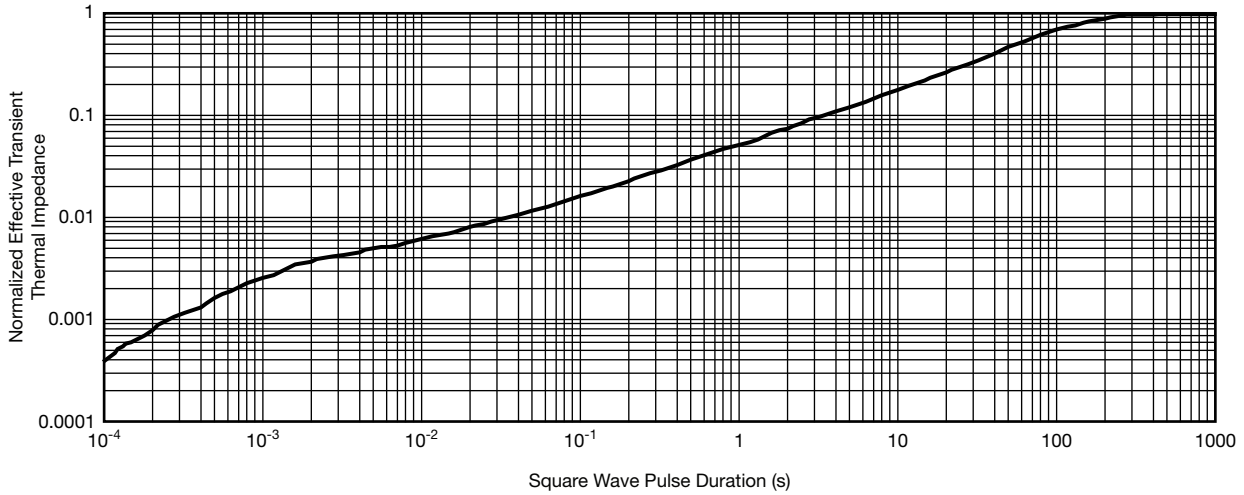

Normalized Thermal Transient Impedance, Junction-to-Ambient

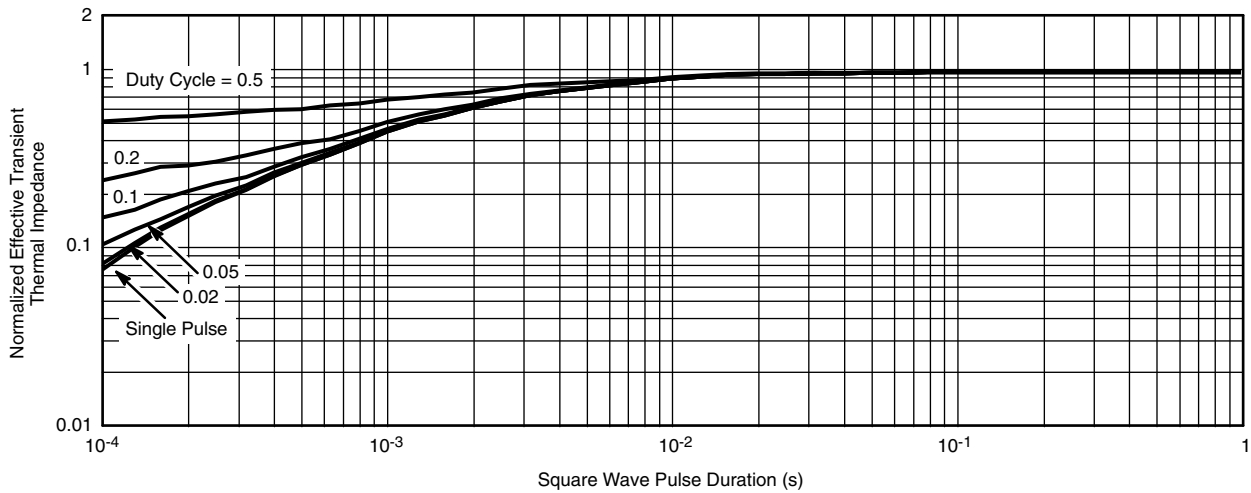

Normalized Thermal Transient Impedance, Junction-to-Case

Note

- The characteristics shown in the two graphs
 - Normalized Transient Thermal Impedance Junction-to-Ambient (25 °C)
 - Normalized Transient Thermal Impedance Junction-to-Case (25 °C)
 are given for general guidelines only to enable the user to get a “ball park” indication of part capabilities. The data are extracted from single pulse transient thermal impedance characteristics which are developed from empirical measurements. The latter is valid for the part mounted on printed circuit board - FR4, size 1" x 1" x 0.062", double sided with 2 oz. copper, 100 % on both sides. The part capabilities can widely vary depending on actual application parameters and operating conditions.

TO-220AB

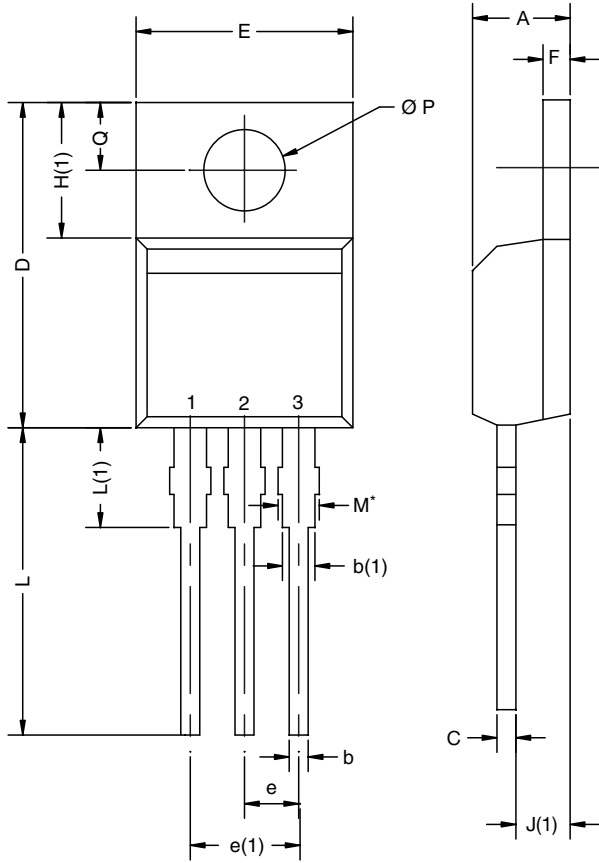

DIM.	INCHES		MILLIMETERS		
	MIN.	MAX.	MIN.	MAX.	
A	0.160	0.190	4.064	4.826	
b	0.020	0.039	0.508	0.990	
b1	0.020	0.035	0.508	0.889	
b2	0.045	0.055	1.143	1.397	
c*	Thin lead	0.013	0.018	0.330	0.457
	Thick lead	0.023	0.028	0.584	0.711
c1	Thin lead	0.013	0.017	0.330	0.431
	Thick lead	0.023	0.027	0.584	0.685
c2	0.045	0.055	1.143	1.397	
D	0.340	0.380	8.636	9.652	
D1	0.220	0.240	5.588	6.096	
D2	0.038	0.042	0.965	1.067	
D3	0.045	0.055	1.143	1.397	
D4	0.044	0.052	1.118	1.321	
E	0.380	0.410	9.652	10.414	
E1	0.245	-	6.223	-	
E2	0.355	0.375	9.017	9.525	
E3	0.072	0.078	1.829	1.981	
e	0.100 BSC		2.54 BSC		
K	0.045	0.055	1.143	1.397	
L	0.575	0.625	14.605	15.875	
L1	0.090	0.110	2.286	2.794	
L2	0.040	0.055	1.016	1.397	
L3	0.050	0.070	1.270	1.778	
L4	0.010 BSC		0.254 BSC		
M	-	0.002	-	0.050	

ECN: T13-0707-Rev. K, 30-Sep-13
DWG: 5843

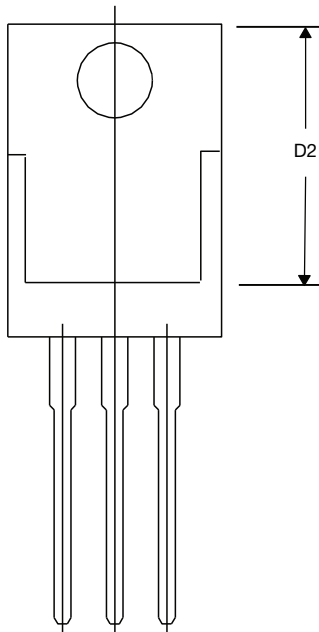

Notes

- Plane B includes maximum features of heat sink tab and plastic.
- No more than 25 % of L1 can fall above seating plane by max. 8 mils.
- Pin-to-pin coplanarity max. 4 mils.
- *: Thin lead is for SUB, SYB.
Thick lead is for SUM, SYM, SQM.
- Use inches as the primary measurement.
-  This feature is for thick lead.

Disclaimer

All products due to improve reliability, function or design or for other reasons, product specifications and data are subject to change without notice.

Taiwan VBsemi Electronics Co., Ltd., branches, agents, employees, and all persons acting on its or their representatives (collectively, the "Taiwan VBsemi"), assumes no responsibility for any errors, inaccuracies or incomplete data contained in the table or any other any disclosure of any information related to the product.(www.VBsemi.com)

Taiwan VBsemi makes no guarantee, representation or warranty on the product for any particular purpose of any goods or continuous production. To the maximum extent permitted by applicable law on Taiwan VBsemi relinquished: (1) any application and all liability arising out of or use of any products; (2) any and all liability, including but not limited to special, consequential damages or incidental ; (3) any and all implied warranties, including a particular purpose, non-infringement and merchantability guarantee.

Statement on certain types of applications are based on knowledge of the product is often used in a typical application of the general product VBsemi Taiwan demand that the Taiwan VBsemi of. Statement on whether the product is suitable for a particular application is non-binding. It is the customer's responsibility to verify specific product features in the products described in the specification is appropriate for use in a particular application. Parameter data sheets and technical specifications can be provided may vary depending on the application and performance over time. All operating parameters, including typical parameters must be made by customer's technical experts validated for each customer application. Product specifications do not expand or modify Taiwan VBsemi purchasing terms and conditions, including but not limited to warranty herein.

Unless expressly stated in writing, Taiwan VBsemi products are not intended for use in medical, life saving, or life sustaining applications or any other application. Wherein VBsemi product failure could lead to personal injury or death, use or sale of products used in Taiwan VBsemi such applications using client did not express their own risk. Contact your authorized Taiwan VBsemi people who are related to product design applications and other terms and conditions in writing.

The information provided in this document and the company's products without a license, express or implied, by estoppel or otherwise, to any intellectual property rights granted to the VBsemi act or document. Product names and trademarks referred to herein are trademarks of their respective representatives will be all.

Material Category Policy

Taiwan VBsemi Electronics Co., Ltd., hereby certify that all of the products are determined to be oHS compliant and meets the definition of restrictions under Directive of the European Parliament 2011/65 / EU, 2011 Nian. 6. 8 Ri Yue restrict the use of certain hazardous substances in electrical and electronic equipment (EEE) - modification, unless otherwise specified as inconsistent.(www.VBsemi.com)

Please note that some documents may still refer to Taiwan VBsemi RoHS Directive 2002/95 / EC. We confirm that all products identified as consistent with the Directive 2002/95 / EC European Directive 2011/65 /.

Taiwan VBsemi Electronics Co., Ltd. hereby certify that all of its products comply identified as halogen-free halogen-free standards required by the JEDEC JS709A. Please note that some Taiwanese VBsemi documents still refer to the definition of IEC 61249-2-21, and we are sure that all products conform to confirm compliance with IEC 61249-2-21 standard level JS709A.