

IRF3708S-VB Datasheet

N-Channel 20-V (D-S), 175°C MOSFET



RoHS
COMPLIANT
HALOGEN
FREE

PRODUCT SUMMARY		
$V_{(BR)DSS}$ (V)	$r_{DS(on)}$ (Ω)	I_D (A) ^a
20	0.006 @ $V_{GS} = 4.5$ V	85
	0.009 @ $V_{GS} = 2.5$ V	85

FEATURES

- TrenchFET[®] Power MOSFET
- 100 % R_g and UIS Tested
- Compliant to RoHS Directive 2011/65/EU

APPLICATIONS

- OR-ing
- Server
- DC/DC

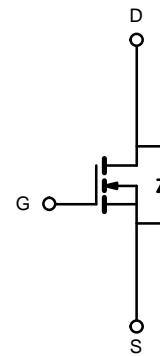

N-Channel MOSFET

ABSOLUTE MAXIMUM RATINGS ($T_C = 25^\circ\text{C}$ UNLESS OTHERWISE NOTED)				
Parameter	Symbol	Limit	Unit	
Drain-Source Voltage	V_{DS}	20	V	
Gate-Source Voltage	V_{GS}	± 12		
Continuous Drain Current ($T_J = 175^\circ\text{C}$)	I_D	$T_C = 25^\circ\text{C}$	85 ^a	A
		$T_C = 100^\circ\text{C}$	75	
Pulsed Drain Current	I_{DM}	240		
Avalanche Current	I_{AR}	30		
Repetitive Avalanche Energy ^b	E_{AR}	45	mJ	
Power Dissipation	P_D	120 ^a	W	
Operating Junction and Storage Temperature Range	T_J, T_{stg}	-55 to 175	$^\circ\text{C}$	

THERMAL RESISTANCE RATINGS				
Parameter	Symbol	Limit	Unit	
Junction-to-Ambient	R_{thJA}	PCB Mount (TO-263) ^c	40	$^\circ\text{C/W}$
		Free Air (TO-220AB)	62.5	
Junction-to-Case	R_{thJC}	1.25		

Notes:

- See SOA curve for voltage derating.
- Duty cycle $\leq 1\%$.
- When mounted on 1" square PCB (FR-4 material).

MOSFET SPECIFICATIONS (T _J = 25 °C UNLESS OTHERWISE NOTED)						
Parameter	Symbol	Test Condition	Min	Typ	Max	Unit
Static						
Drain-Source Breakdown Voltage	V _{(BR)DSS}	V _{GS} = 0 V, I _D = 250 μA	20			V
Gate Threshold Voltage	V _{GS(th)}	V _{DS} = V _{GS} , I _{DS} = 250 μA	0.6			
Gate-Body Leakage	I _{GSS}	V _{DS} = 0 V, V _{GS} = ± 12 V			± 100	nA
Zero Gate Voltage Drain Current	I _{DSS}	V _{DS} = 20 V, V _{GS} = 0 V			1	μA
		V _{DS} = 20 V, V _{GS} = 0 V, T _J = 125 °C			50	
		V _{DS} = 20 V, V _{GS} = 0 V, T _J = 175 °C			150	
On-State Drain Current ^a	I _{D(on)}	V _{DS} = 5 V, V _{GS} = 4.5 V	120			A
Drain-Source On-State Resistance ^a	r _{DS(on)}	V _{GS} = 4.5 V, I _D = 30 A		0.006		Ω
		V _{GS} = 4.5 V, I _D = 30 A, T _J = 125 °C		0.009		
		V _{GS} = 4.5 V, I _D = 30 A, T _J = 175 °C		0.0111		
		V _{GS} = 2.5 V, I _D = 20 A		0.009		
Forward Transconductance ^a	g _{fs}	V _{DS} = 5 V, I _D = 30 A	20			S
Dynamic^b						
Input Capacitance	C _{iss}	V _{GS} = 0 V, V _{DS} = 20 V, f = 1 MHz		6600		pF
Output Capacitance	C _{oss}			1150		
Reversen Transfer Capacitance	C _{riss}			600		
Total Gate Charge ^c	Q _g	V _{DS} = 10 V, V _{GS} = 4.5 V, I _D = 85 A		65	130	nC
Gate-Source Charge ^c	Q _{gs}			13		
Gate-Drain Charge ^c	Q _{gd}			14		
Turn-On Delay Time ^c	t _{d(on)}	V _{DD} = 10 V, R _L = 0.12 Ω I _D = 85 A, V _{GEN} = 4.5 V, R _G = 2.5 Ω		25	40	ns
Rise Time ^c	t _r			120	180	
Turn-Off Delay Time ^c	t _{d(off)}			80	120	
Fall Time ^c	t _f			100	150	
Source-Drain Diode Ratings and Characteristics (T_C = 25 °C)^b						
Pulsed Current	I _{SM}				240	A
Forward Voltage ^a	V _{SD}	I _F = 100 A, V _{GS} = 0 V		1.2	1.5	V
Reverse Recovery Time	t _{rr}	I _F = 50 A, di/dt = 100 A/μs		45	100	ns

Notes:

- a. Pulse test; pulse width ≤ 300 μs, duty cycle ≤ 2%.
- b. Guaranteed by design, not subject to production testing.
- c. Independent of operating temperature.

TYPICAL CHARACTERISTICS (25°C UNLESS NOTED)

Output Characteristics

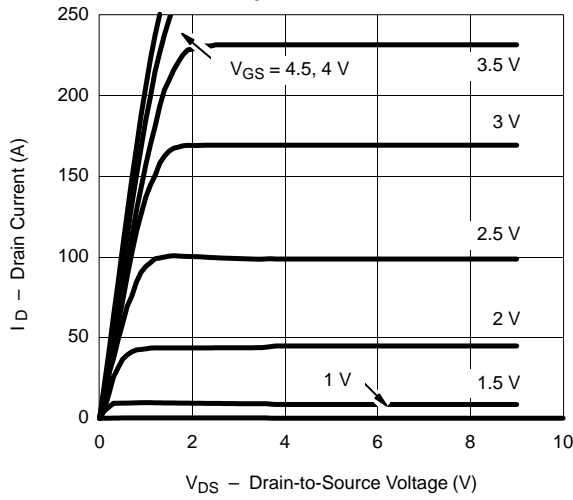

Transfer Characteristics

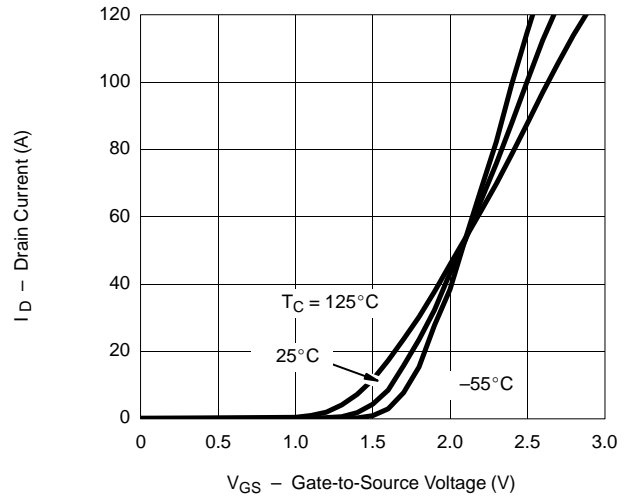

Transconductance

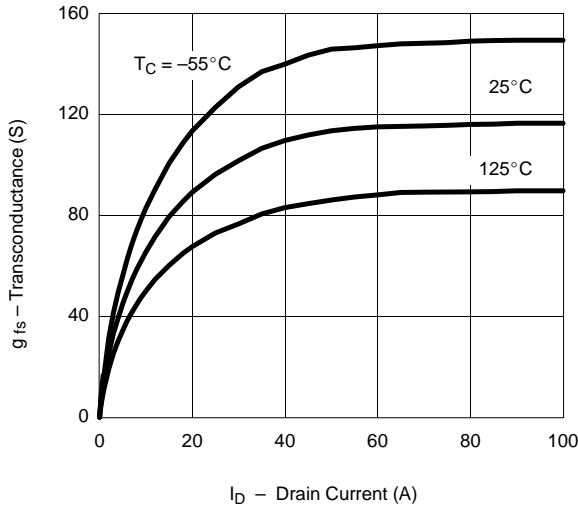

On-Resistance vs. Drain Current

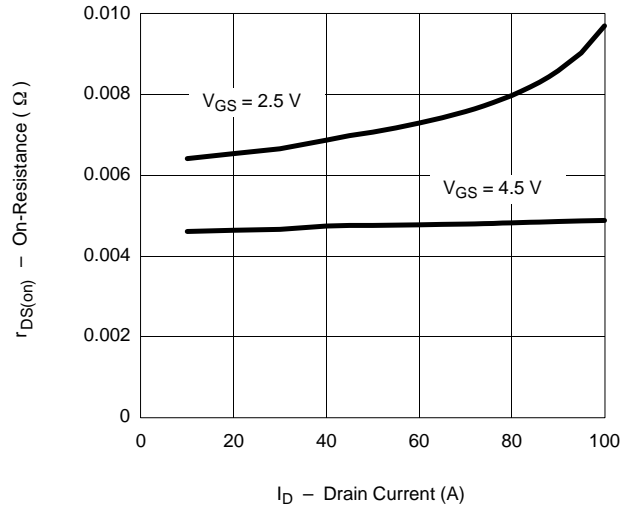

Capacitance

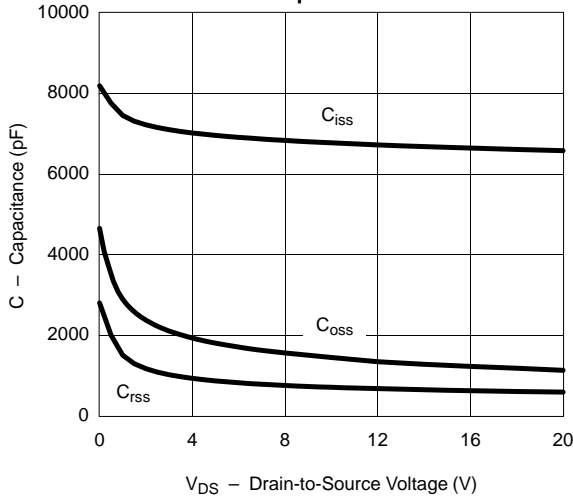

Gate Charge

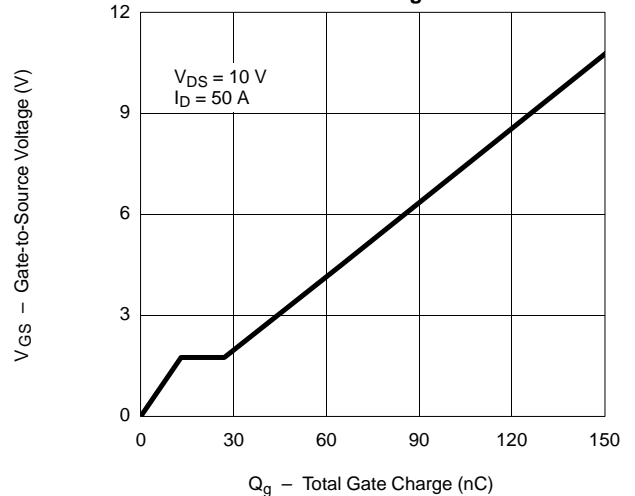

TYPICAL CHARACTERISTICS (25°C UNLESS NOTED)

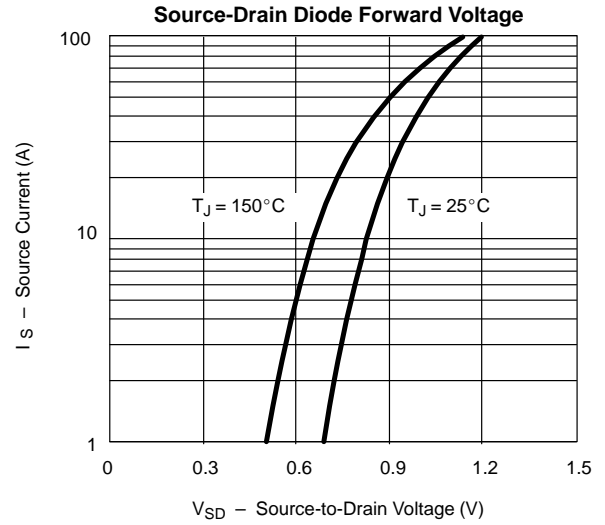
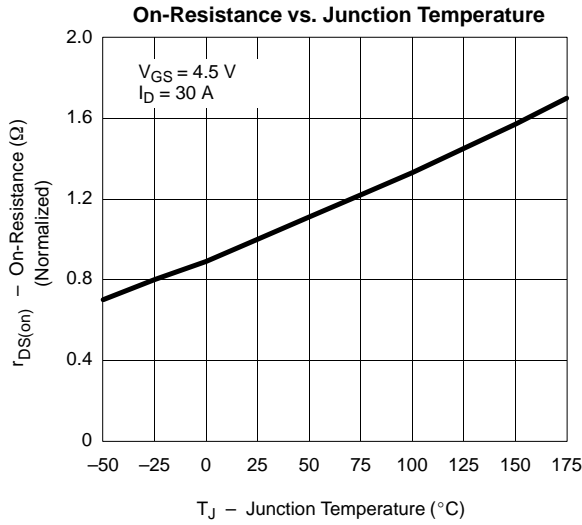

THERMAL RATINGS

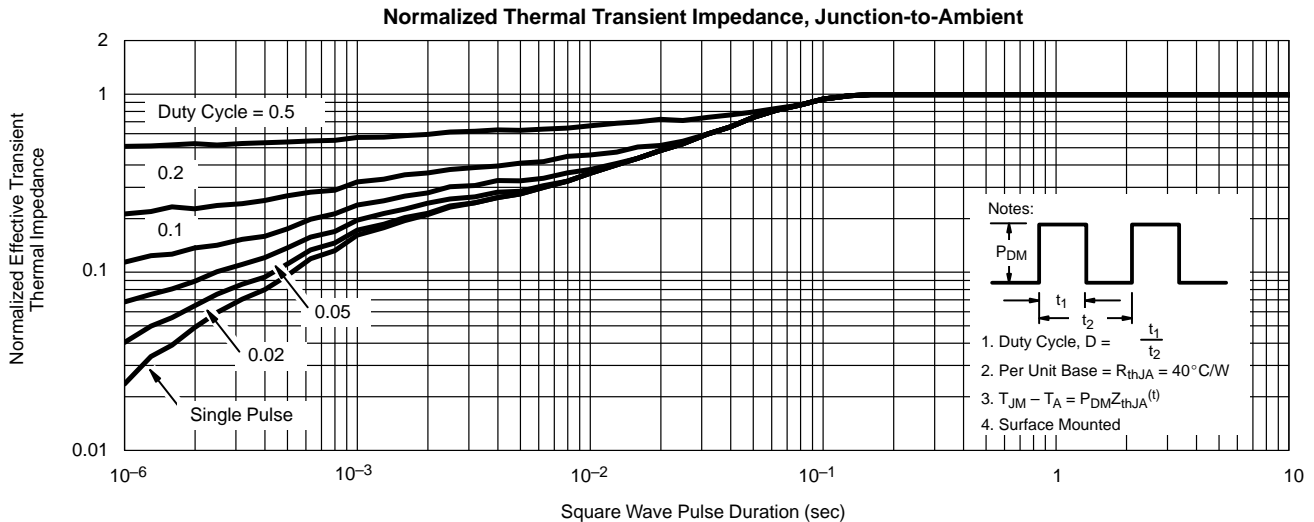
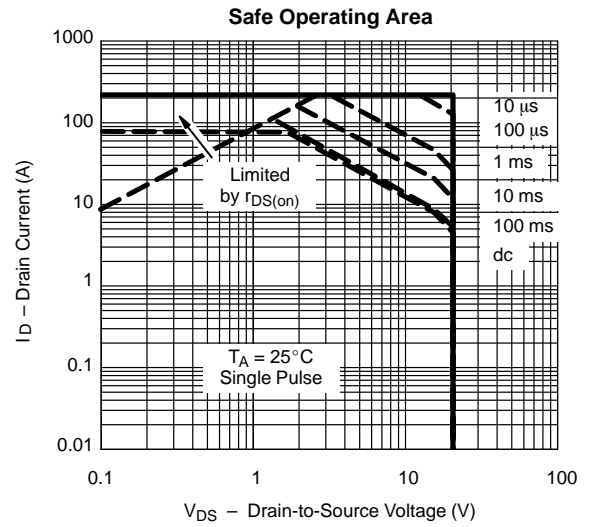
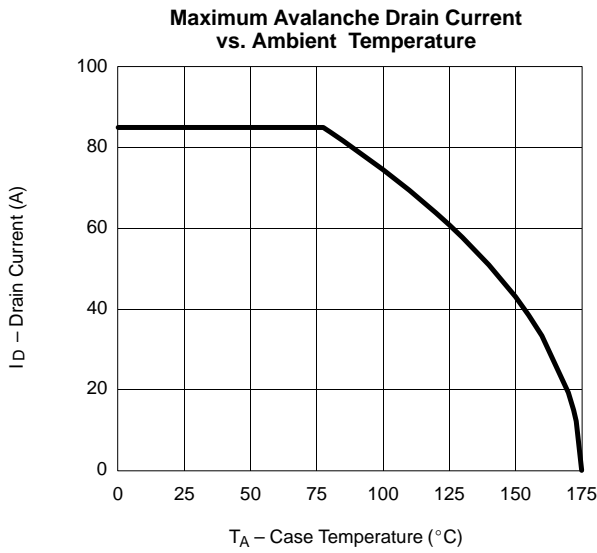

TO-263AB (HIGH VOLTAGE)

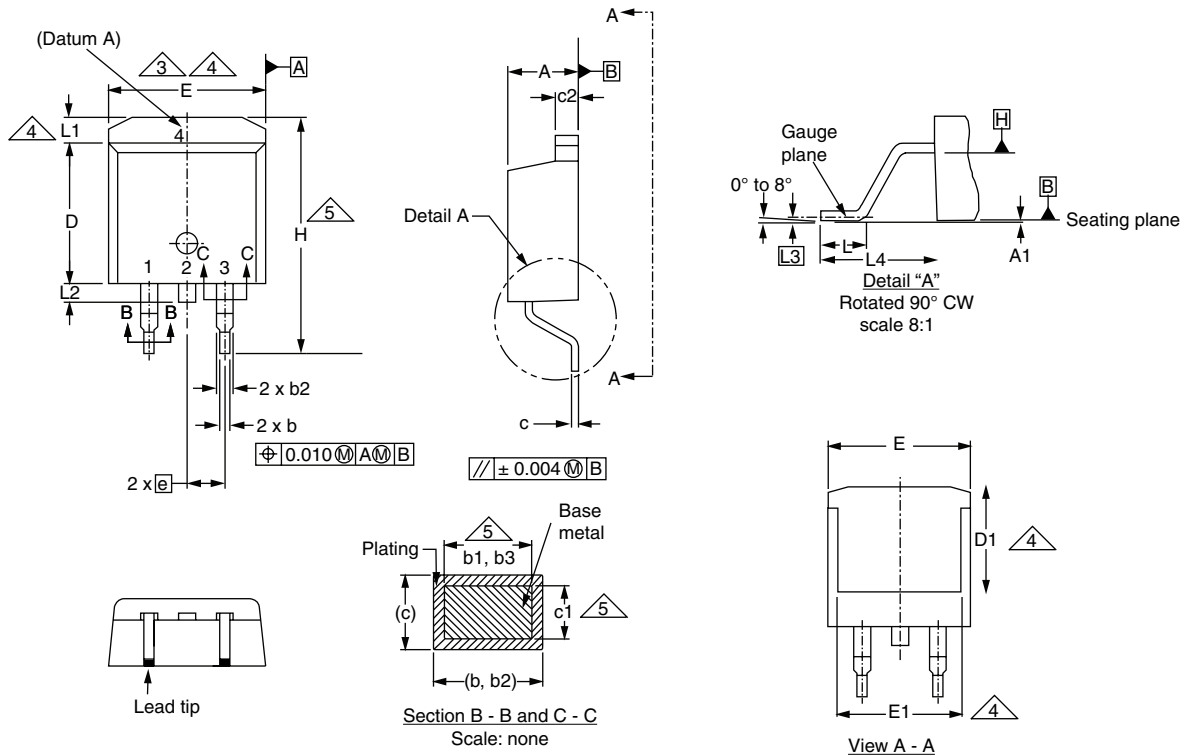

DIM.	MILLIMETERS		INCHES	
	MIN.	MAX.	MIN.	MAX.
A	4.06	4.83	0.160	0.190
A1	0.00	0.25	0.000	0.010
b	0.51	0.99	0.020	0.039
b1	0.51	0.89	0.020	0.035
b2	1.14	1.78	0.045	0.070
b3	1.14	1.73	0.045	0.068
c	0.38	0.74	0.015	0.029
c1	0.38	0.58	0.015	0.023
c2	1.14	1.65	0.045	0.065
D	8.38	9.65	0.330	0.380

DIM.	MILLIMETERS		INCHES	
	MIN.	MAX.	MIN.	MAX.
D1	6.86	-	0.270	-
E	9.65	10.67	0.380	0.420
E1	6.22	-	0.245	-
e	2.54 BSC		0.100 BSC	
H	14.61	15.88	0.575	0.625
L	1.78	2.79	0.070	0.110
L1	-	1.65	-	0.066
L2	-	1.78	-	0.070
L3	0.25 BSC		0.010 BSC	
L4	4.78	5.28	0.188	0.208

ECN: S-82110-Rev. A, 15-Sep-08
DWG: 5970

Notes

1. Dimensioning and tolerancing per ASME Y14.5M-1994.
2. Dimensions are shown in millimeters (inches).
3. Dimension D and E do not include mold flash. Mold flash shall not exceed 0.127 mm (0.005") per side. These dimensions are measured at the outmost extremes of the plastic body at datum A.
4. Thermal PAD contour optional within dimension E, L1, D1 and E1.
5. Dimension b1 and c1 apply to base metal only.
6. Datum A and B to be determined at datum plane H.
7. Outline conforms to JEDEC outline to TO-263AB.

RECOMMENDED MINIMUM PADS FOR D²PAK: 3-Lead

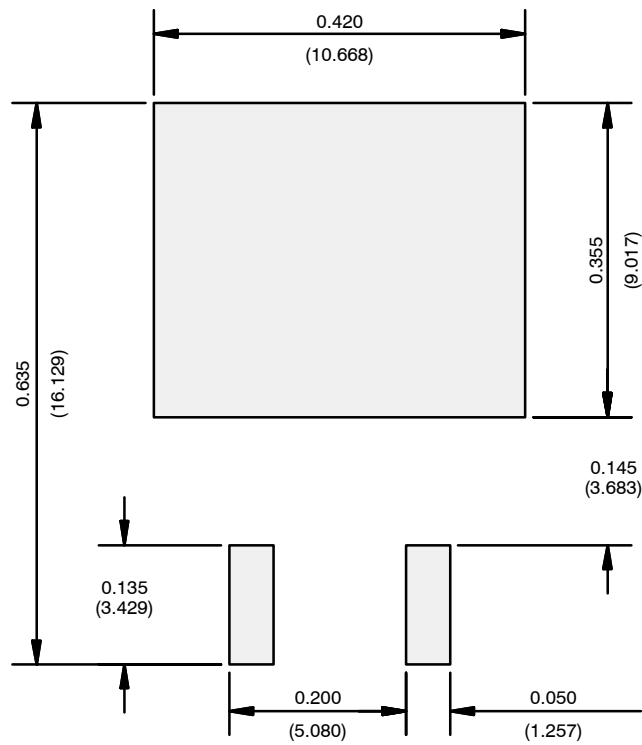

Recommended Minimum Pads
Dimensions in Inches/(mm)

Disclaimer

All products due to improve reliability, function or design or for other reasons, product specifications and data are subject to change without notice.

Taiwan VBsemi Electronics Co., Ltd., branches, agents, employees, and all persons acting on its or their representatives (collectively, the "Taiwan VBsemi"), assumes no responsibility for any errors, inaccuracies or incomplete data contained in the table or any other any disclosure of any information related to the product.(www.VBsemi.com)

Taiwan VBsemi makes no guarantee, representation or warranty on the product for any particular purpose of any goods or continuous production. To the maximum extent permitted by applicable law on Taiwan VBsemi relinquished: (1) any application and all liability arising out of or use of any products; (2) any and all liability, including but not limited to special, consequential damages or incidental ; (3) any and all implied warranties, including a particular purpose, non-infringement and merchantability guarantee.

Statement on certain types of applications are based on knowledge of the product is often used in a typical application of the general product VBsemi Taiwan demand that the Taiwan VBsemi of. Statement on whether the product is suitable for a particular application is non-binding. It is the customer's responsibility to verify specific product features in the products described in the specification is appropriate for use in a particular application. Parameter data sheets and technical specifications can be provided may vary depending on the application and performance over time. All operating parameters, including typical parameters must be made by customer's technical experts validated for each customer application. Product specifications do not expand or modify Taiwan VBsemi purchasing terms and conditions, including but not limited to warranty herein.

Unless expressly stated in writing, Taiwan VBsemi products are not intended for use in medical, life saving, or life sustaining applications or any other application. Wherein VBsemi product failure could lead to personal injury or death, use or sale of products used in Taiwan VBsemi such applications using client did not express their own risk. Contact your authorized Taiwan VBsemi people who are related to product design applications and other terms and conditions in writing.

The information provided in this document and the company's products without a license, express or implied, by estoppel or otherwise, to any intellectual property rights granted to the VBsemi act or document. Product names and trademarks referred to herein are trademarks of their respective representatives will be all.

Material Category Policy

Taiwan VBsemi Electronics Co., Ltd., hereby certify that all of the products are determined to be oHS compliant and meets the definition of restrictions under Directive of the European Parliament 2011/65 / EU, 2011 Nian. 6. 8 Ri Yue restrict the use of certain hazardous substances in electrical and electronic equipment (EEE) - modification, unless otherwise specified as inconsistent.(www.VBsemi.com)

Please note that some documents may still refer to Taiwan VBsemi RoHS Directive 2002/95 / EC. We confirm that all products identified as consistent with the Directive 2002/95 / EC European Directive 2011/65 /.

Taiwan VBsemi Electronics Co., Ltd. hereby certify that all of its products comply identified as halogen-free halogen-free standards required by the JEDEC JS709A. Please note that some Taiwanese VBsemi documents still refer to the definition of IEC 61249-2-21, and we are sure that all products conform to confirm compliance with IEC 61249-2-21 standard level JS709A.