

### 1.产品介绍

AH602是一款小型多功能经济型的线性霍尔传感器。工作原理是当磁场输入时，输出和输入量是成比例变化电压，静态输出电压大小由电源电压设定。该传感器具有低噪声输出，无需外部滤波的特点。可电气元件连接，无需缓冲。同时还包括精密电阻，以提供更好的温度稳定性和准确性。工作温度范围为-40° C~150° C，适用于消费类电子、工业和医疗环境。提供T092S和S0T23-3L两种封装形式，且符合RoHS标准。

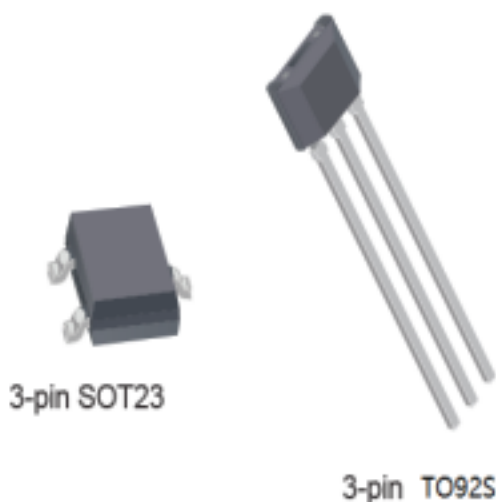

### 2.产品功能

- 体积小
- 能耗低5mA 5VDC
- 电压范围为3VDC~12VDC
- 低噪声输出
- 工作温度范围为-40° C~150° C
- 对南极和北极磁场作出不同反应
- ESD 性能可达±4kV

### 3.应用领域

- 电流检测
- 电机控制
- 位置检测
- 磁力计
- 旋转编码器
- 金属探测器
- 液位传感器
- 重量传感器

### 4.产品包装

产品型号	封装形式	温度范围	成品包装
AH602UA	T092S	-40°C~150°C	1000/袋
AH602SU	S0T23-3L	-40°C~150°C	3000/卷



### 目录

1. 产品介绍.....	1
2. 产品功能.....	1
3. 应用领域.....	1
4. 产品包装.....	1
5. 功能框图.....	3
6. 引脚信息.....	3
7. 应用实例 ( $V_{CC}=5V$ ).....	3
8. 绝对最大值.....	4
9. 电气特性 ( $T_A=25^{\circ}C$ , $V_{CC}=5.0V$ ) .....	4
10. 典型特性曲线.....	5
11. 应用电路.....	7
12. 封装信息.....	7
13. 注意事项.....	9

# AH602

## 低阶线性霍尔芯片



Alfa Electronics Co.,Ltd

### 5.功能框图

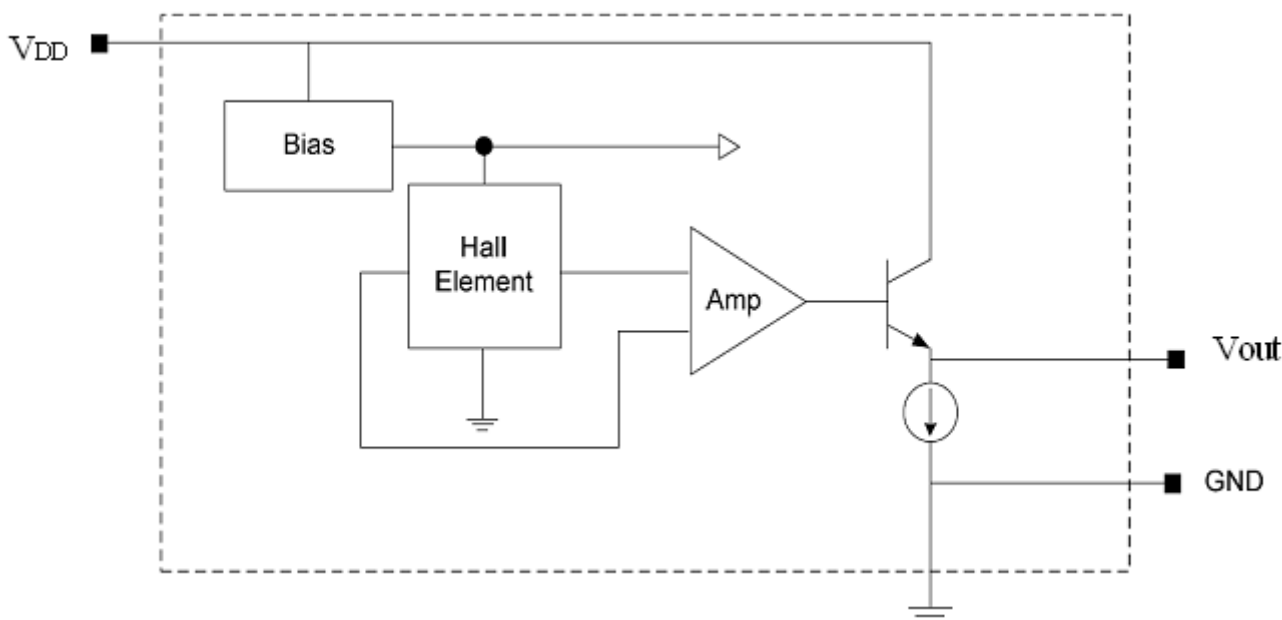

### 6.引脚信息

描述	SOT23	T092S	符号
电源	1	1	V <sub>cc</sub>
输出	2	3	V <sub>out</sub>
地线	3	2	GND

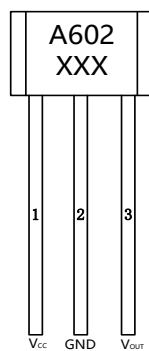

T092S

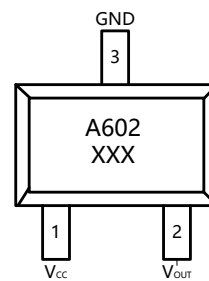

SOT23-3L

### 7.应用实例(V<sub>CC</sub>=5V)

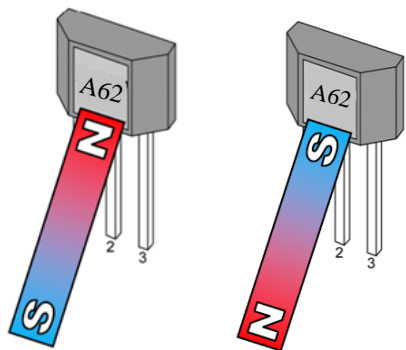

V<sub>OUT</sub>=低电压      V<sub>OUT</sub>=高电压  
T092S (AH602)

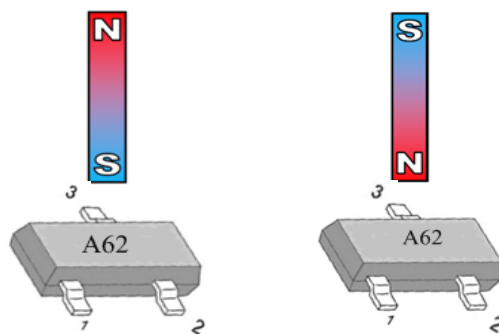

V<sub>OUT</sub>=低电压      V<sub>OUT</sub>=高电压  
SOT23 (AH602)

### 8.绝对最大值

绝对最大额定值是芯片所能承受的极限值，超过该值芯片可能会永久损坏。

参数	符号	最小值	最大值	单位
电源电压	$V_{CC}$	-0.5	15	V
输出电压	$V_{OUT}$	-0.5	15	V
输出电流	$I_{OUT}$	0	5	mA
操作温度范围	$T_A$	-40	150	°C
储存温度范围	$T_S$	-50	165	°C

### 9.电气特性 ( $T_A=25^{\circ}C$ , $V_{CC}=5.0V$ )

参数	符号	测试条件	最小值	典型值	最大值	单位
操作电压	$V_{CC}$		3	5	12	V
供电电流	$I_{CC}$		3	5	8	mA
输出电流	$I_{OUT}$				1.5	mA
响应时间	Tack			3		uS
静态输出电压	$V_o$	B=0	2.25	2.5	2.75	V
灵敏度	Sen		2.2	2.5	2.8	mV/G
最小输出电压	$V_{min}$	B=-600G		1		V
最大输出电压	$V_{max}$	B=600G		4		V
输出负载电阻	$R_L$	$ \Delta V_{OUT}  < 15mV$	200			KOhm

### 10. 典型特性曲线

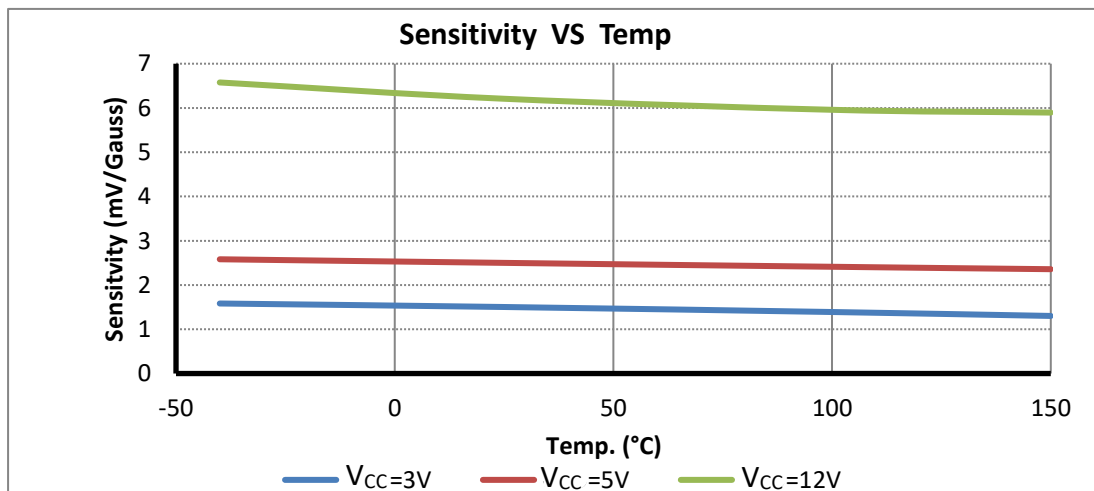
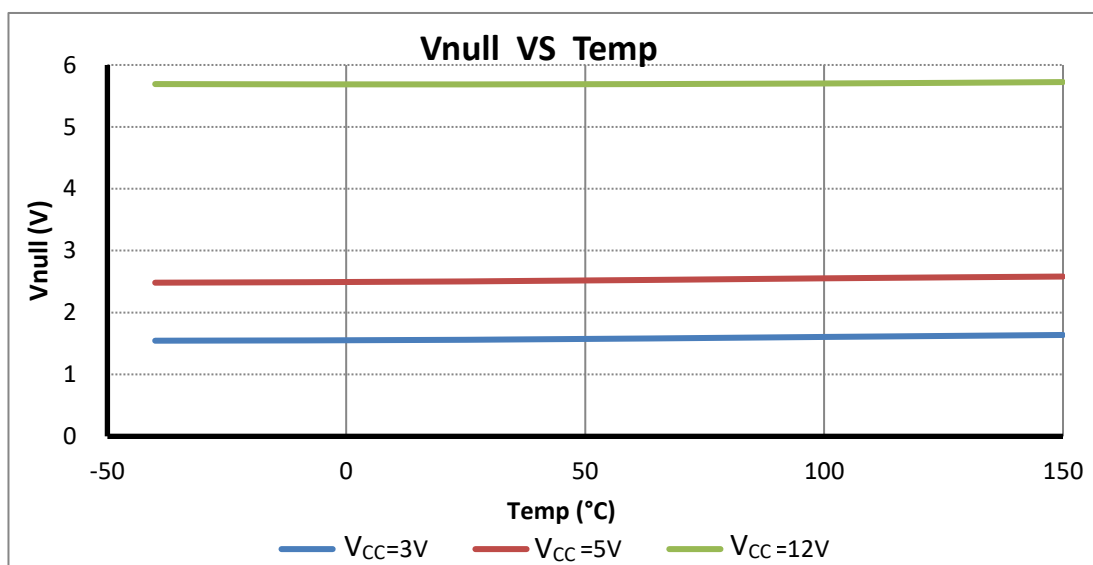
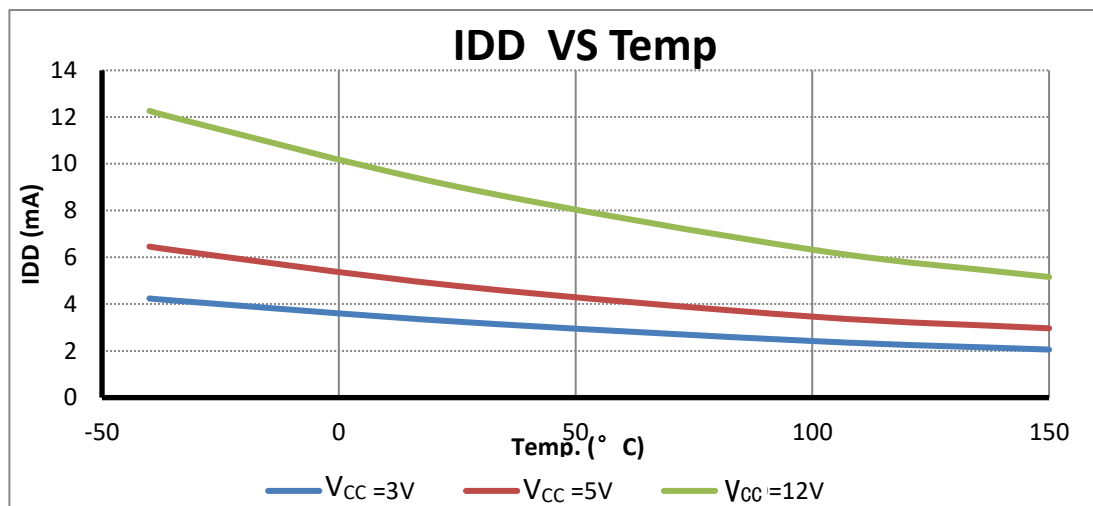

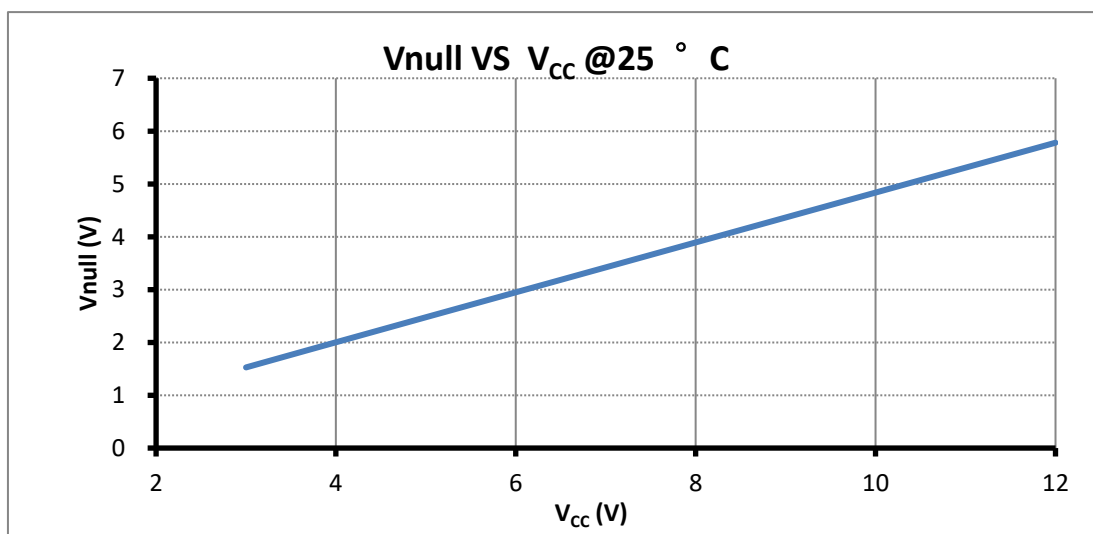
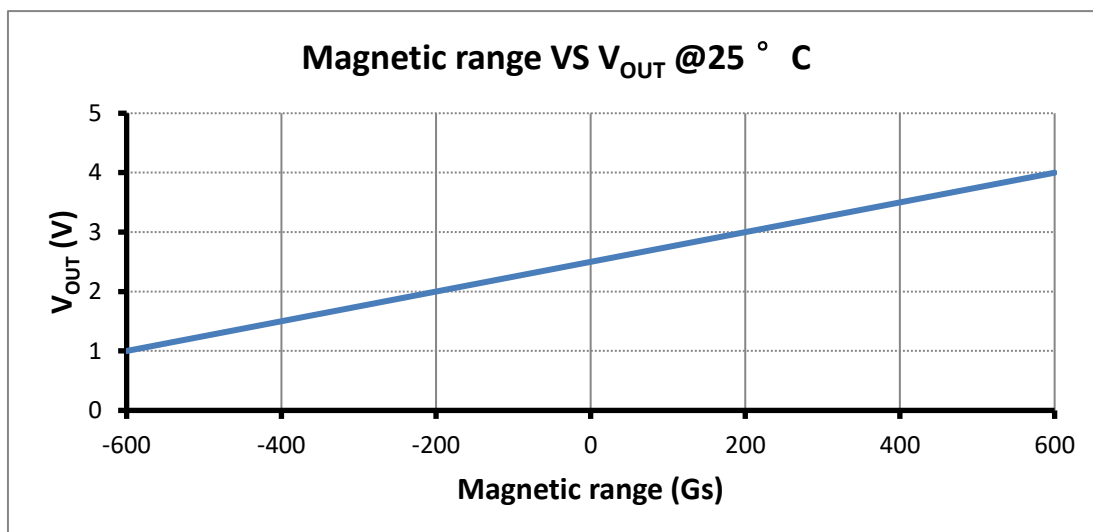
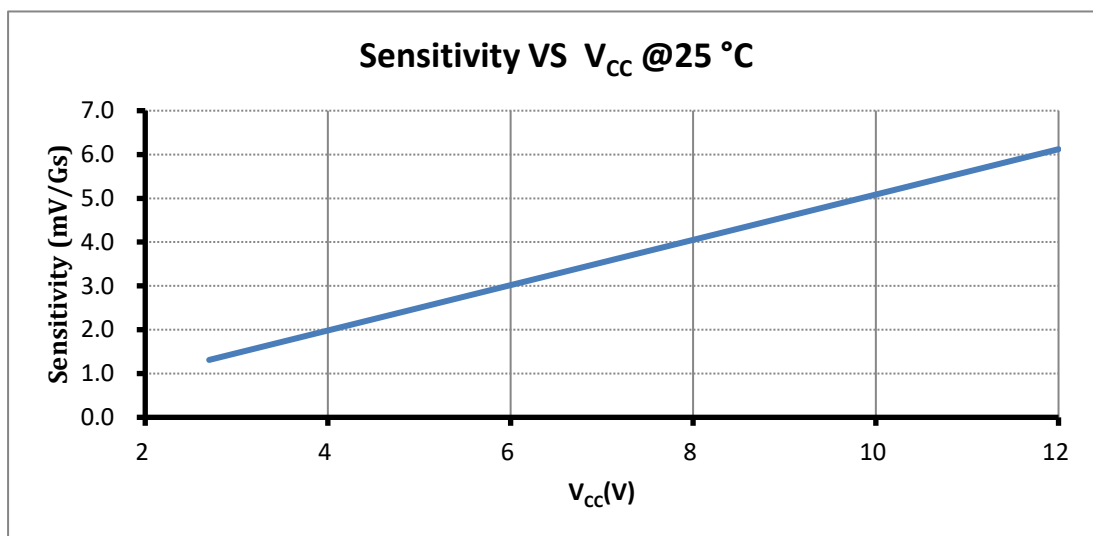

# AH602

## 低阶线性霍尔芯片



Alfa Electronics Co.,Ltd

### 11.应用电路

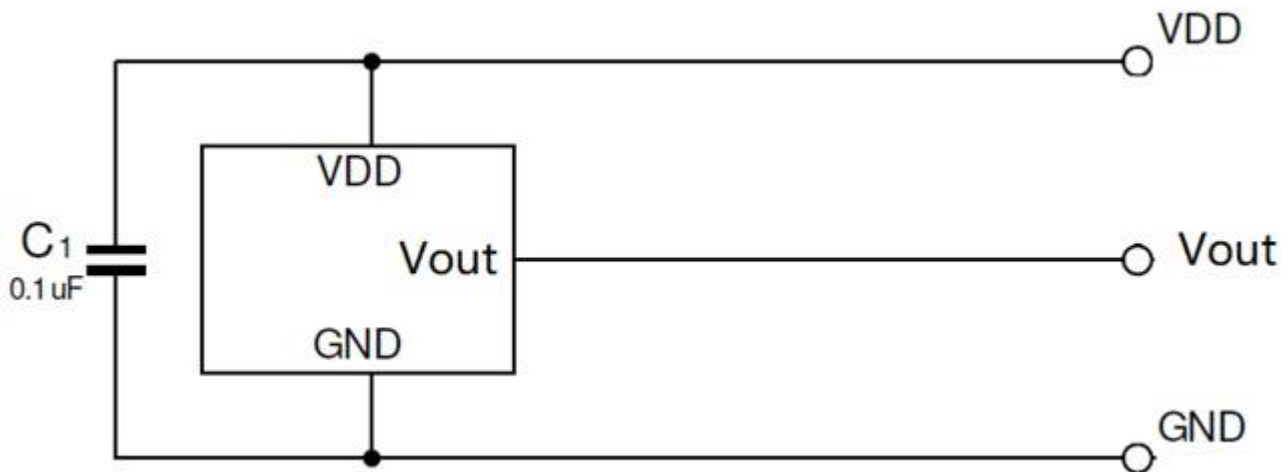

### 12.封装信息

#### T092S 封装尺寸

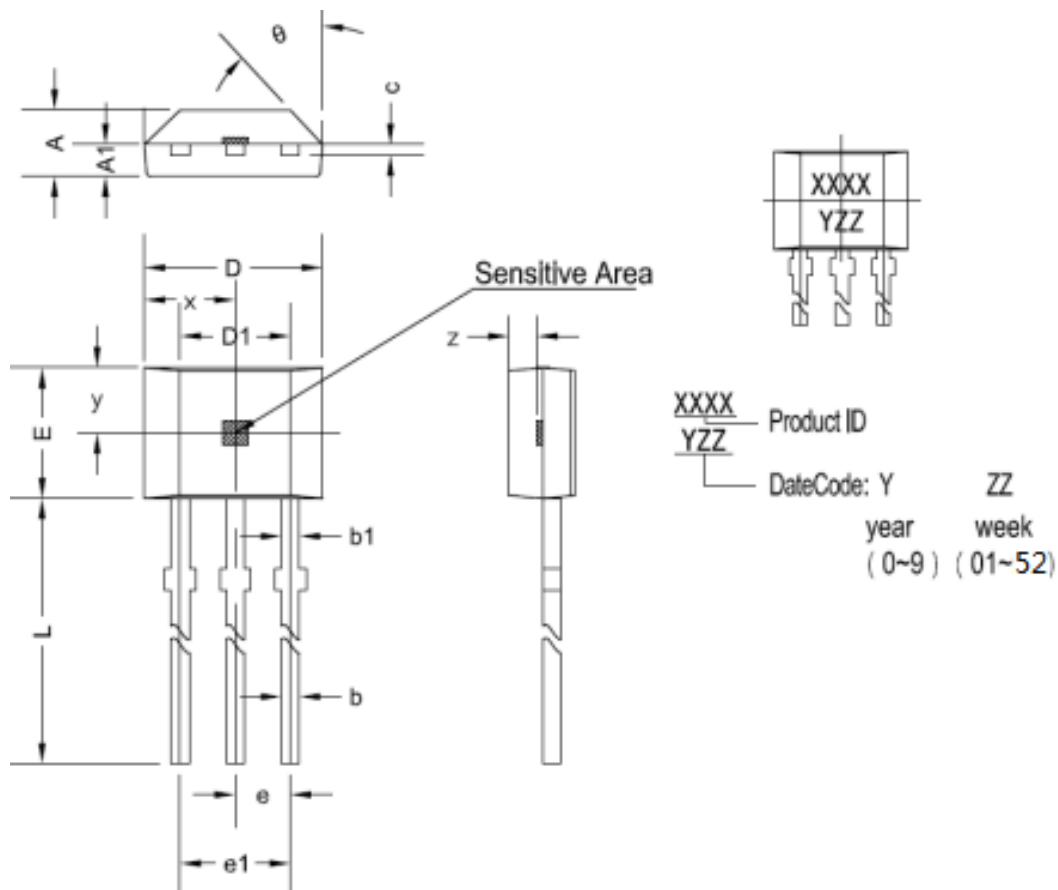

# AH602

## 低阶线性霍尔芯片



Alfa Electronics Co.,Ltd

符号	尺寸 (毫米)		尺寸 (英寸)	
	最小值	最大值	最小值	最大值
A	1.420	1.670	0.056	0.066
A1	0.660	0.860	0.026	0.034
b	0.350	0.560	0.014	0.022
b1	0.400	0.550	0.016	0.022
C	0.360	0.510	0.014	0.020
D	3.900	4.200	0.154	0.165
D1	2.970	3.270	0.117	0.129
E	2.900	3.280	0.114	0.129
e	1.270TYP		0.050TYP	
e1	2.440	2.640	0.096	0.104
L	13.500	15.500	0.531	0.610
x	2.025TYP		0.080TYP	
y	1.545TYP		0.061TYP	
z	0.500TYP		0.020TYP	
$\theta$	45°TYP		45°TYP	

### SOT23-3L 封装尺寸

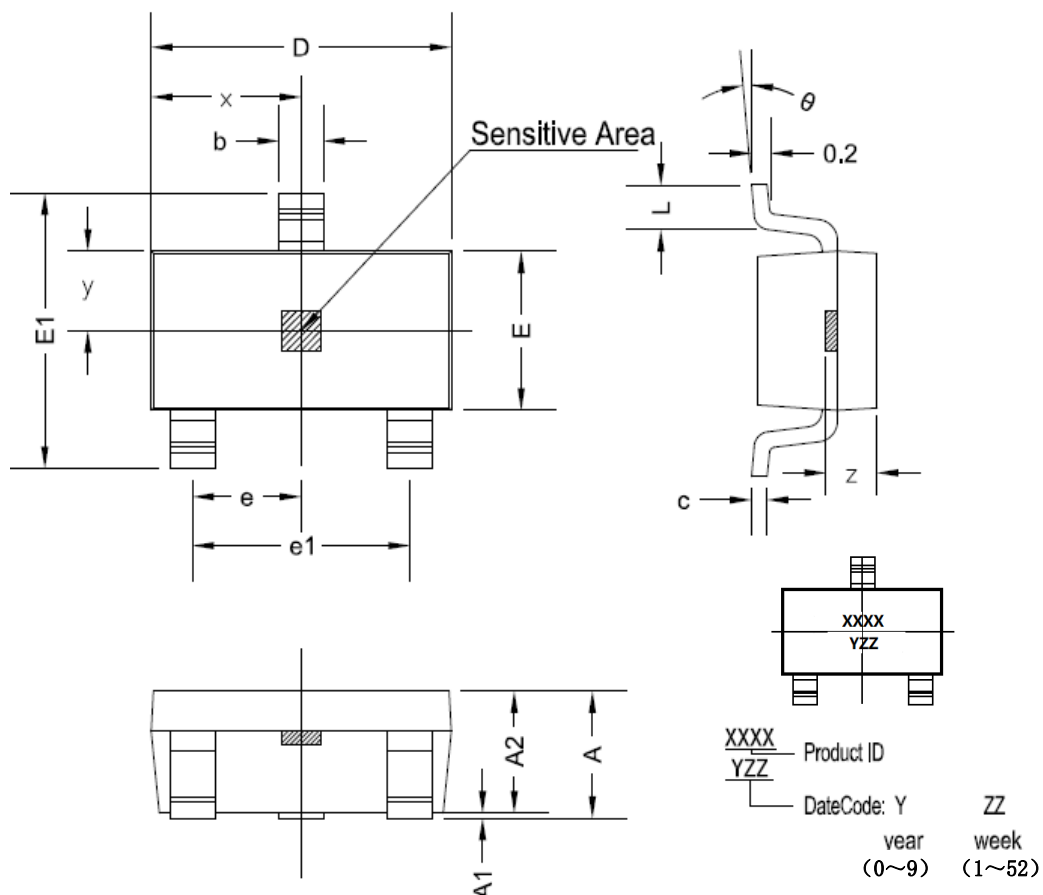



# AH602

## 低阶线性霍尔芯片



Alfa Electronics Co.,Ltd

符号	尺寸(毫米)		尺寸(英寸)	
	最小值	最大值	最小值	最大值
A	1.050	1.250	0.041	0.049
A1	0.000	0.100	0.000	0.004
A2	1.050	1.150	0.041	0.045
b	0.300	0.500	0.012	0.020
c	0.100	0.200	0.004	0.008
D	2.820	3.020	0.111	0.119
E	1.500	1.700	0.059	0.067
E1	2.650	2.950	0.104	0.116
e	0.950TYP		0.037TYP	
e1	1.800	2.000	0.071	0.079
L	0.300	0.600	0.012	0.024
x	1.460TYP		0.057TYP	
y	0.800TYP		0.032TYP	
z	0.600TYP		0.024TYP	
$\theta$	0°	8°	0°	8°

### 13. 注意事项

- 霍尔是敏感器件，在使用及存储过程中应注意采取静电防护措施。
- 在安装使用中应尽量减少施加到器件外壳和引线上的机械应力。
- 建议焊接温度不超过 350°C，持续时间不超过 5 秒。
- 为保证霍尔芯片的安全性和稳定性，不建议长期超出参数范围使用。

# AH602

## 低阶线性霍尔芯片



Alfa Electronics Co.,Ltd

Copyright ©2018, Alfa Electronics Co., Ltd

Alfa Electronics Co., Ltd reserves the right to make, from time to time, such departures from the detail specifications as may be required to permit improvements in the performance, reliability, or manufacturability of its products. Before placing an order, the user is cautioned to verify that the information being relied upon is current.

Alfa's products are not to be used in any devices or systems, including but not limited to life support devices or systems, in which a failure of Alfa's product can reasonably be expected to cause bodily harm.

The information included herein is believed to be accurate and reliable. However, Alfa Electronics Co., Ltd assumes no responsibility for its use; nor for any infringement of patents or other rights of third parties which may result from its use.