

0.85V Minimum Input and 5.5V Maximum Output High Efficiency 2A Valley Current Synchronous Boost

General Description

SY7072A is a high efficient, synchronous, step-up Boost converter designed for one-cell Li-Ion or Li-polymer, or a two to three-cell alkaline Ni-Cd or Ni-MH battery powered applications. It can convert down to 0.85V input voltage. It adopts NMOS for the main switch and PMOS for the synchronous switch.

SY7072A can disconnect the output from input during the shutdown mode. When input voltage exceeds the regulated output voltage, SY7072A enters bypass mode automatically.

Features

- 0.85V Minimum Input Voltage
- Adjustable Output Voltage from 1.8V to 5.5V
- Min 2A Valley Current Limit
- 5 μ A Typical Quiescent Current
- Load Disconnect During Shutdown
- Low $R_{DS(ON)}$ (Main Switch/Synchronous Switch) at 3.3V Output: 100/170m Ω
- Output OVP
- RoHS Compliant and Halogen Free
- Auto Bypass Mode When $V_{IN} \geq V_{OUT}$
- Compact Package SOT23-6

Ordering Information

SY7072

Temperature Code
Package Code
Optional Spec Code

Ordering Number	Package type	Note
SY7072AABC	SOT23-6	----

Applications

- All Single Cell Li or Dual Cell Battery Operated Products as MP-3 Player, PDAs, and Other Portable Equipment

Typical Applications

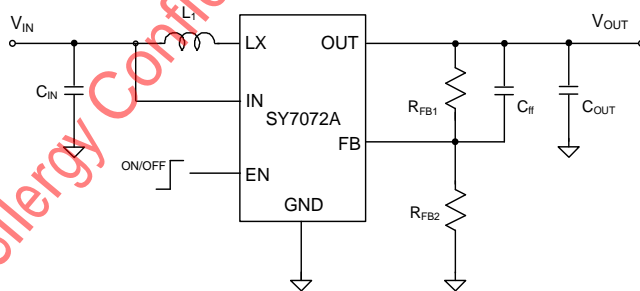

Figure 1. Schematic Diagram

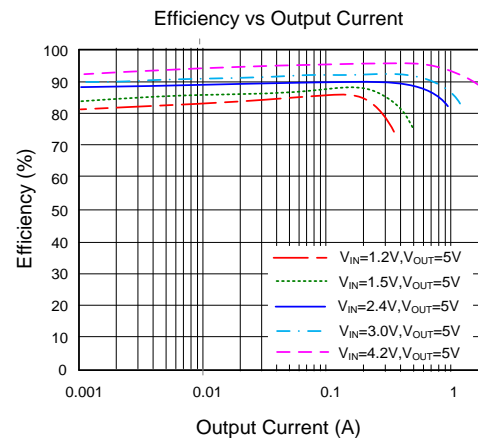

Figure 2. Efficiency vs. Load Current



SILERGY

SY7072A

Pinout (top view)

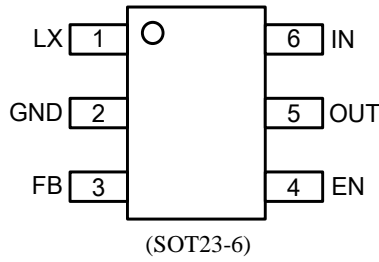

Top mark: cKxyz for SY7072AABC (Device code: cK, x=year code, y=week code, z= lot number code)

Pin Name	Pin Number	Pin Description
LX	1	Inductor node. Connect an inductor between the IN pin and the LX pin.
GND	2	Ground pin.
FB	3	Feedback pin. Connect a resistor R_{FB1} between OUT and FB, and a resistor R_{FB2} between FB and GND to program the output voltage. $V_{OUT}=1.2V \times (R_{FB1}/R_{FB2}+1)$.
EN	4	Enable pin. Pull high to turn on. Do not leave it floating.
OUT	5	Output pin. Decouple this pin to the GND pin with a minimum of 22 μ F ceramic capacitor.
IN	6	Input pin.

Block Diagram

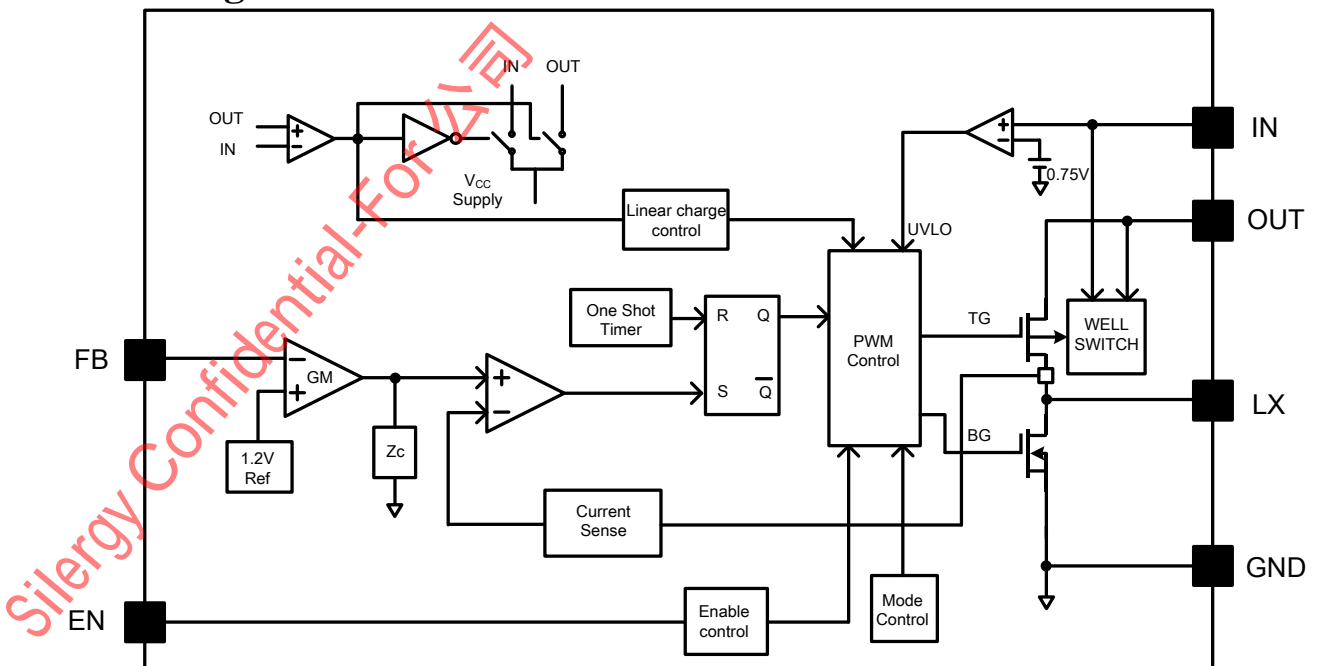

Figure3. Block Diagram



Absolute Maximum Ratings (Note 1)

FB, IN, OUT, EN	-----	-0.3V to 6.0V
LX	-----	-0.3V ^(*1) to 6.0V ^(*2)
Power Dissipation, P _D @ T _A =25°C SOT23-6	-----	1W
Package Thermal Resistance (Note 2)		
θ _{JA}	-----	100°C/W
θ _{JC}	-----	30°C/W
Junction Temperature Range	-----	-40°C to 150°C
Lead Temperature (Soldering, 10 sec.)	-----	260°C
Storage Temperature Range	-----	-65°C to 150°C

(*1) LX Voltage tested down to -3V < 20ns

(*2) LX Voltage tested up to +7V < 20ns

Recommended Operating Conditions (Note 3)

IN	-----	0.85V to 5.5V
OUT	-----	1.8V to 5.5V
EN	-----	0V to V _{OUT} +0.3V
All Other Pins	-----	0 to 5.5V
Junction Temperature Range	-----	-40°C to 125°C
Ambient Temperature Range	-----	-40°C to 85°C

Silergy Confidential-For 公司

**Electrical Characteristics**(V_{IN}=2.4V, V_{OUT}=3.3V, I_{OUT}=500mA, T_A = 25°C, unless otherwise specified)

Parameter	Symbol	Test Conditions	Min	Typ	Max	Unit
Input Voltage Range	V _{IN}		0.85		5.5	V
Input UVLO Threshold	V _{UVLO}			0.7	0.85	V
Input UVLO Hysteresis	V _{HYS}			0.04		V
Quiescent Current	V _{IN}	V _{FB} =1.3V, V _{EN} =V _{IN} =1V, V _{OUT} =3.4V		0.7		μA
	V _{OUT}			5		μA
Shutdown Current	I _{SHDN}	V _{EN} =0V, V _{IN} =2.4V		0.1	1	μA
Linear Charge Current	I _{CHARGE}	V _{OUT} <0.5V _{IN}		1		A
Feedback Reference Voltage	V _{REF}		1.182	1.2	1.218	V
Low Side Main FET R _{ON}	R _{DS(ON)1}			100		mΩ
Synchronous FET R _{ON}	R _{DS(ON)2}			170		mΩ
EN Input Voltage High	V _{EN,H}	V _{IN} ≤1.6V and V _{OUT} ≤1.6V	0.7			V
		V _{IN} >1.6V or V _{OUT} >1.6V	1.2			V
EN Input Voltage Low	V _{EN,L}	V _{IN} ≤1.6V and V _{OUT} ≤1.6V			0.25	V
		V _{IN} >1.6V or V _{OUT} >1.6V			0.4	V
EN Leakage Current	I _{EN,LK}	V _{EN} =3.3V	-1		1	μA
Min ON Time	t _{ON,MIN}			60		ns
Min OFF Time	t _{OFF,MIN}			140		ns
Soft-start Time	t _{SS}			1		ms
Switching Frequency	f _{SW}	V _{OUT} =3.3V, CCM		1		MHz
Valley FET Current Limit	I _{LMT,VAL}		2			A
Output Over Voltage Threshold	V _{OV}			5.8		V
Output Over Voltage Hysteresis	V _{OV,HYS}			0.3		V
Thermal Shutdown Temperature	T _{SD}			150		°C
Thermal Shutdown Hysteresis	T _{HYS}			20		°C

Note 1: Stresses beyond the “Absolute Maximum Ratings” may cause permanent damage to the device. These are stress ratings only. Functional operation of the device at these or any other conditions beyond those indicated in the operational sections of the specification is not implied. Exposure to absolute maximum rating conditions may affect device reliability.

Note 2: Package thermal resistance is measured in the natural convection at T_A = 25°C on a two-layer Silergy Evaluation Board.

Note 3: The device is not guaranteed to function outside its operating conditions.

SOT23-6 Package Outline & PCB Layout Design

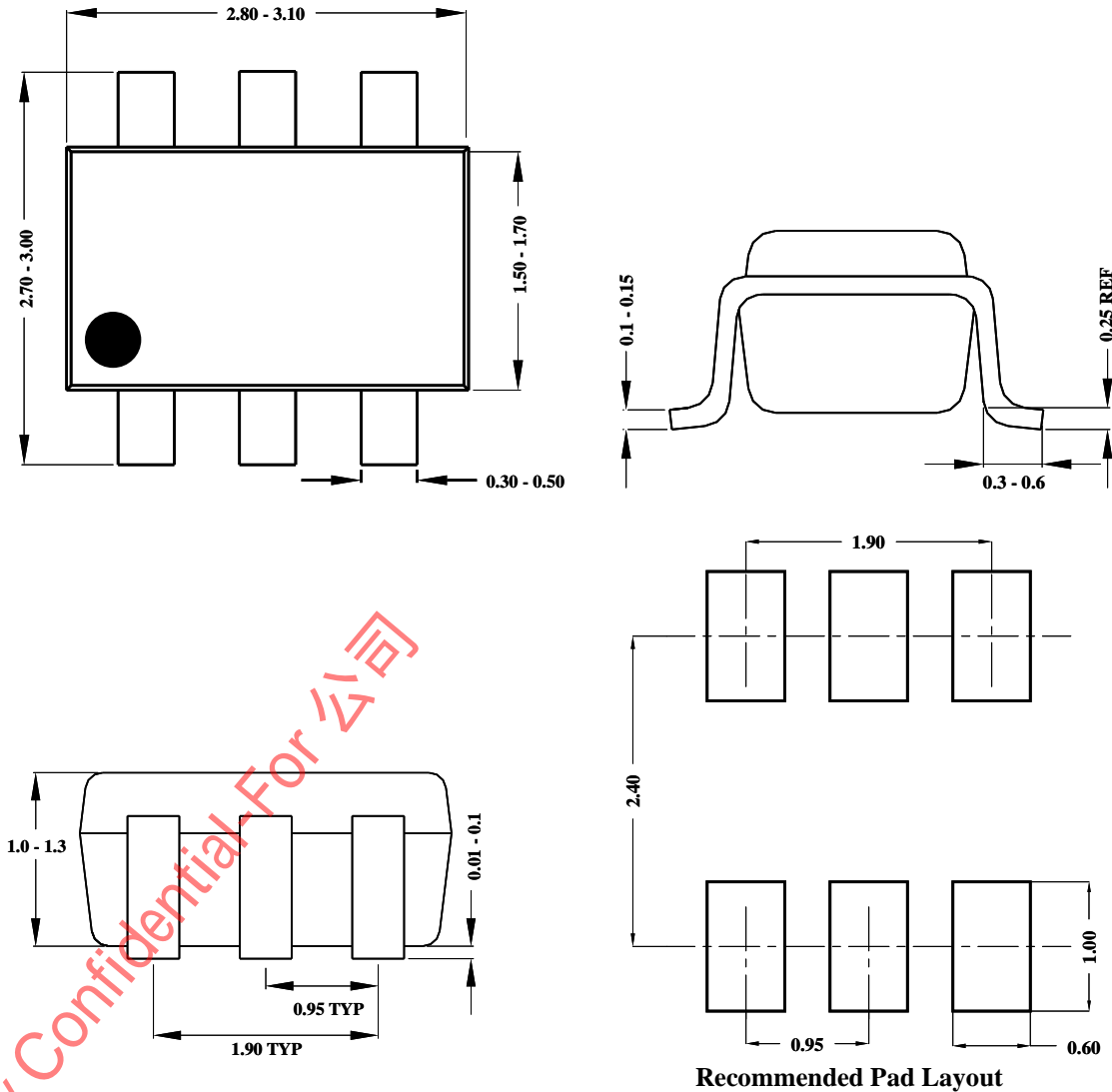

Notes: All dimensions are in millimeters.
All dimensions don't include mold flash & metal burr.

Taping & Reel Specification

1. Taping orientation for packages (SOT23-6)

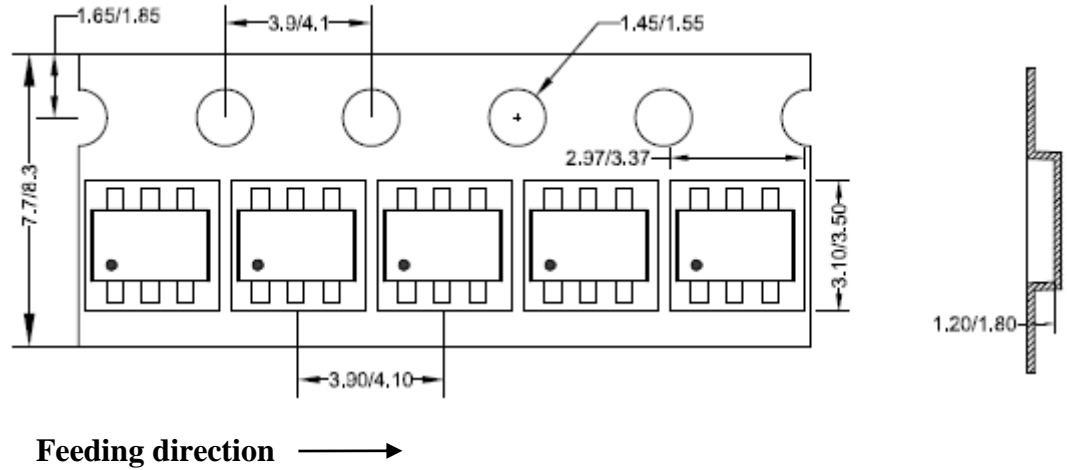

2. Carrier Tape & Reel specification for packages

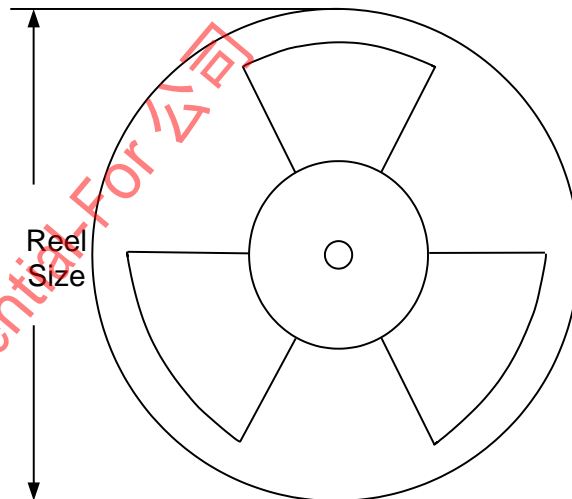

Package type	Tape width (mm)	Pocket pitch(mm)	Reel size (Inch)	Trailer length(mm)	Leader length (mm)	Qty per reel
SOT23-6	8	4	7"	280	160	3000

3. Others: NA