

THIS IS A C.A.D. GENERATED DRAWING  
DO NOT MAKE MANUAL REVISIONS TO MASTER.

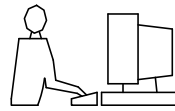

\* UNLESS OTHERWISE SPECIFIED TOLERANCES  
ON DECIMAL IS: ANGLE  $\pm 5^\circ$   
UNIT: MM X.  $\pm 0.38$   
X.X  $\pm 0.25$

**BACKSHELL KIT INCLUDES:**

- (2) BACKSHELL HALVES
- (2) 4-40 THUMBSCREWS
- (2) HOUSING SCREWS
- (1) SET OF COMPRESSION INSERTS - VARIOUS SIZES  
DIAMETERS 4mm (.157"), 5mm (.167"), 7mm (.276"), 9mm (.354")
- (1) COMPRESSION SPRING

Size 9 has both "MH" Logo  
and non-logo versions.  
With Logo=MHDTZK9-K  
No Logo=MHDTZK9-NL-K

Size 15/25/37, only non-logo  
versions are available.

DIMENSIONS(mm/in)

SIZE	A $\pm .50$ $\pm 0.02$	B $\pm .50$ $\pm 0.02$	C $\pm .50$ $\pm 0.02$	D $\pm .25$ $\pm 0.01$
9	31.20	39.90	15.00	24.99
	1.228	1.571	0.591	0.984
15	39.50	41.50	15.00	33.32
	1.555	1.634	0.591	1.312
25	53.40	48.60	15.00	47.04
	2.102	1.913	0.591	1.852
37	69.70	53.60	15.00	63.50
	2.744	2.110	0.591	2.500

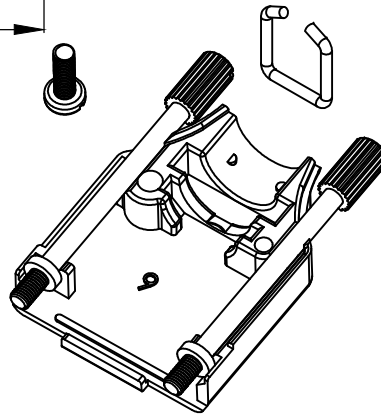
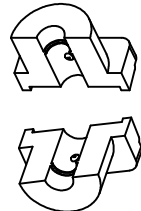
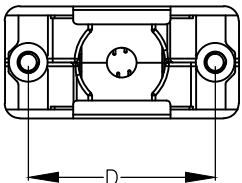
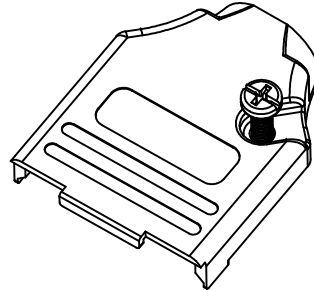
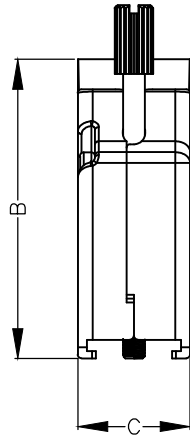
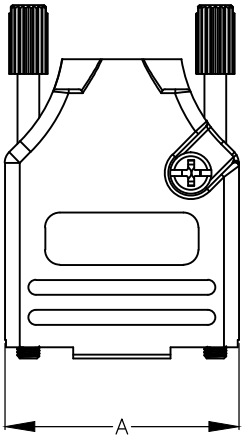

**ORDERING INFORMATION:**

SIZE	P/N - KITTED	PRODUCT CODE:
9-WAY	6560-0805-01	MHDTZK9-K
15-WAY	6560-0805-02	MHDTZK15-K
25-WAY	6560-0805-03	MHDTZK25-K
37-WAY	6560-0805-04	MHDTZK37-K

BACKSHELL MATERIAL:	DIE-CAST ZINC ALLOY
PLATING:	NICKEL
JACKSCREWS:	STEEL: Zn PLATED
M3 HOODSCREWS:	STEEL: Zn PLATED
COMPRESSION INSERT:	ABS, UL RECOGNIZED
COMPRESSION SPRING:	STEEL, NICKEL PLATED
OPERATING TEMP:	-40°C TO +120°C

THESE DRAWINGS AND SPECIFICATIONS ARE THE PROPERTY OF MH CONNECTORS AND SHALL NOT BE REPRODUCED, COPIED OR USED AS THE BASIS FOR THE MANUFACTURE OR SALE OF APPARATUS WITHOUT WRITTEN PERMISSION.

DRAWN Johnny Chen	DATE 06-24-15
----------------------	------------------

APPROVED DAMIEN	DATE 06-30-15
--------------------	------------------

SCALE 1 : 1	SHEET OF 1 OF 1	REV: 3.0
----------------	--------------------	-------------

DRAWING No  
MHDTZK SERIES



THIS SERIES FULLY CONFORMS TO THE EUROPEAN UNION DIRECTIVES 2002/95/EC AND 2002/96/EC FOR RoHS COMPLIANCY.



**MH CONNECTORS ,  
DIVISION OF EDAC**