



### N-Channel Enhancement Mode Power MOSFET

#### General Features

- $V_{DS} = 50V, I_D = 0.3A$

$$R_{DS(ON)} < 3.5\Omega @ V_{GS}=4.5V$$

$$R_{DS(ON)} < 2.5\Omega @ V_{GS}=10V$$

- High power and current handling capability
- Lead free product
- Surface mount package

#### Application

- Direct logic-level interface: TTL/CMOS
- Drivers: relays, solenoids, lamps, hammers, display, memories, transistors, etc.
- Battery operated systems
- Solid-state relays

SOT-323

1. GATE
2. SOURCE
3. DRAIN

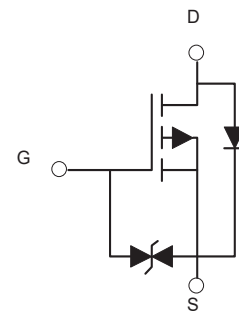
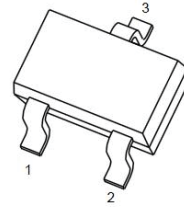

#### Absolute Maximum Ratings ( $T_A=25^\circ C$ unless otherwise noted)

Parameter	Symbol	Limit	Unit
Drain-Source Voltage	$V_{DS}$	50	V
Gate-Source Voltage	$V_{GS}$	$\pm 20$	V
Drain Current-Continuous	$I_D$	0.3	A
Drain Current-Pulsed <sup>(Note 1)</sup>	$I_{DM}$	1.2	A
Maximum Power Dissipation @25°C	$P_D$	0.2	W
Operating Junction and Storage Temperature Range	$T_J, T_{STG}$	-55 To 150	°C

#### Thermal Characteristic

Thermal Resistance, Junction-to-Ambient <sup>(Note 2)</sup>	$R_{\theta JA}$	620	°C/W
---	-----------------	-----	------

#### Electrical Characteristics ( $T_A=25^\circ C$ unless otherwise noted)

Parameter	Symbol	Condition	Min	Typ	Max	Unit
<b>Off Characteristics</b>						
Drain-Source Breakdown Voltage	$BV_{DSS}$	$V_{GS}=0V, I_D=250\mu A$	50		-	V
Zero Gate Voltage Drain Current	$I_{DSS}$	$V_{DS}=50V, V_{GS}=0V$	-	-	1	$\mu A$



Gate-Body Leakage Current	$I_{GSS}$	$V_{GS}=\pm 10V, V_{DS}=0V$	-	$\pm 110$	$\pm 500$	nA
		$V_{GS}=\pm 12V, V_{DS}=0V$	-	$\pm 0.3$	$\pm 10$	$\mu A$
<b>On Characteristics</b> (Note 3)						
Gate Threshold Voltage	$V_{GS(th)}$	$V_{DS}=V_{GS}, I_D=250\mu A$	0.6	1.0	1.4	V
Drain-Source On-State Resistance	$R_{DS(on)}$	$V_{GS}=4.5V, I_D=0.2A$	-		3.5	$\Omega$
		$V_{GS}=10V, I_D=0.2A$	-	1	2.5	$\Omega$
Forward Transconductance	$g_{FS}$	$V_{DS}=10V, I_D=0.2A$	0.2	-	-	S
<b>Dynamic Characteristics</b> (Note 4)						
Input Capacitance	$C_{iss}$	$V_{DS}=25V, V_{GS}=0V,$ $F=1.0MHz$	-	30	-	PF
Output Capacitance	$C_{oss}$		-	15	-	PF
Reverse Transfer Capacitance	$C_{rss}$		-	6	-	PF
<b>Switching Characteristics</b> (Note 4)						
Turn-on Delay Time	$t_{d(on)}$	$V_{DD}=30V, I_D=0.22A$ $V_{GS}=10V, R_{GEN}=6\Omega$	-	-	5	nS
Turn-on Rise Time	$t_r$		-	-	5	nS
Turn-Off Delay Time	$t_{d(off)}$		-	-	60	nS
Turn-Off Fall Time	$t_f$		-	-	35	nS
Total Gate Charge	$Q_g$	$V_{DS}=25V, I_D=0.2A,$ $V_{GS}=10V$	-	-	2.4	nC
<b>Drain-Source Diode Characteristics</b>						
Diode Forward Voltage (Note 3)	$V_{SD}$	$V_{GS}=0V, I_S=0.22A$	-	-	1.0	V
Diode Forward Current (Note 2)	$I_S$		-	-	0.22	A

### Notes:

1. Repetitive Rating: Pulse width limited by maximum junction temperature.
2. Surface Mounted on FR4 Board,  $t \leq 10$  sec.
3. Pulse Test: Pulse Width  $\leq 300\mu s$ , Duty Cycle  $\leq 2\%$ .
4. Guaranteed by design, not subject to production



### Typical Electrical and Thermal Characteristics

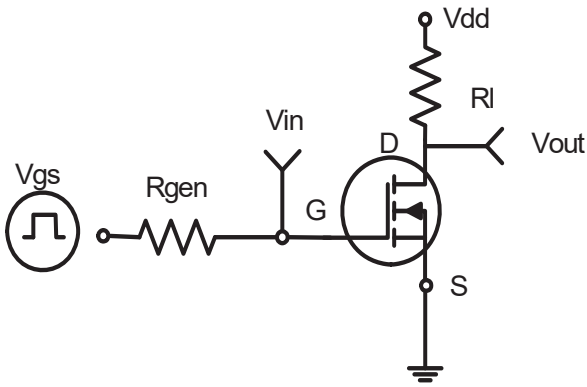

Figure 1: Switching Test Circuit

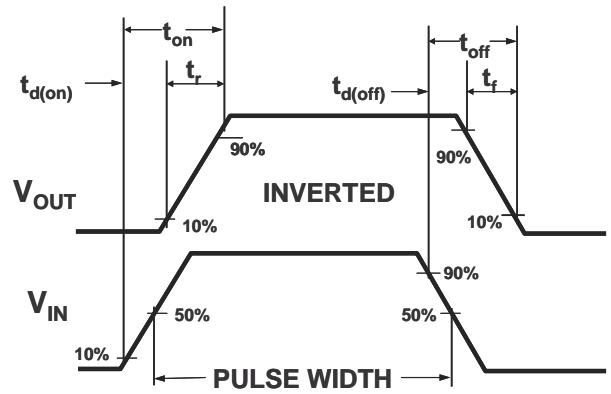

Figure 2: Switching Waveforms

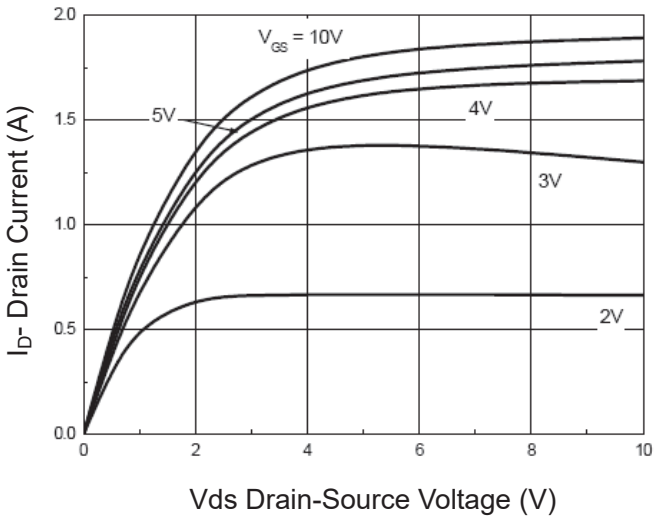

Figure 3 Output Characteristics

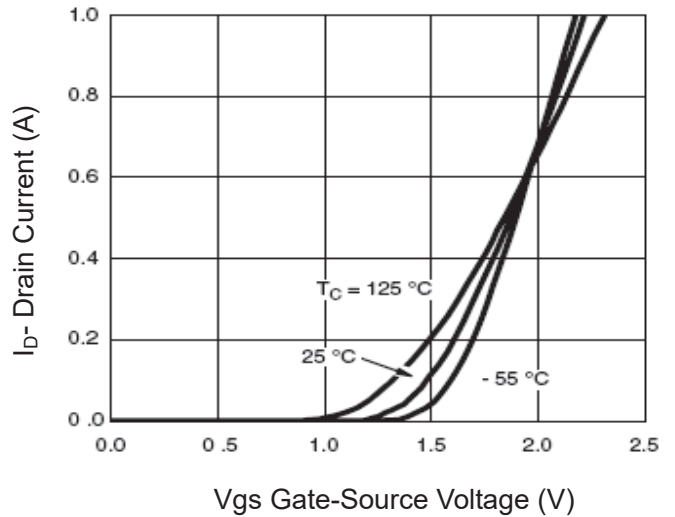

Figure 4 Transfer Characteristics

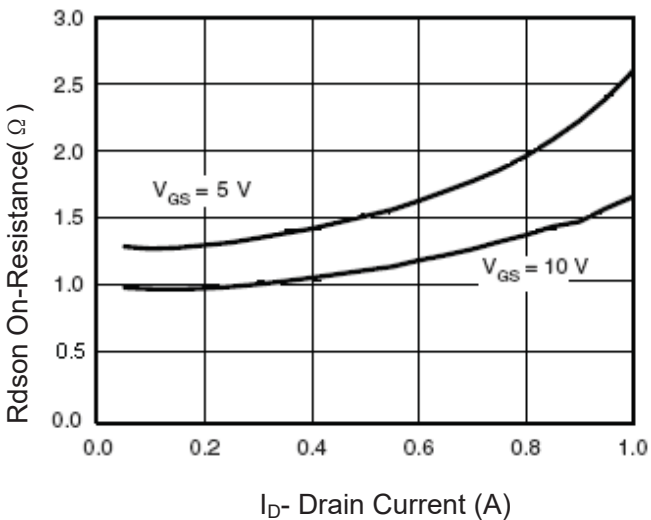

Figure 5 Drain-Source On-Resistance

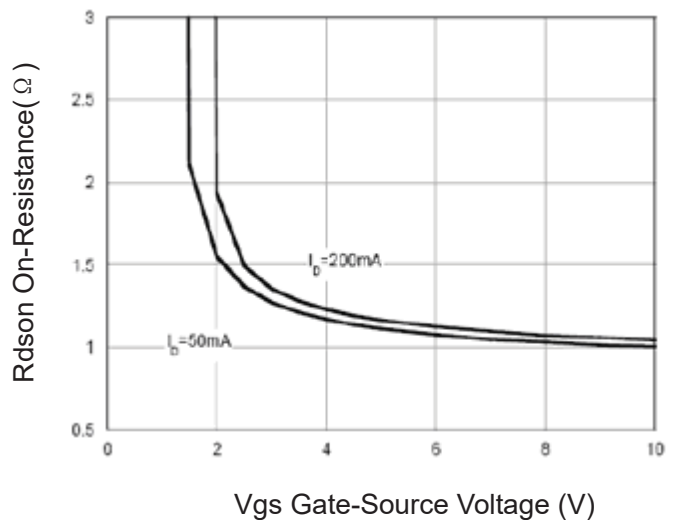
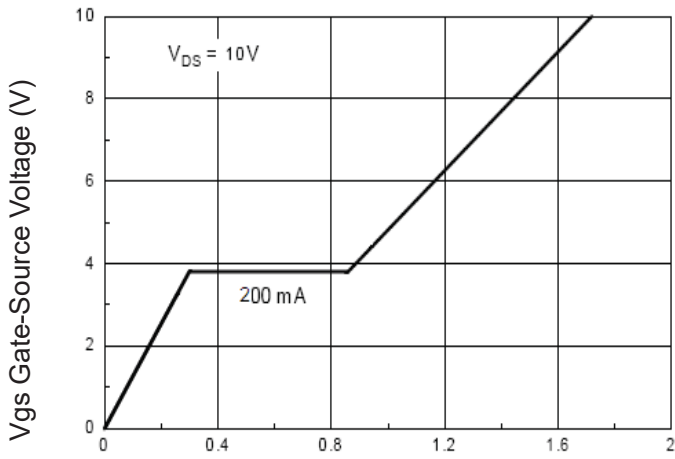
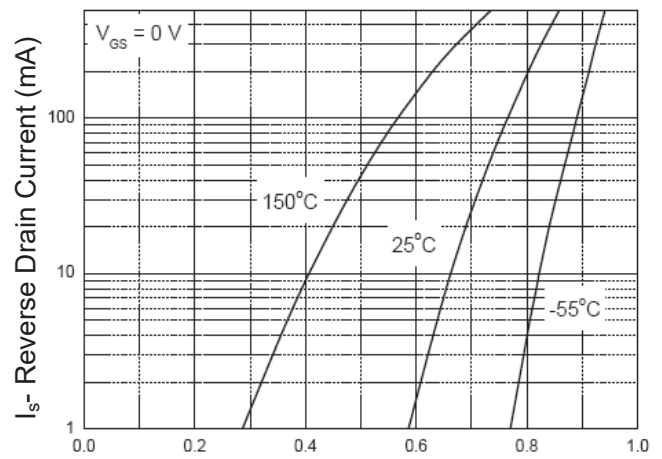

Figure 6 Rdson vs Vgs



Qg Gate Charge (nC)  
**Figure 7 Gate Charge**



Vds Source-Drain Voltage (V)  
**Figure 8 Source-Drain Diode Forward**

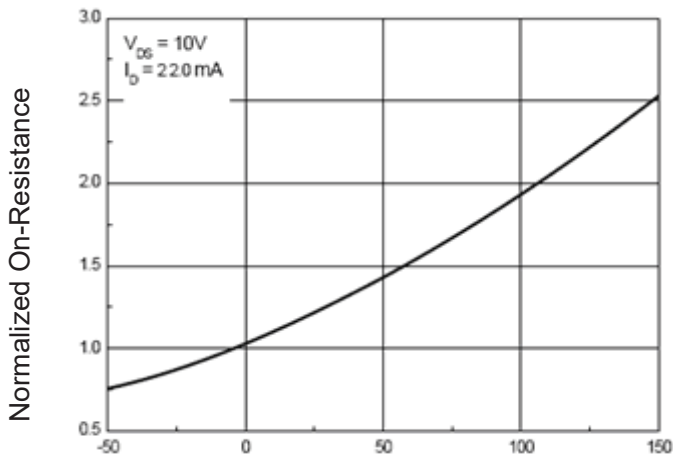

TJ-Junction Temperature(°C)  
**Figure 9 Drain-Source On-Resistance**

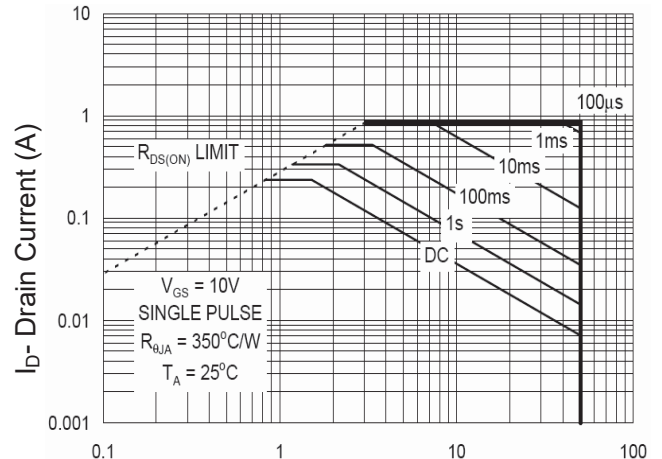

Vds Drain-Source Voltage (V)  
**Figure 10 Safe Operation Area**

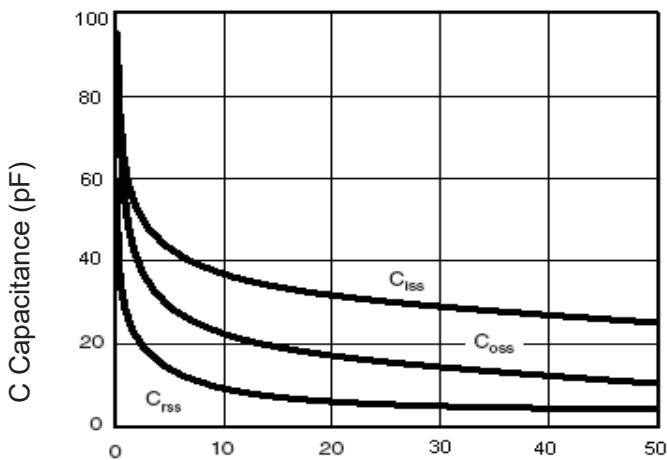

Vds Drain-Source Voltage (V)  
**Figure 11 Capacitance vs Vds**

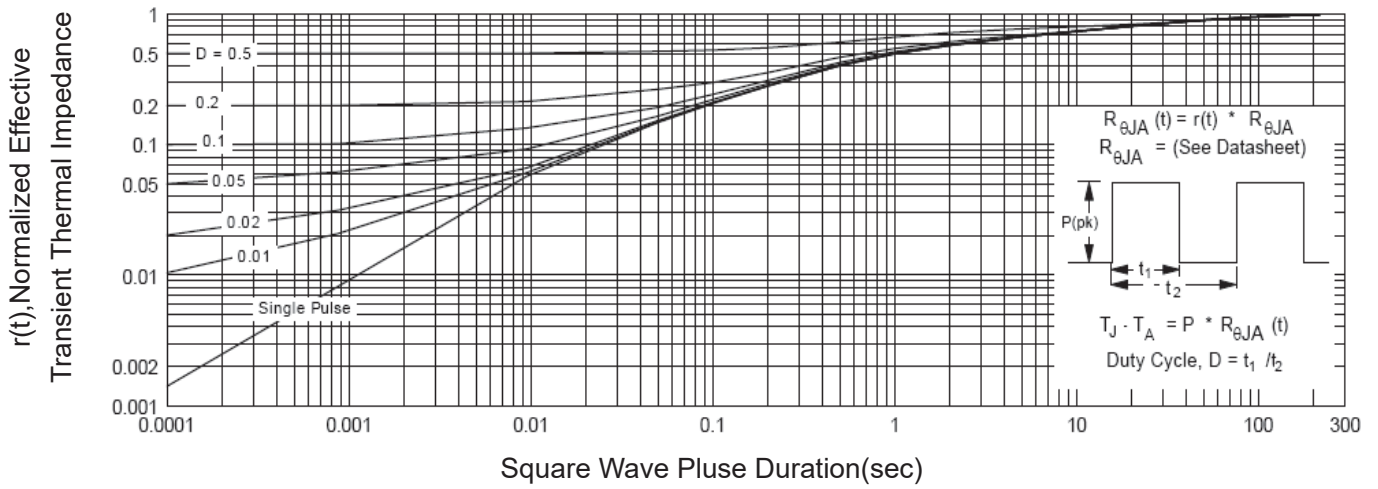
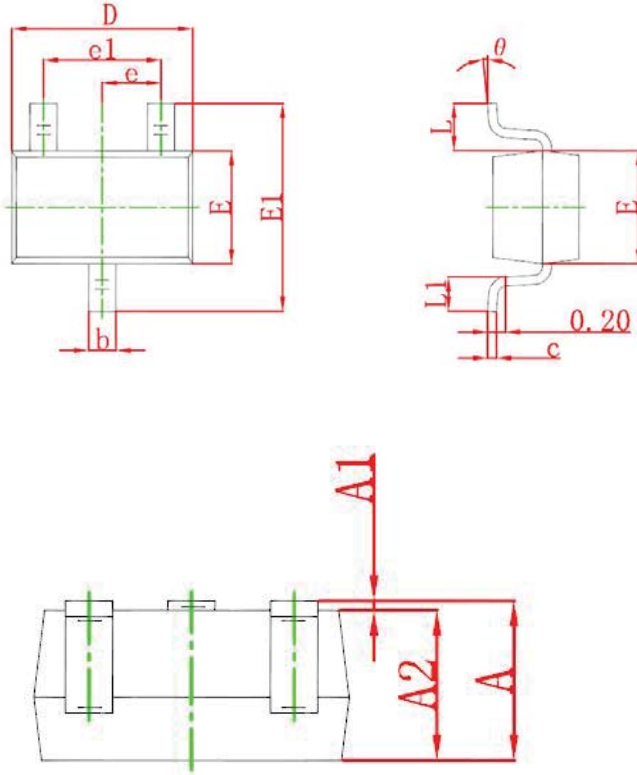

Figure 12 Normalized Maximum Transient Thermal Impedance



### SOT-323 Package Information



Symbol	Dimensions In Millimeters		Dimensions In Inches	
	Min	Max	Min	Max
A	0.900	1.100	0.035	0.043
A1	0.000	0.100	0.000	0.004
A2	0.900	1.000	0.035	0.039
b	0.200	0.400	0.008	0.016
c	0.080	0.150	0.003	0.006
D	2.000	2.200	0.079	0.087
E	1.150	1.350	0.045	0.053
E1	2.150	2.450	0.085	0.096
e	0.650 TYP		0.026 TYP	
e1	1.200	1.400	0.047	0.055
L	0.525 REF		0.021 REF	
L1	0.260	0.460	0.010	0.018
θ	0°	8°	0°	8°