

SCHEMATIC

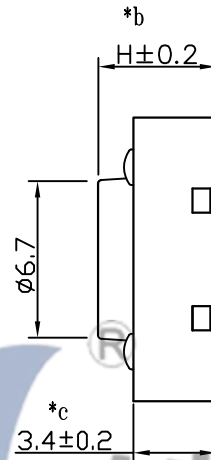

SPECIFICATION

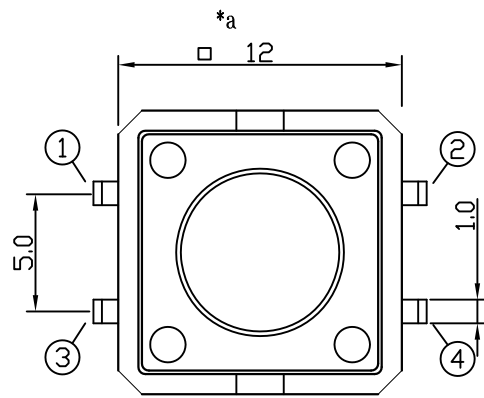

1. Rating : DC12V 50mA.
2. Contact resistance:  $\leq 100\Omega$ .
3. Insulation resistance:  $\geq 100M\Omega$  (DC250V).
4. Withstanding voltage: 250VAC .
5. Operating Force:  $250 \pm 80gf$
6. Travel:  $0.25 \pm 0.1mm$ .
7. life test: 5,0000 cycles.
8. Operation temperature range:  $-25^{\circ}C \sim 85^{\circ}C$ .
9. Sign"\* "is importance dimension.

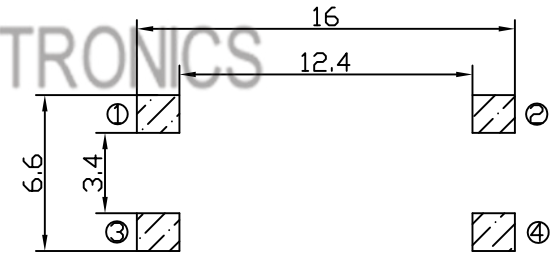
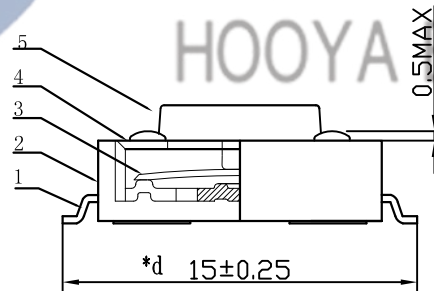
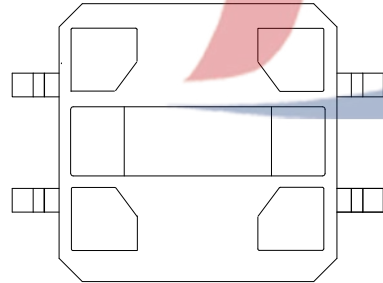
TEL:0769-82310510-867



P.C.B LAYOUT

H=7.3mm

				TOLERANCE UNLESS SPECIFIED						
				<1.5: $\pm 0.1mm$	ANGULAR $\pm 1^{\circ}$	1				
				>1.5~5.0: $\pm 0.25mm$			NO	DATE	REVISIONS	
				>5.0: $\pm 0.3mm$			UNIT : MM	ROHS COMPLIANT	DWN	
5	STEM	PPA	1	BLACK	TITLE: SLIDE SWITCH		SCALE: 1:1	CHK'D		
4	COVER	SUS	1	WHITE	MODEL: TC-06121-073E-01			APPD		
3	CONTACT	SUS	1	Ag-Plated	 DONGGUANG HAOYU ELECTRONICS CO., LTD 东莞市弘皓电子有限公司		PRO.AGL:			REV :A1
2	CASE	PPA	1	BLACK						
1	TERMINAL	BRASS	4	Ag-Plated						
NO.	PART NAME	MATERIAL	QTY	FINISHING						