

Features

- ❑ Transient protection for high-speed data lines
 - IEC 61000-4-2 (ESD) ±25kV (Air)
 - ±17kV (Contact)
 - IEC 61000-4-4 (EFT) 40A (5/50 ns)
 - Cable Discharge Event (CDE)
- ❑ Protects two data lines
- ❑ Low capacitance: 0.5 pF Typical (I/O-I/O)
- ❑ Low leakage current: 0.1µA @ V_{RWM} (Typical)
- ❑ Low clamping voltage
- ❑ Each I/O pin can withstand over 1000 ESD strikes for ±8kV contact discharge

Description

TT0512TLX is an ultra-low capacitance Transient Voltage Suppressor (TVS) designed to provide electrostatic discharge (ESD) protection for high-speed data interfaces. With typical capacitance of 0.5 pF only, TT0512TLX is designed to protect parasitic-sensitive systems against over-voltage and over-current transient events. It complies with IEC 61000-4-2 (ESD), Level 4 (±15kV air, ±8kV contact discharge), IEC 61000-4-4 (electrical fast transient - EFT) (40A, 5/50 ns), very fast charged device model (CDM) ESD and cable discharge event (CDE), etc.

TT0512TLX uses small SOT23-6L package. Each TT0512TLX device can protect two high-speed data lines. The combined features of low capacitance, small size and high ESD robustness make TT0512TLX ideal for high-speed data ports and high-frequency lines (e.g., USB 2.0 & DVI) applications. The low clamping voltage of the TT0512 TLX guarantees a minimum stress on the protected IC.

Applications

- ❑ Serial ATA
- ❑ PCI Express
- ❑ Desktops, Servers and Notebooks
- ❑ MDDI Ports
- ❑ USB2.0 Power and Data Line Protection
- ❑ Display Ports
- ❑ Digital Visual Interfaces (DVI)

Mechanical Characteristics

- ❑ SOT23-6L package
- ❑ Flammability Rating: UL 94V-0
- ❑ Marking: Part number, Date
- ❑ Packaging: Tape and Reel

Circuit Diagram

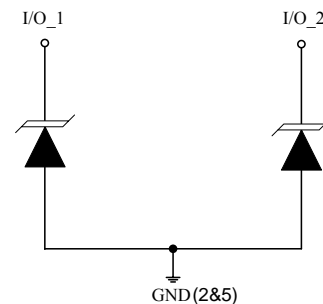

Pin Configuration

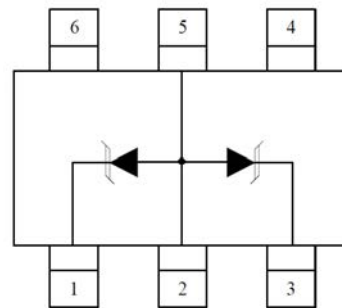

SOT23-6L
(Top View)

Absolute Maximum Rating

Symbol	Parameter	Value	Units
V_{ESD}	ESD per IEC 61000-4-2 (Air)	±25	kV
	ESD per IEC 61000-4-2 (Contact)	±17	
T_{OPT}	Operating Temperature	-55/+125	°C
T_{STG}	Storage Temperature	-55/+150	°C

Electrical Characteristics (T = 25°C)

Symbol	Parameter
V_{RWM}	Nominal Reverse Working Voltage
I_R	Reverse Leakage Current @ V_{RWM}
V_{BR}	Reverse Breakdown Voltage @ I_T
I_T	Test Current for Reverse Breakdown
V_C	Clamping Voltage @ I_{PP}
I_{PP}	Maximum Peak Pulse Current
C_{ESD}	Parasitic Capacitance
V_R	Reverse Voltage
f	Small Signal Frequency
I_F	Forward Current
V_F	Forward Voltage @ I_F

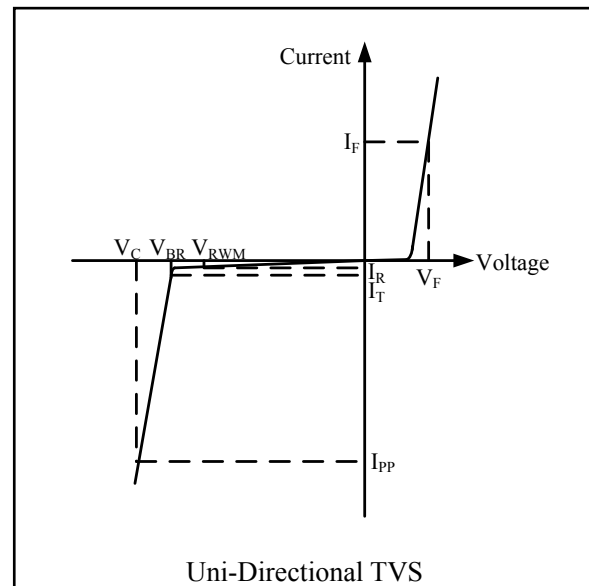

Symbol	Test Condition	Minimum	Typical	Maximum	Units
V_{RWM}				5.0	V
I_R	$V_{RWM} = 5V, T = 25^\circ C$ Between I/O and GND		0.1	1.0	μA
V_{BR}	$I_T = 1mA$ Between I/O and GND	6.0	8.0	10.0	V
V_C	$I_{PP} = 1A, t_p = 8/20\mu s$ Between I/O and GND			12	V
C_{ESD}	$V_R = 0V, f = 1MHz$ Between I/O and GND		0.5	0.8	pF
C_{ESD}	$V_R = 0V, f = 1MHz$ Between I/O and I/O		0.25	0.5	pF

Voltage Sweeping of I/O to GND

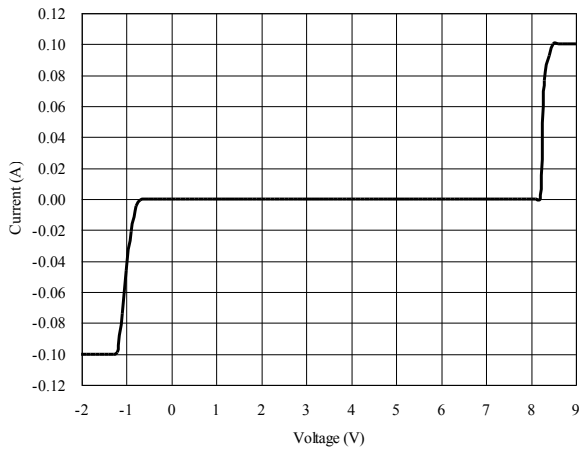

Insertion Loss S21 of I/O to GND

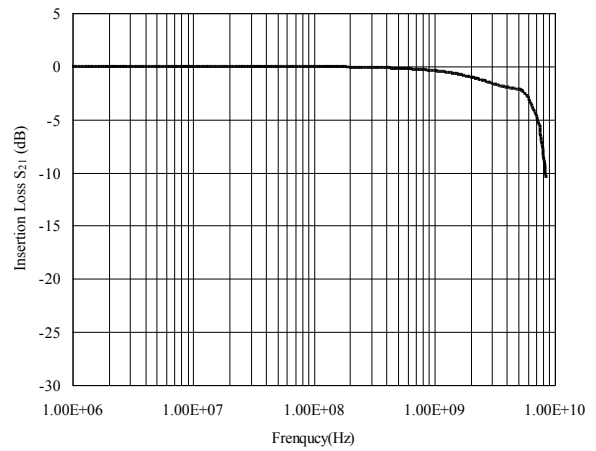

Capacitance vs. Voltage of I/O to I/O (f = 1MHz)

Capacitance vs. Reverse Voltage

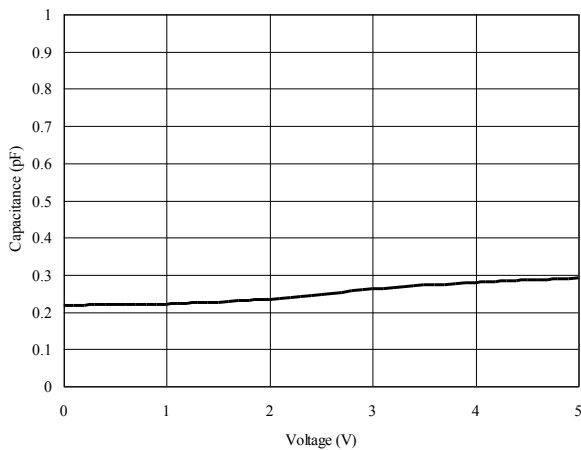

Normalized Capacitance vs. Reverse Voltage

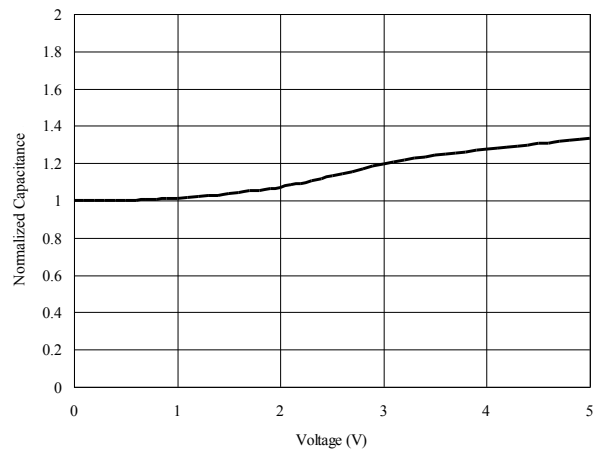

ESD Clamping (+8kV Contact per IEC 61000-4-2)

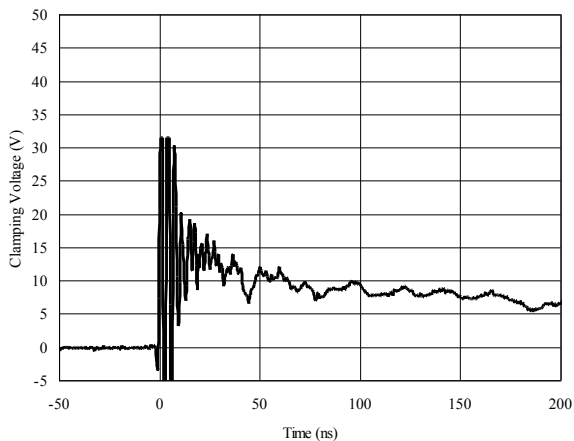

ESD Clamping (-8kV Contact per IEC 61000-4-2)

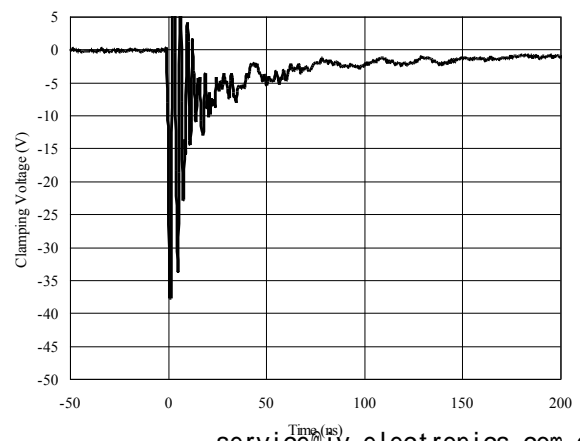

Application Information

Pin Connection in PCB

TT0512TLX is capable to provide ESD protection for two data lines simultaneously. The pin connection is shown in Figure 1.

Two parallel data lines, from inner IC to I/O port connector, could connect to TT0512TLX two I/O pins directly. Pin 2 5 of TT0512TLX is the negative reference pin, which should connect to the GND of PCB. The connection wires should be as short as possible in order to minimize the parasitic inductance.

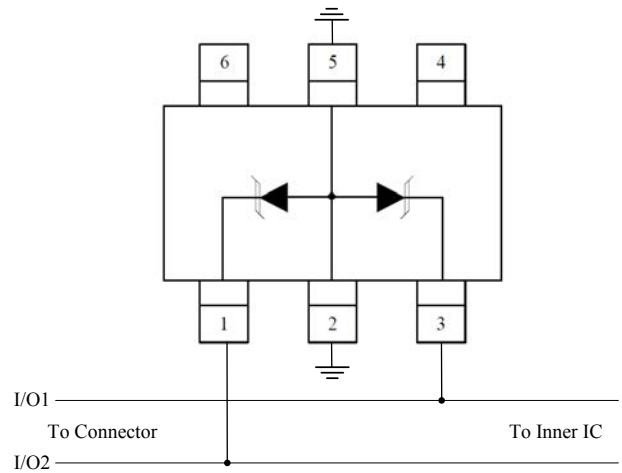

Figure 1 TT0512TLX pin connection in PCB

Universal Serial Bus ESD Protection

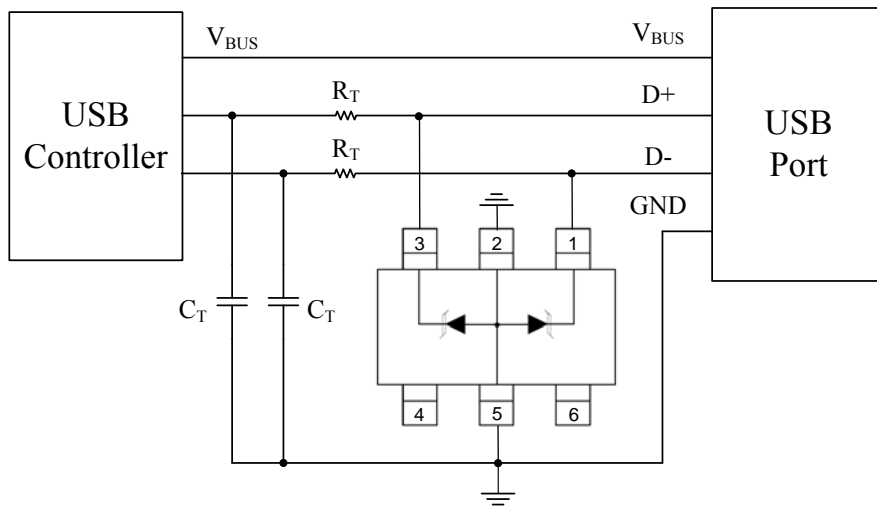
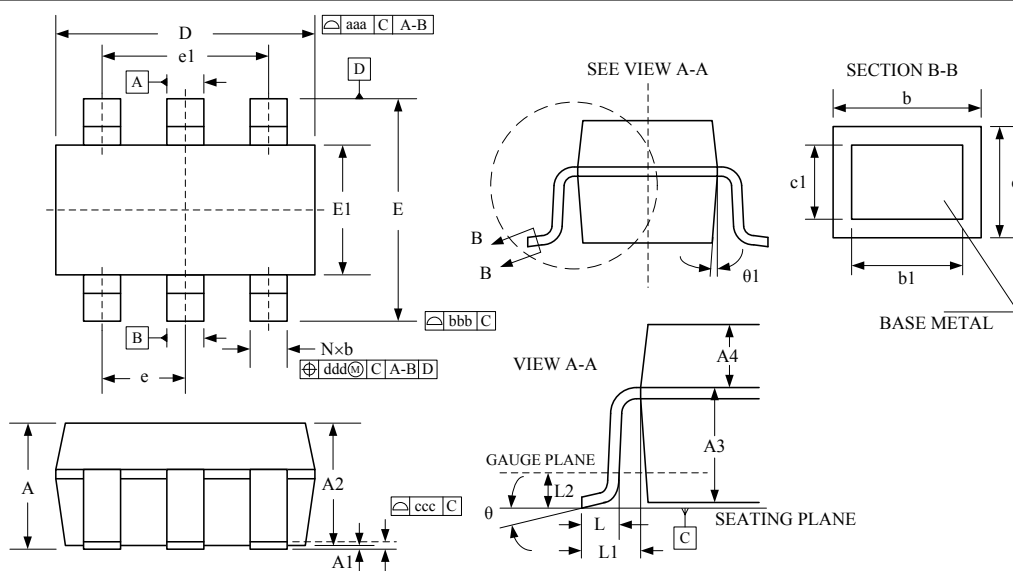

Figure 3 Schematic and Diagram for USB 2.0 Protection using TT0512TLX

Package Outline

□ SOT23-6L package



Package Dimensions (Controlling dimensions are in millimeters)

Symbol	Dimensions (mm)			Dimensions (Inches)		
	Minimum	Typical	Maximum	Minimum	Typical	Maximum
A	—	—	1.450	—	—	0.057
A1	0.000	—	0.150	0.000	—	0.006
A2	0.900	1.200	1.300	0.035	0.047	0.012
A3	0.637	0.787	0.837	0.025	0.031	0.033
A4	0.263	0.413	0.463	0.010	0.016	0.018
b	0.300	—	0.500	0.012	—	0.020
b1	0.300	0.400	0.450	0.012	0.016	0.018
c	0.080	—	0.220	0.003	—	0.009
c1	0.080	0.130	0.200	0.003	0.005	0.008
D	2.90 BSC			0.114 BSC		
e	0.95 BSC			0.037 BSC		
e1	1.90 BSC			0.075 BSC		
E	2.80 BSC			0.110 BSC		
E1	1.60 BSC			0.063 BSC		
L	0.300	0.450	0.600	0.012	0.018	0.024
L1	0.600 REF			0.024 REF		
L2	0.250 BSC			0.010 BSC		
θ	0°	4°	8°	0°	4°	8°
θ1	5°	10°	15°	5°	10°	15°
aaa	0.150			0.006		
bbb	0.200			0.008		
ccc	0.100			0.004		
ddd	0.100			0.004		



Tape and Reel Specification

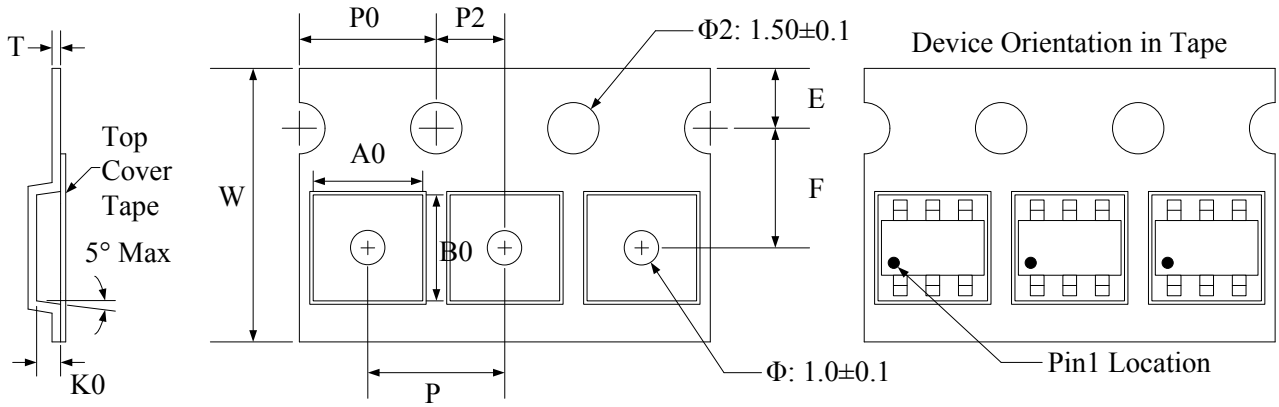

Symbol	W	A0	B0	K0	E	F	P	P0	P2	T
Dimensions (mm)	8.00+0.3 -0.1	3.23±0.05	3.17±0.05	1.37±0.05	1.75±0.1	3.5±0.05	4.0±0.1	4.0±0.1	2.0±0.05	0.25±0.02

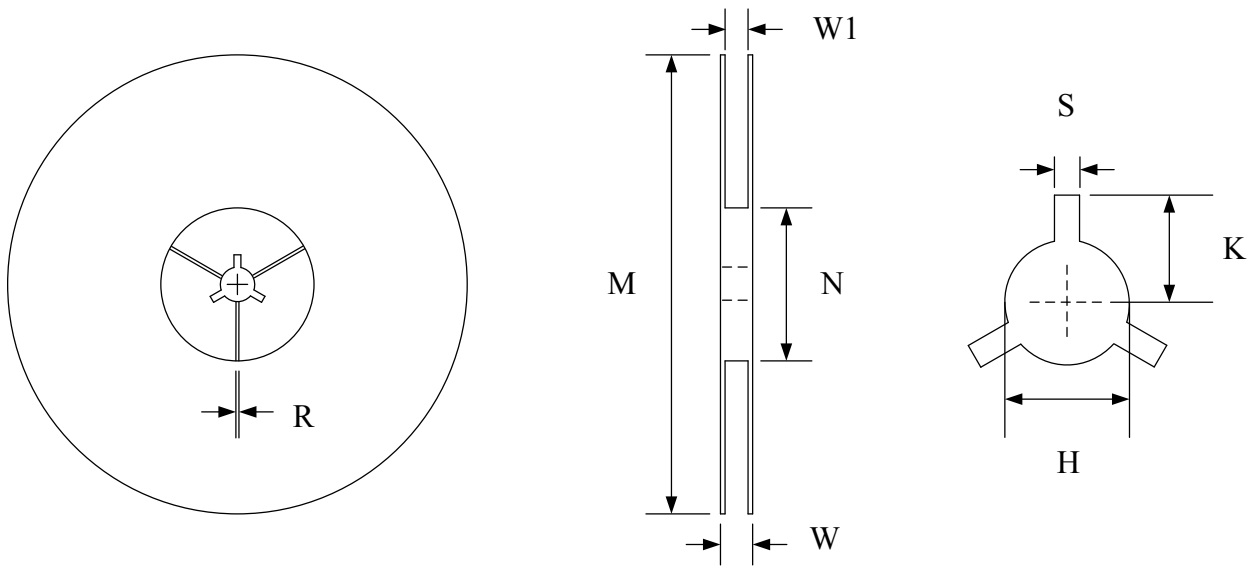

Symbol	Reel Size	M	N	W	W1	H	S	K	R
Dimensions (mm)	Φ178	178.0±1.0	60.0±1.0	11.5±0.5	9.0±0.5	13.0±0.5	2.0±0.1	11.0±0.2	1.0±0.05

Marking Codes

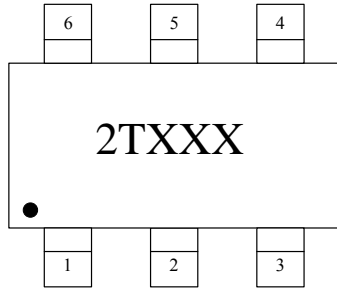

Or

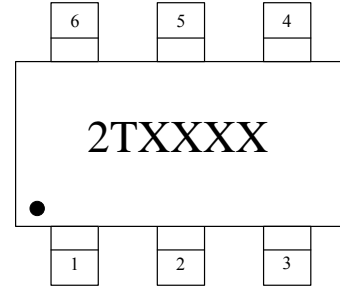

Note:

- (1) “2T” is the part number, fixed.
- (2) “XXX” is internal code.

Note:

- (1) “2T” is the part number, fixed.
- (2) “XXXX” is internal code.

Ordering Information

Part Number	Working Voltage	Quantity Per Reel	Reel Size
TT0512TLX	5V	3,000	7 Inch