

## Features

- ❑ Transient protection for high-speed data lines
  - IEC 61000-4-2 (ESD) ±25kV (Air)
  - ±17kV (Contact)
  - IEC 61000-4-4 (EFT) 40A (5/50 ns)
  - Cable Discharge Event (CDE)
- ❑ Package optimized for high-speed lines
- ❑ Ultra-small package (1.0mm×0.6mm×0.5mm)
- ❑ Protects two data, control or power lines
- ❑ Low capacitance: 0.36pF Typical (I/O-I/O)
- ❑ Low leakage current: 0.1μA @ V<sub>RWM</sub> (Typical)
- ❑ Low clamping voltage
- ❑ Each I/O pin can withstand over 1000 ESD strikes for ±8kV contact discharge

## Description

TT0512TBX is an ultra-low capacitance Transient Voltage Suppressor (TVS) designed to provide electrostatic discharge (ESD) protection for high-speed data interfaces. With typical capacitance of 0.25pF only, TT0512TBX is designed to protect parasitic-sensitive systems against over-voltage and over-current transient events. It complies with IEC 61000-4-2 (ESD), Level 4 (±15kV air, ±8kV contact discharge), IEC 61000-4-4 (electrical fast transient -EFT) (40A, 5/50 ns), very fast charged device model (CDM) ESD and cable discharge event (CDE), etc.

TT0512TBX uses small DFN1006-3L package. Each TT0512TBX device can protect two high-speed datalines. The combined features of low capacitance, small size and high ESD robustness make TT0512TBX ideal for high-speed data ports and high-frequency lines (e.g., USB2.0 & DVI) applications. The low clamping voltage of the TT0512TBX guarantees a minimum stress on the protected IC.

## Applications

- ❑ Serial ATA
- ❑ PCI Express
- ❑ Desktops, Servers and Notebooks
- ❑ Cellular Phones
- ❑ MDDI Ports
- ❑ USB2.0 Power and Data Line Protection
- ❑ Display Ports
- ❑ Digital Visual Interfaces (DVI)

## Mechanical Characteristics

- ❑ DFN1006-3L package
- ❑ Flammability Rating: UL 94V-0
- ❑ Marking: Part number, Date
- ❑ Packaging: Tape and Reel

## Circuit Diagram

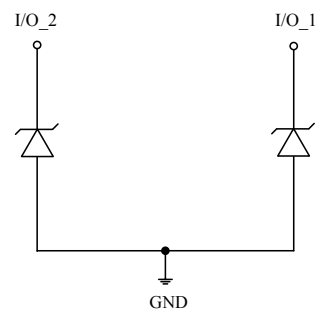

## Pin Configuration

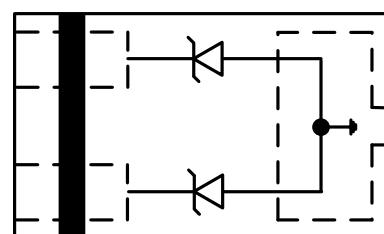

Type A

 DFN1006-3L  
 (Top View)

### Absolute Maximum Rating

Symbol	Parameter	Value	Units
$V_{ESD}$	ESD per IEC 61000-4-2 (Air)	±25	kV
	ESD per IEC 61000-4-2 (Contact)	±17	
$T_{OPT}$	Operating Temperature	-55/+125	°C
$T_{STG}$	Storage Temperature	-55/+150	°C
$I_{PP}$	Peak Pulse Current(8/20us)	3.5	A

### Electrical Characteristics (T = 25°C)

Symbol	Parameter
$V_{RWM}$	Nominal Reverse Working Voltage
$I_R$	Reverse Leakage Current @ $V_{RWM}$
$V_{BR}$	Reverse Breakdown Voltage @ $I_T$
$I_T$	Test Current for Reverse Breakdown
$V_C$	Clamping Voltage @ $I_{PP}$
$I_{PP}$	Peak Pulse Current
$C_{ESD}$	Parasitic Capacitance
$V_R$	Reverse Voltage
f	Small Signal Frequency

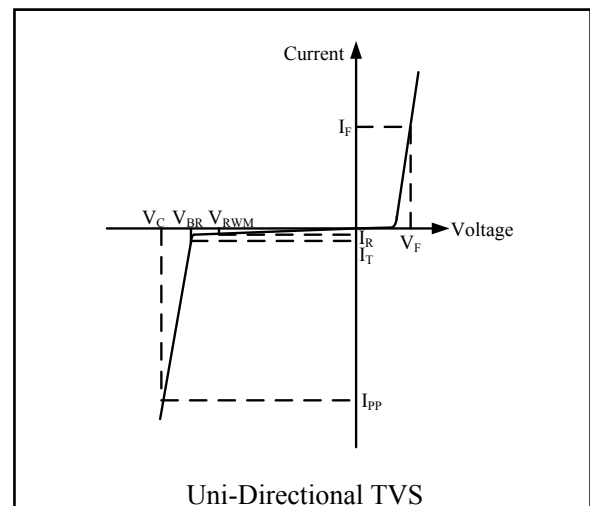

Symbol	Test Condition	Minimum	Typical	Maximum	Units
$V_{RWM}$				5.0	V
$I_R$	$V_{RWM} = 5V, T = 25^\circ C$ Between I/O and GND		0.001	1.0	μA
$V_{BR}$	$I_T = 1mA$ Between I/O and GND	6.0	8.0	10.0	V
$V_C$	$I_{PP} = 1A, t_p = 8/20\mu s$ Between I/O and GND		8.4	12	V
$V_C$	$I_{PP} = 3.5A, t_p = 8/20\mu s$ Between I/O and GND		9.8	12	V
$C_{ESD}$	$V_R = 0V, f = 1MHz$ Between I/O and GND		0.67	0.8	pF
$C_{ESD}$	$V_R = 0V, f = 1MHz$ Between I/O and I/O		0.36	0.5	pF



## Electrostatic Grade Management

Symbol	Parameter	Value	Units
HBM	Human body model	±2500	V
CDM	Charged device model	±1000	V
MM	Machine model	±200	V

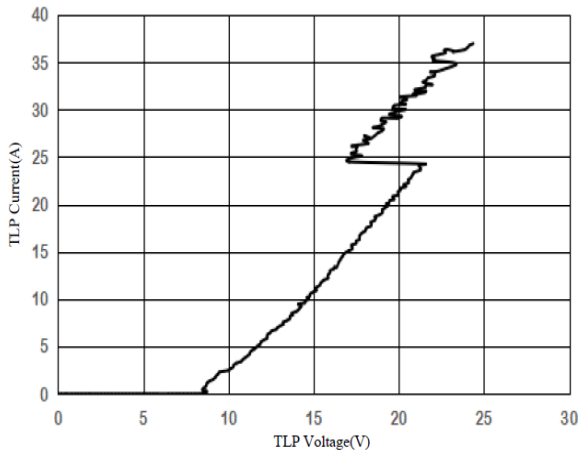
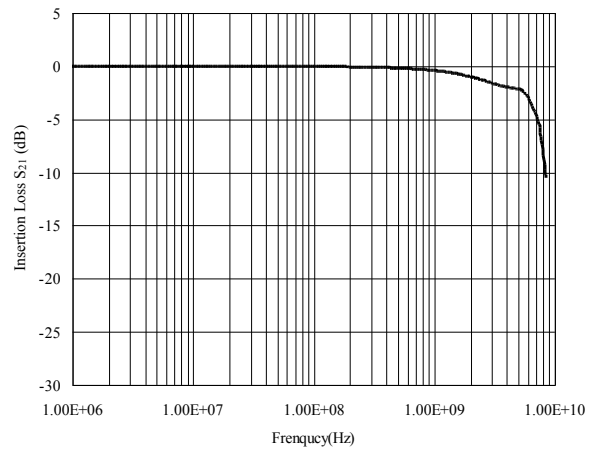
**TLP Measurement of I/O to I/O**

**Insertion Loss S21 of I/O to I/O**

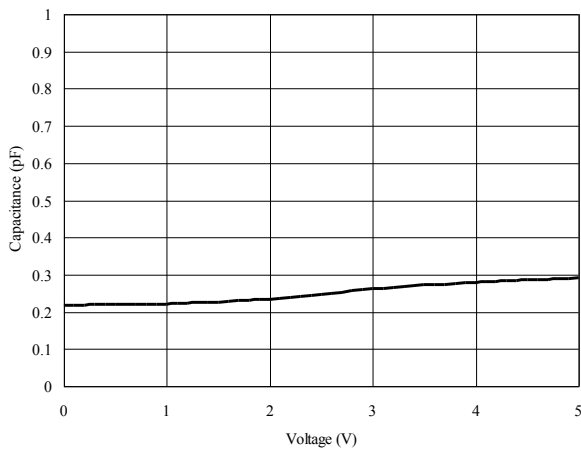
**Capacitance vs. Voltage of I/O to I/O (f = 1MHz)**

Capacitance vs. Reverse Voltage

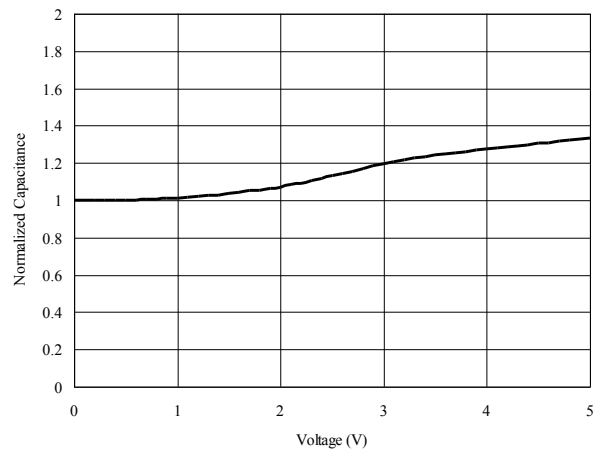
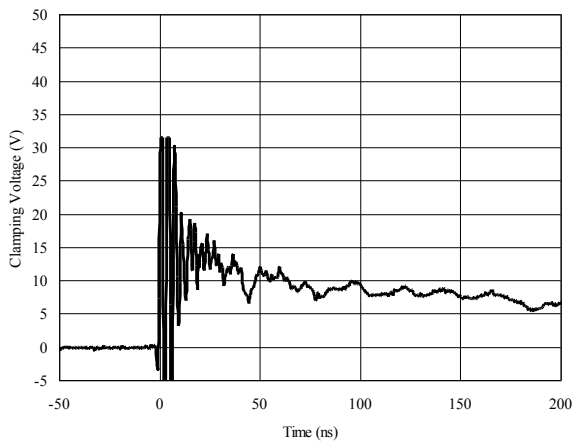
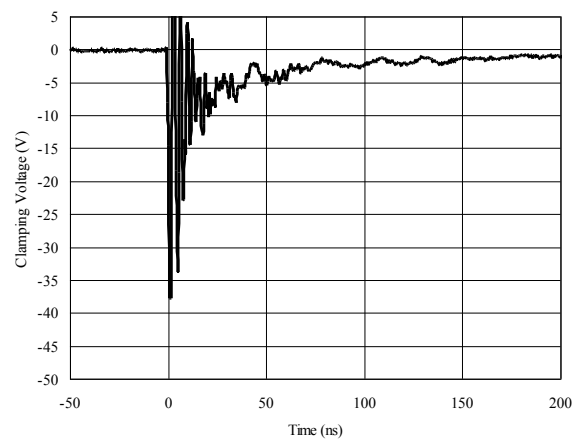

Normalized Capacitance vs. Reverse Voltage

**ESD Clamping of I/O to GND  
(+8kV Contact per IEC 61000-4-2)**

**ESD Clamping of I/O to GND  
(-8kV Contact per IEC 61000-4-2)**

## Package Outline

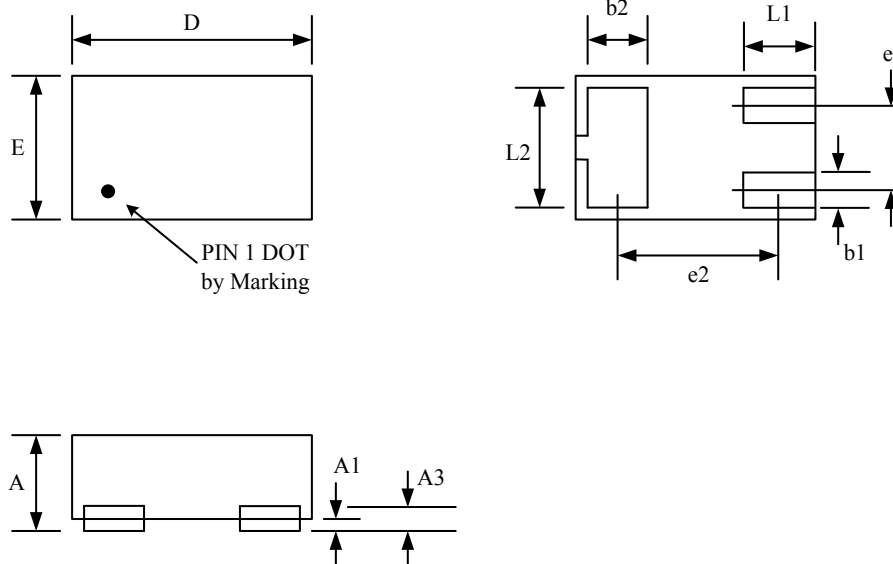
- uDFN-3L package
- 3 leads, very small package



Package Dimensions (Controlling dimensions are in millimeters)

Symbol	Dimensions In Millimeters		Dimensions In Inches	
	Minimum	Maximum	Minimum	Maximum
A	0.400	0.550	0.016	0.022
A1	0.000	0.050	0.000	0.002
A3	0.125 REF		0.005 REF	
D	0.950	1.050	0.037	0.041
E	0.550	0.650	0.022	0.026
b1	0.100	0.200	0.004	0.008
b2	0.200	0.300	0.008	0.012
e1	0.350 BSC		0.014 BSC	
e2	0.675 BSC		0.027 BSC	
L1	0.200	0.400	0.008	0.016
L2	0.400	0.600	0.016	0.024

### Tape and Reel Specification

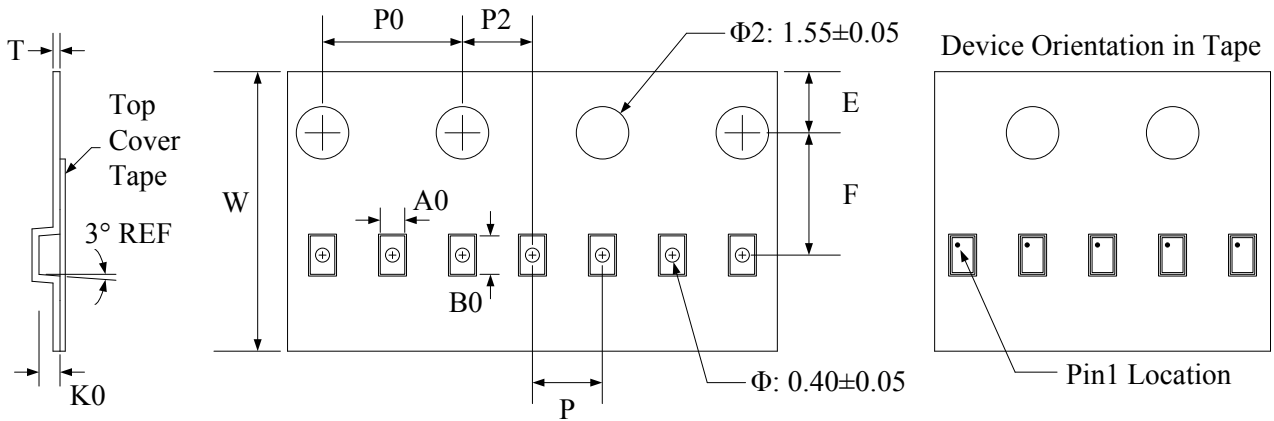

Symbol	W	A0	B0	K0	E	F	P	P0	P2	T
Dimensions (mm)	8.00±0.1	0.7±0.05	1.15±0.05	0.55±0.05	1.75±0.1	3.5±0.05	2.0±0.1	4.0±0.1	2.0±0.05	0.2±0.05

### Marking Codes



### Ordering Information

Part Number	Working Voltage	Quantity Per Reel	Reel Size
TT0512TBX	5V	10,000	7 Inch

#### Note:

- (1) “3” is part number, fixed
- (2) “X” is date code, which is the assembly month in three years, changing as (1~9, 0, A~Z)