



# CD40192 (LX) 4-bit up/down BCD counter

## Product Specification

### Specification Revision History:

Version	Date	Description
2023-04-A1	2023-04	New
2024-04-A2	2024-04	Modify the content



# Contents

<b>1、 General Description.....</b>	<b>3</b>
<b>2、 Block Diagram And Pin Description .....</b>	<b>4</b>
2.1、 Block Diagram .....	4
2.2、 Pin Configurations.....	4
2.3、 Pin Description.....	5
2.4、 Function Table.....	5
<b>3、 Electrical Parameter .....</b>	<b>5</b>
3.1、 Absolute Maximum Ratings.....	5
3.2、 Recommended Operating Conditions.....	6
3.3、 Electrical Characteristics .....	6
3.3.1、 DC Characteristics 1 .....	6
3.3.2、 DC Characteristics 2.....	7
3.3.3、 AC Characteristics 1 .....	7
3.3.4、 AC Characteristics 2.....	9
<b>4、 Testing Circuit .....</b>	<b>11</b>
4.1、 AC Testing Circuit .....	11
4.2、 Test Data .....	11
4.3、 AC Testing Waveforms.....	11
4.4、 Measurement Points .....	12
<b>5、 Package Information .....</b>	<b>13</b>
5.1、 DIP16 .....	13
5.2、 SOP16 .....	14
<b>6、 Statements And Notes .....</b>	<b>15</b>



## 1、General Description

The CD40192 is a 4-bit synchronous up/down BCD counter.

### Features:

- Supply voltage range:3V to 15V
- Temperature range:-40°C to +125°C
- Packaging information: DIP16/SOP16

### Ordering Information:

#### Tube packing specifications:

Part number	Packaging form	Marking code	Tube quantity	Boxed tube quantity	Boxed quantity	Notes
CD40192BE(LX)	DIP16	CD40192BE	25 PCS/tube	40 tube/box	1000 PCS/box	Dimensions of plastic enclosure: 19.0mm×6.4mm Pin spacing:2.54mm

#### Reel packing specifications:

Part number	Packaging form	Marking code	Reel quantity	Boxed reel quantity	Notes
CD40192BM(LX)	SOP16	CD40192BM	4000PCS/reel	8000PCS/box	Dimensions of plastic enclosure: 10.0mm×3.9mm Pin spacing:1.27mm

Note: If the physical information is inconsistent with the ordering information, please refer to the actual product.



## 2、Block Diagram And Pin Description

### 2.1、Block Diagram

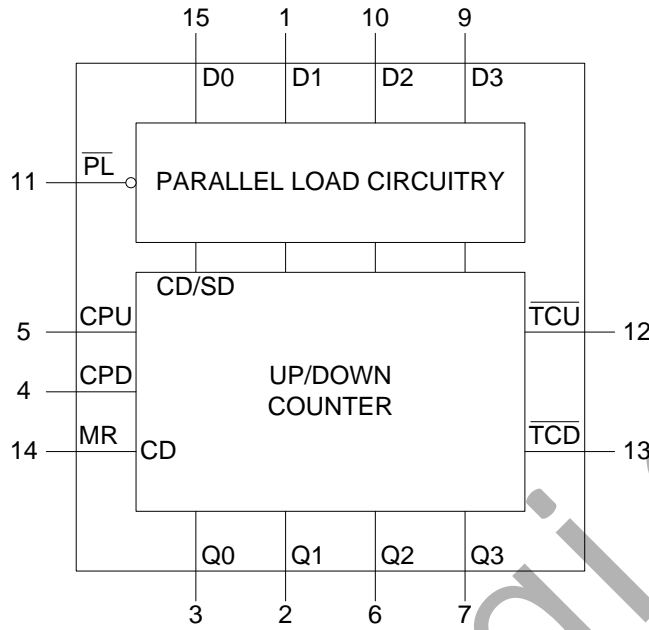
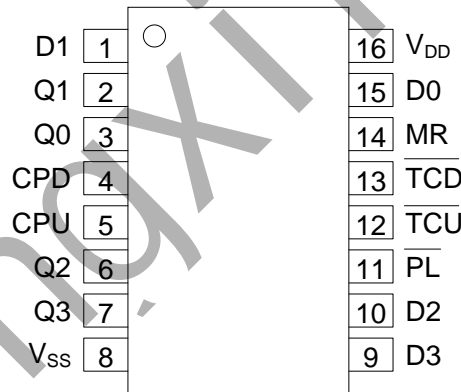

Figure 1. Functional diagram

### 2.2、Pin Configurations







## 2.3、Pin Description

Pin No.	Pin Name	Description
1	D1	parallel data input
2	Q1	buffered counter output
3	Q0	buffered counter output
4	CPD	count-down clock pulse input (LOW-to-HIGH, edge-triggered)
5	CPU	count-up clock pulse input (LOW-to-HIGH, edge-triggered)
6	Q2	buffered counter output
7	Q3	buffered counter output
8	V <sub>SS</sub>	ground supply voltage
9	D3	parallel data input
10	D2	parallel data input
11	$\overline{PL}$	parallel load input (active low)
12	$\overline{TCU}$	buffered terminal count-up (carry) output (active LOW)
13	$\overline{TCD}$	buffered terminal count-down (borrow) output (active LOW)
14	MR	master reset input (asynchronous)
15	D0	parallel data input
16	V <sub>DD</sub>	supply voltage

## 2.4、Function Table

MR	$\overline{PL}$	CPU	CPD	Mode
H	X	X	X	reset(asynchronous)
L	L	X	X	parallel load
L	H	↑	H	count-up
L	H	H	↑	count-down

Note: H=HIGH voltage level; L=LOW voltage level. X=don't care; ↑=positive-going transition;

## 3、Electrical Parameter

### 3.1、Absolute Maximum Ratings

(Voltages are referenced to V<sub>SS</sub> (ground=0V), unless otherwise specified.)

Parameter	Symbol	Conditions	Min.	Max.	Unit
supply voltage	V <sub>DD</sub>	-	-0.5	+18	V
input voltage	V <sub>I</sub>	all inputs	-0.5	V <sub>DD</sub> +0.5	V
DC input current	I <sub>IK</sub>	any one input	-	±10	mA
storage temperature	T <sub>stg</sub>	-	-65	+150	°C
soldering temperature	T <sub>L</sub>	10s	DIP	245	°C
			SOP	260	



## 3.2、Recommended Operating Conditions

Parameter	Symbol	Conditions	Min.	Typ.	Max.	Unit
supply voltage	$V_{DD}$	-	3	-	15	V
ambient temperature	$T_{amb}$	in free air	-40	-	+125	°C

## 3.3、Electrical Characteristics

### 3.3.1、DC Characteristics 1

( $T_{amb}=-40^{\circ}\text{C}$  to  $+85^{\circ}\text{C}$ , voltages are referenced to  $V_{SS}$  (ground=0V), unless otherwise specified.)

Parameter	Symbol	$V_{DD}$	Conditions	Min.	Typ.	Max.	Unit
HIGH-level input voltage	$V_{IH}$	5V	-	3.5	-	-	V
		10V	-	7	-	-	V
		15V	-	11	-	-	V
LOW-level input voltage	$V_{IL}$	5V	-	-	-	1.5	V
		10V	-	-	-	3	V
		15V	-	-	-	4	V
HIGH-level output voltage	$V_{OH}$	5V	$ I_O <1\mu\text{A}$	4.95	-	-	V
		10V	$ I_O <1\mu\text{A}$	9.95	-	-	V
		15V	$ I_O <1\mu\text{A}$	14.95	-	-	V
LOW-level output voltage	$V_{OL}$	5V	$ I_O <1\mu\text{A}$	-	-	0.05	V
		10V	$ I_O <1\mu\text{A}$	-	-	0.05	V
		15V	$ I_O <1\mu\text{A}$	-	-	0.05	V
HIGH-level output current	$I_{OH}$	5V	$V_O=4.6\text{V}$	-	-	-0.34	mA
		5V	$V_O=2.5\text{V}$	-	-	-1.3	mA
		10V	$V_O=9.5\text{V}$	-	-	-0.55	mA
		15V	$V_O=13.5\text{V}$	-	-	-1.65	mA
LOW-level output current	$I_{OL}$	5V	$V_O=0.4\text{V}$	0.34	-	-	mA
		10V	$V_O=0.5\text{V}$	0.46	-	-	mA
		15V	$V_O=1.5\text{V}$	1.4	-	-	mA
input leakage current	$I_I$	15V	$V_I=15\text{V}$ or GND	-	-	$\pm 2$	$\mu\text{A}$
supply current	$I_{DD}$	5V	$V_I=5\text{V}$ or GND; $I_O=0\text{A}$	-	-	7.5	$\mu\text{A}$
		10V	$V_I=10\text{V}$ or GND; $I_O=0\text{A}$	-	-	15	$\mu\text{A}$
		15V	$V_I=15\text{V}$ or GND; $I_O=0\text{A}$	-	-	30	$\mu\text{A}$



### 3.3.2、DC Characteristics 2

( $T_{amb}=-40^{\circ}\text{C}$  to  $+125^{\circ}\text{C}$ , voltages are referenced to  $V_{SS}$  (ground=0V), unless otherwise specified.)

Parameter	Symbol	$V_{DD}$	Conditions	Min.	Typ.	Max.	Unit
HIGH-level input voltage	$V_{IH}$	5V	-	3.5	-	-	V
		10V	-	7	-	-	V
		15V	-	11	-	-	V
LOW-level input voltage	$V_{IL}$	5V	-	-	-	1.5	V
		10V	-	-	-	3	V
		15V	-	-	-	4	V
HIGH-level output voltage	$V_{OH}$	5V	$ I_O <1\mu\text{A}$	4.95	-	-	V
		10V	$ I_O <1\mu\text{A}$	9.95	-	-	V
		15V	$ I_O <1\mu\text{A}$	14.95	-	-	V
LOW-level output voltage	$V_{OL}$	5V	$ I_O <1\mu\text{A}$	-	-	0.05	V
		10V	$ I_O <1\mu\text{A}$	-	-	0.05	V
		15V	$ I_O <1\mu\text{A}$	-	-	0.05	V
HIGH-level output current	$I_{OH}$	5V	$V_O=4.6\text{V}$	-	-	-0.3	mA
		5V	$V_O=2.5\text{V}$	-	-	-1.15	mA
		10V	$V_O=9.5\text{V}$	-	-	-0.45	mA
		15V	$V_O=13.5\text{V}$	-	-	-1.4	mA
LOW-level output current	$I_{OL}$	5V	$V_O=0.4\text{V}$	0.29	-	-	mA
		10V	$V_O=0.5\text{V}$	0.38	-	-	mA
		15V	$V_O=1.5\text{V}$	1.2	-	-	mA
input leakage current	$I_I$	15V	$V_I=15\text{V}$ or GND	-	-	$\pm 4$	$\mu\text{A}$
supply current	$I_{DD}$	5V	$V_I=5\text{V}$ or GND; $I_O=0\text{A}$	-	-	7.5	$\mu\text{A}$
		10V	$V_I=10\text{V}$ or GND; $I_O=0\text{A}$	-	-	15	$\mu\text{A}$
		15V	$V_I=15\text{V}$ or GND; $I_O=0\text{A}$	-	-	30	$\mu\text{A}$

### 3.3.3、AC Characteristics 1

( $T_{amb}=-40^{\circ}\text{C}$  to  $+85^{\circ}\text{C}$ ,  $V_{SS}=0\text{V}$ , unless otherwise specified.)

Parameter	Symbol	$V_{DD}$	Conditions	Min.	Typ.	Max.	Unit
HIGH to LOW propagation delay time	$t_{PHL}$	5V	CPU to Qn See Figure 4	-	210	415	ns
		10V		-	85	165	ns
		15V		-	60	120	ns
		5V	CPD to Qn See Figure 4	-	210	425	ns
		10V		-	85	170	ns
		15V		-	60	125	ns
		5V	CPU to $\overline{\text{TCU}}$	-	125	250	ns
		10V		-	50	100	ns
		15V		-	35	70	ns
		5V	CPD to $\overline{\text{TCD}}$	-	140	280	ns
		10V		-	55	110	ns
		15V		-	40	80	ns
		5V	MR to Qn	-	195	390	ns
		10V		-	80	160	ns
		15V		-	60	120	ns



		5V	MR to $\overline{\text{TCD}}$	-	365	730	ns		
		10V		-	130	265	ns		
		15V		-	100	205	ns		
				5V	$\overline{\text{PL}}$ to Qn	-	185	360	ns
				10V		-	75	150	ns
				15V		-	55	110	ns
LOW to HIGH propagation delay time	$t_{\text{PLH}}$	5V	CPU to Qn See Figure 4	-	170	340	ns		
		10V		-	70	140	ns		
		15V		-	50	100	ns		
				5V	CPD to Qn See Figure 5	-	170	340	ns
				10V		-	70	140	ns
				15V		-	50	100	ns
				5V	CPU to $\overline{\text{TCU}}$	-	95	185	ns
				10V		-	40	80	ns
				15V		-	30	60	ns
				5V	CPD to $\overline{\text{TCD}}$	-	100	195	ns
				10V		-	40	85	ns
				15V		-	30	65	ns
				5V	MR to $\overline{\text{TCU}}$	-	145	285	ns
				10V		-	60	115	ns
				15V		-	45	90	ns
				5V	$\overline{\text{PL}}$ to Qn	-	145	290	ns
				10V		-	60	120	ns
				15V		-	45	90	ns
transition time	$t_{\text{THL}}, t_{\text{TLH}}$	5V	See Figure 4	-	60	120	ns		
		10V		-	30	60	ns		
		15V		-	20	40	ns		
set-up time	$t_{\text{su}}$	5V	Dn to $\overline{\text{PL}}$	160	80	-	ns		
		10V		60	30	-	ns		
		15V		50	25	-	ns		
hold time	$t_{\text{hold}}$	5V	Dn to $\overline{\text{PL}}$	+10	-70	-	ns		
		10V		+5	-25	-	ns		
		15V		+5	-20	-	ns		
pulse width	$t_{\text{w}}$	5V	CPU or CPD LOW; minimum width	150	75	-	ns		
		10V		50	25	-	ns		
		15V		35	20	-	ns		
				5V	MR input HIGH minimum width	180	90	-	ns
				10V		70	35	-	ns
				15V		60	30	-	ns
				5V	$\overline{\text{PL}}$ input LOW minimum width	120	60	-	ns
				10V		45	20	-	ns
				15V		30	15	-	ns
recovery time	$t_{\text{rec}}$	5V	MR input	125	65	-	ns		
		10V		70	35	-	ns		
		15V		50	25	-	ns		
		5V	$\overline{\text{PL}}$ input	90	45	-	ns		



		10V		35	15	-	ns
		15V		25	10	-	ns
		5V		2.5	5	-	MHZ
maximum clock pulse frequency	fmax	10V	-	7	14	-	MHZ
		15V	-	9	18	-	MHZ

### 3.3.4、AC Characteristics 2

( $T_{amb}=-40^{\circ}\text{C}$  to  $+125^{\circ}\text{C}$ ,  $V_{SS}=0\text{V}$ , unless otherwise specified.)

Parameter	Symbol	V <sub>DD</sub>	Conditions	Min.	Typ.	Max.	Unit
HIGH to LOW propagation delay time	t <sub>PHL</sub>	5V	CPU to Qn See Figure 4	-	-	498	ns
		10V		-	-	198	ns
		15V		-	-	144	ns
		5V	CPD to Qn See Figure 4	-	-	510	ns
		10V		-	-	204	ns
		15V		-	-	150	ns
		5V	CPU to $\overline{\text{TCU}}$	-	-	300	ns
		10V		-	-	120	ns
		15V		-	-	84	ns
		5V	CPD to $\overline{\text{TCD}}$	-	-	336	ns
		10V		-	-	132	ns
		15V		-	-	96	ns
		5V	MR to Qn	-	-	468	ns
		10V		-	-	192	ns
		15V		-	-	144	ns
		5V	MR to $\overline{\text{TCD}}$	-	-	876	ns
		10V		-	-	318	ns
		15V		-	-	246	ns
5V	$\overline{\text{PL}}$ to Qn	-	-	432	ns		
10V		-	-	180	ns		
15V		-	-	132	ns		
LOW to HIGH propagation delay time	t <sub>PLH</sub>	5V	CPU to Qn See Figure 4	-	-	408	ns
		10V		-	-	168	ns
		15V		-	-	120	ns
		5V	CPD to Qn See Figure 5	-	-	408	ns
		10V		-	-	168	ns
		15V		-	-	120	ns
		5V	CPU to $\overline{\text{TCU}}$	-	-	222	ns
		10V		-	-	96	ns
		15V		-	-	72	ns
		5V	CPD to $\overline{\text{TCD}}$	-	-	234	ns
		10V		-	-	102	ns
		15V		-	-	78	ns
		5V	MR to $\overline{\text{TCU}}$	-	-	342	ns
		10V		-	-	138	ns
		15V		-	-	108	ns



		5V	$\overline{\text{PL}}$ to Qn	-	-	348	ns
		10V		-	-	144	ns
		15V		-	-	108	ns
transition time	$t_{\text{THL}}, t_{\text{TLH}}$	5V	See Figure 4	-	-	144	ns
		10V		-	-	72	ns
		15V		-	-	48	ns
set-up time	$t_{\text{su}}$	5V	Dn to $\overline{\text{PL}}$	192	-	-	ns
		10V		72	-	-	ns
		15V		60	-	-	ns
hold time	$t_{\text{hold}}$	5V	Dn to $\overline{\text{PL}}$	+12	-	-	ns
		10V		+6	-	-	ns
		15V		+6	-	-	ns
pulse width	$t_{\text{w}}$	5V	CPU or CPD LOW; minimum width	180	-	-	ns
		10V		60	-	-	ns
		15V		42	-	-	ns
		5V	MR input HIGH minimum width	216	-	-	ns
		10V		84	-	-	ns
		15V		72	-	-	ns
		5V	$\overline{\text{PL}}$ input LOW minimum width	144	-	-	ns
		10V		54	-	-	ns
		15V		36	-	-	ns
recovery time	$t_{\text{rec}}$	5V	MR input	150	-	-	ns
		10V		84	-	-	ns
		15V		60	-	-	ns
		5V	$\overline{\text{PL}}$ input	108	-	-	ns
		10V		42	-	-	ns
		15V		30	-	-	ns
maximum clock pulse frequency	$f_{\text{max}}$	5V	-	2	-	-	MHZ
		10V	-	6	-	-	MHZ
		15V	-	7.5	-	-	MHZ



## 4、Testing Circuit

### 4.1、AC Testing Circuit

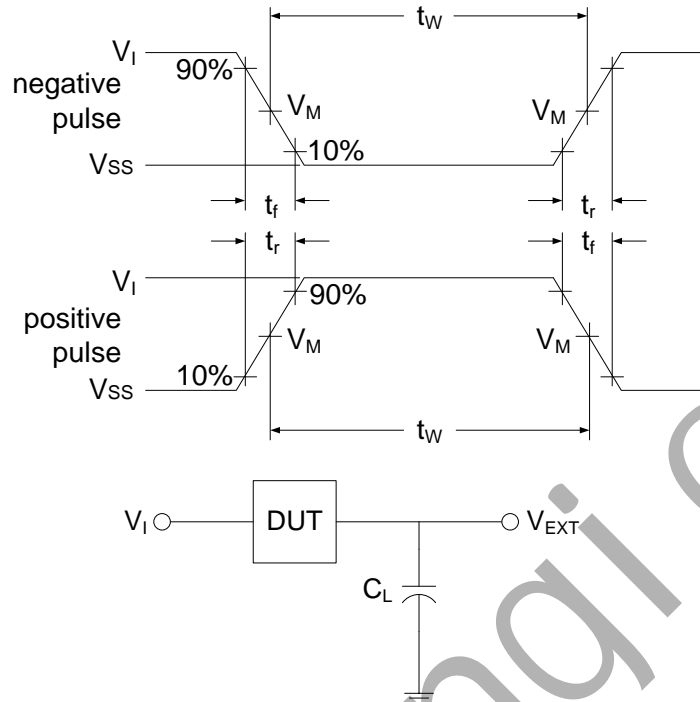

Figure 3. Load circuit

$C_L$  includes probe and jig capacitance.

### 4.2、Test Data

Supply voltage	Input		Load	$V_{EXT}$		
$V_{DD}$	$V_I$	$t_r = t_f$	$C_L$	$t_{PLH}/t_{PHL}$	$t_{PLZ}/t_{PZL}$	$t_{PHZ}/t_{PZH}$
5V to 15V	$V_{DD}$	$\leq 20\text{ns}$	50pF	Open	$V_{DD}$	$V_{SS}$

### 4.3、AC Testing Waveforms

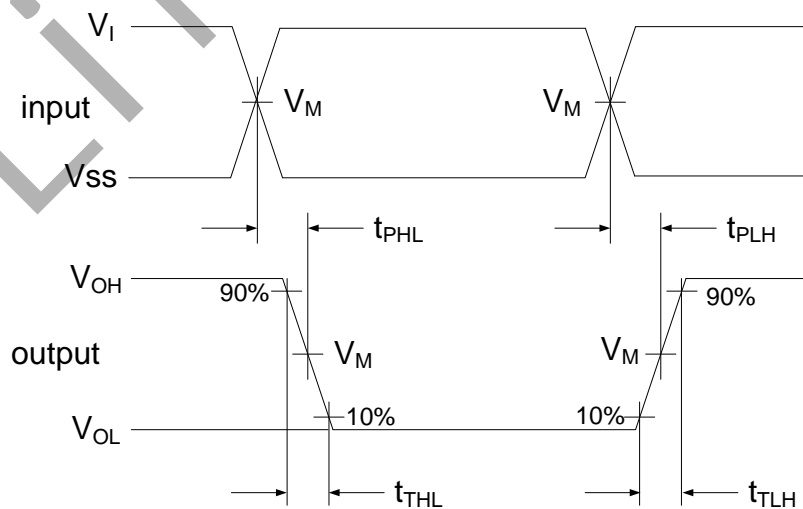

Figure 4. Propagation delay, output transition time

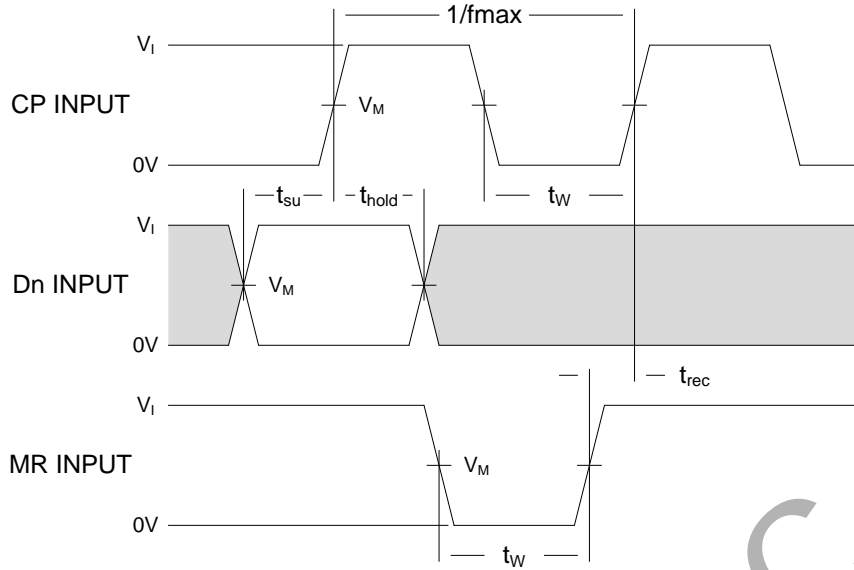

Figure 5. Minimum pulse widths for CP and MR, MR to CP recovery time, and set-up and hold time for Dn to CP

#### 4.4、Measurement Points

Supply voltage	Input	Output		
V <sub>DD</sub>	V <sub>M</sub>	V <sub>M</sub>	V <sub>X</sub>	V <sub>Y</sub>
5V to 15V	0.5×V <sub>DD</sub>	0.5×V <sub>DD</sub>	0.1×V <sub>DD</sub>	0.9×V <sub>DD</sub>





## 5、Package Information

### 5.1、DIP16

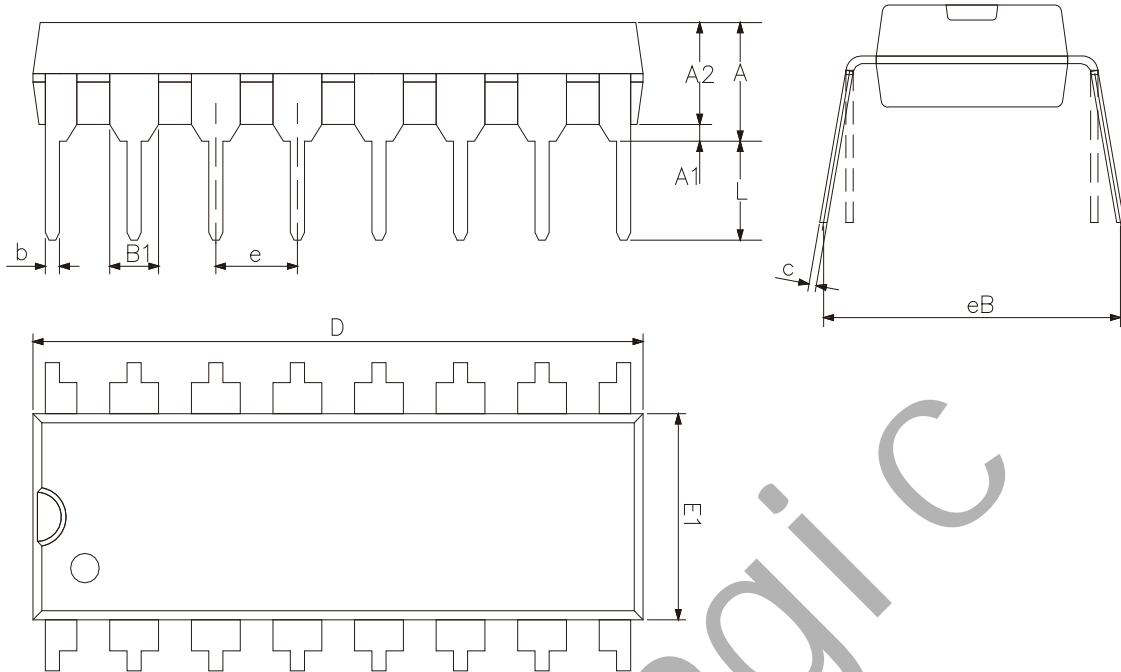

2023/12/A	Dimensions In Millimeters	
Symbol	Min	Max
A2	3.20	3.60
A1	0.51	—
A	3.60	5.33
L	3.00	—
b	0.36	0.56
B1	1.52	
D	18.80	19.94
E1	6.20	6.60
e	2.54	
c	0.20	0.36
eB	7.62	9.30



## 5.2、SOP16

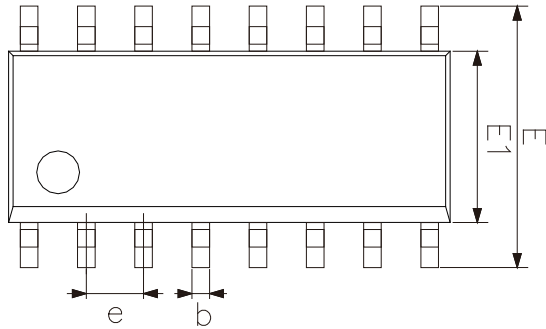
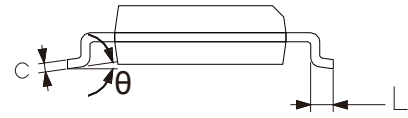
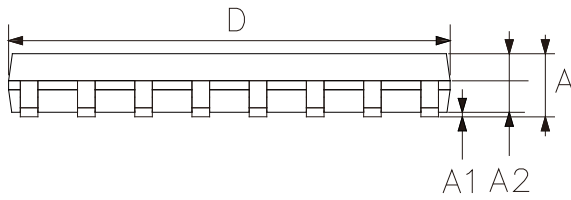

2023/12/A Symbol	Dimensions In Millimeters	
	Min.	Max.
A	1.35	1.80
A1	0.10	0.25
A2	1.25	1.55
b	0.33	0.51
c	0.19	0.25
D	9.50	10.10
E	5.80	6.30
E1	3.70	4.10
e	1.27	
L	0.35	0.89
θ	0°	8°



---

## 6、Statements And Notes

Recommended carefully reading this information before the use of this product;

The information in this document are subject to change without notice;

This information is using to the reference only, the company is not responsible for any loss;

The company is not responsible for the any infringement of the third party patents or other rights of the responsibility.

Lingxingic