



Under Development	
Mass production	●

RoHS

# Specification

## 规格书

Client Name :

客户名称 : \_\_\_\_\_

Client P/N :

客户品号 : \_\_\_\_\_

Product P/N :

**HL-LM002H384W-7B3C12(Ra5)**

产品型号 : \_\_\_\_\_

Sending Date:

送样日期 : \_\_\_\_\_

Client approval 客户审核		Hongli ZhiHui approval 鸿利智汇审核		
Approval 核准	Audit 确认	Approval 核准	Audit 确认	Confirmation 制作
				尹键
<input type="checkbox"/> Qualified 接受	<input type="checkbox"/> Disqualified 不接受	DATE: 日期 :		

Adr : No. 1, Xianke Yi Road, Huadong Town, Huadu District, Guangzhou, China

地址 : 中国广州市花都区花东镇先科一路1号

Tel/电话 : 020-37705135

Fax/传真 : 020-37705136

Web/网址 : www.honglitrionic.com

注:1. 此规格书以中英文方式书写,若有冲突以中文版本为准文本.

2. 此规格书的最终解释权归鸿利智汇集团股份有限公司

3. 此规格书的有效期限为两年,自盖章或签字之日起计算,期满时双方可以续签协议,但应采用书面形式



Under Development	
Mass production	●

## 1.Part code 产品型号命名原则

LM 002 H384 W - 7 B3 C12 (Ra5)

① ② ③ ④ ⑤ ⑥ ⑦ ⑧

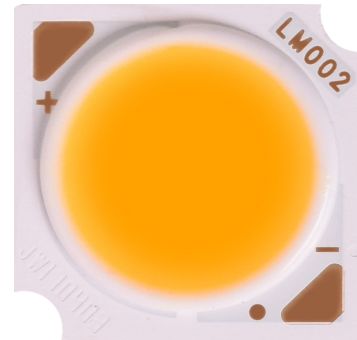

- ① Product line code 产品系列代码
- ② Product code base plate 产品基板代码
- ③ Chip code 芯片代码
- ④ Emitting light colors 发光颜色
- ⑤ Recommended Use power  
建议使用功率
- ⑥ The number of parallel Circuit 并联电路数
- ⑦ The number of series Circuit 串联电路数
- ⑧ CRI 显色指数

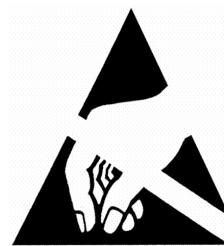

**ATTENTION**注意  
OBSERVE PRECAUTIONS  
FOR HANDLING  
ELECTROSTATIC  
DISCHARGE  
SENSITIVE  
DEVICES  
请勿裸手接触器件

## 2.Features 特点

- Dimension 13.5mm×13.5mm×1.5mm  
尺寸13.5mm×13.5mm×1.5mm
- CRI: Ra 95 显色指数：95
- Wide viewing angle : 120° 发光角度：120°
- RoHS compliant (ROHS标准)
- sulphation corrosion resistance 抗硫化
- Manual Soldering 手工焊接

## 3.Applications 应用

- Down light 筒灯
- Spot light 射灯

## 4.Package Dimensions 封装尺寸

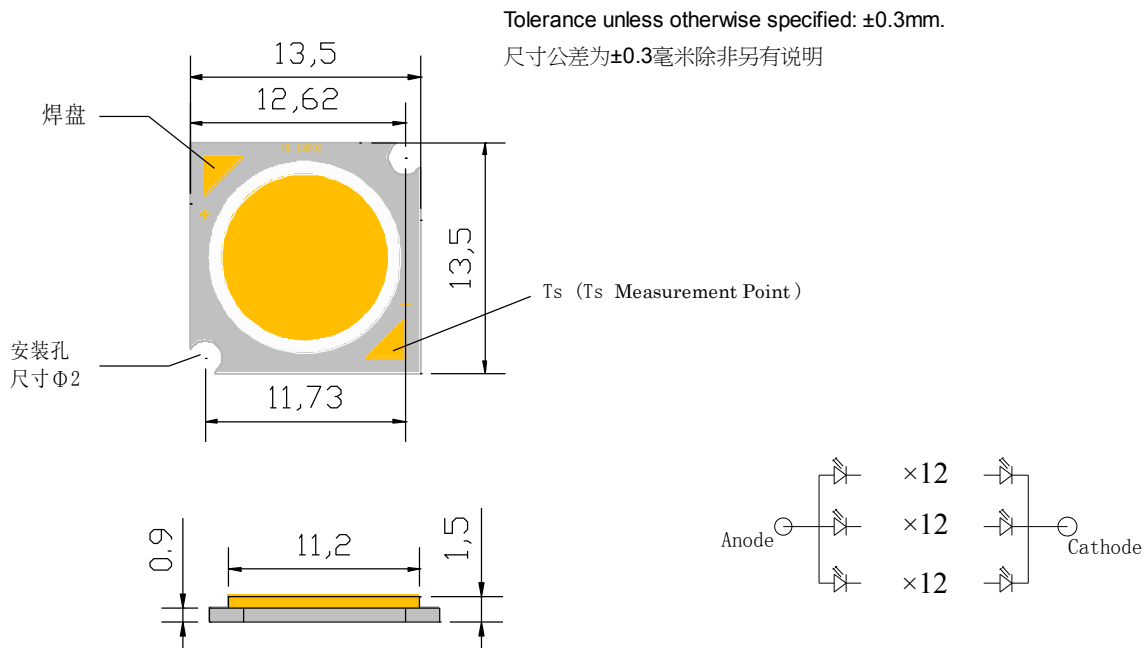

## 5.Performance 性能

### (1) Absolute Maximum Ratings 绝对最大额定值

Parameter参数	Symbol符号	Min.	Typ.	Max.	Units单位
Input power range 输入功率范围	Pi	—	10.8	—	W
operating current range 工作电流范围	IF	—	300	—	mA
Parameter参数	Symbol符号	Rating Value值			Units单位
Junction Temperature结温	Tj	115			$^{\circ}\text{C}$
Operating Temperature Range工作温度	Top	-35 $^{\circ}\text{C}$ To +80 $^{\circ}\text{C}$			
Storage Temperature Range储藏温度	Tstg	-40 $^{\circ}\text{C}$ To +100 $^{\circ}\text{C}$			
Lead Soldering Temperature*引线焊接温度	T <sub>SOL</sub>	Max. 350 $^{\circ}\text{C}$ for 5sec Max.			

Notes for Table:

1.The temperature of Aluminum PCB do not exceed 85 $^{\circ}\text{C}$ . If the input power reach 80% max Pi, the temperature of Aluminum PCB should be control below 75 $^{\circ}\text{C}$

基板负极引线温度不能超过85 $^{\circ}\text{C}$ .如果输入功率达到最大输入功率的80%以上,基板负极引线温度应控制在75 $^{\circ}\text{C}$ 以内.

2.When hand soldering, keep the temperature of iron below less 350 $^{\circ}\text{C}$  less than 5seconds

当手工焊接时,烙铁的温度必须小于350 $^{\circ}\text{C}$ ,时间不能超过5秒



Under Development	
Mass production	●

(2) Electro-Optical Characteristics

at Tc=25°C

光电特性 Tc=25°C

Parameter参数	Symbol符号	Condition 条件	Min.	Typ.	Max.	LM/W (typ)	Unit 单位
Forward Voltage 正向电压	VF	IF=300mA	34	36	40	—	V
Luminous Flux 光通量	Φv	TC=2700K	850	920	1030	105	lm
		TC=3000K	980	1040	1150	95	
		TC=3500K	1080	1140	1240	108	
		TC=4000K	1030	1100	1210	102	
		TC=4500K	1030	1100	1210	102	
		TC=5000K	1030	1100	1210	102	
		TC=5700K	—	—	—	—	
		TC=6000±300K	940	1000	1100	93	
TC=6500K	—	—	—	—			
CRI 显色指数	Ra	IF=300mA	95	—	—	—	—
Thermal Resistance 热阻	R (j-c)	IF=300mA	—	4.4	—	—	°C/W

6. Product bins 产品分级

Chromaticity bins

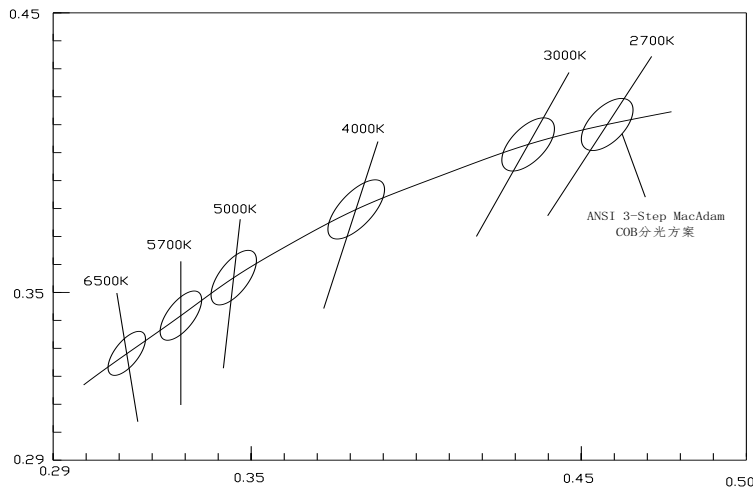

Center TC	2725K	3045K	3985K	5028K	5665K	6530K
X, Y	0.4578, 0.4101	0.4338, 0.403	0.3818, 0.3797	0.3447, 0.3553	0.329, 0.3417	0.3123, 0.3282

Notes for Table

\*1. Color bins are defined at IF=300mA operation. If use different forward current, it will cause the change of chromaticity and forward voltage.

该产品通过瞬态300mA 点亮，分光分色。若使用不同电流，会引起色温及电压的变化

\*2. The tolerance of measurement at our tester is VF+/-3% , Φv+/-10% and Ra+/-2.

测试仪测量的公差在电压±3%，流明±10% 和显指±2。

3. Tolerance of ±0.005 on x,y coordinates.

色坐标的测量误差允许在±0.005

4. Color region stay within MacAdam "3-step" ellipse from the chromaticity center. but does not contain the color temperature 6000±300K. The chromaticity center refers to ANSI C78.377-2008.

色域可控制在色温中心坐标的3阶麦克亚当椭圆之内，但不包括色温6000±300K，色温分bin参考ANSI C78.377-2008。



Under Development	
Mass production	●

## 7.Characteristics特性

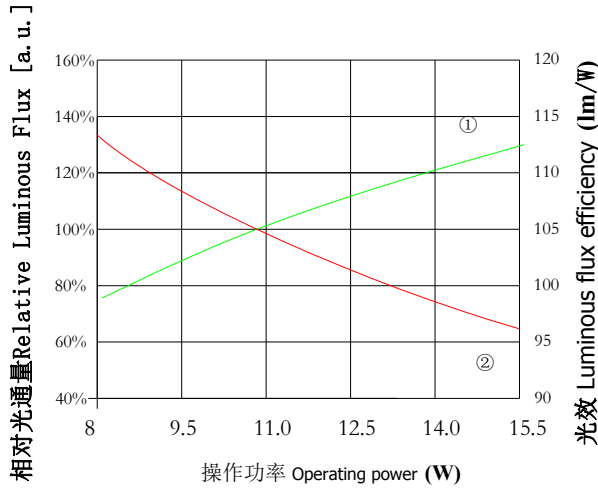

① — 操作功率对应相对光通量 ② — 操作功率对应光效

Forward Voltage vs. Forward Current  
正向电压与正向电流曲线图

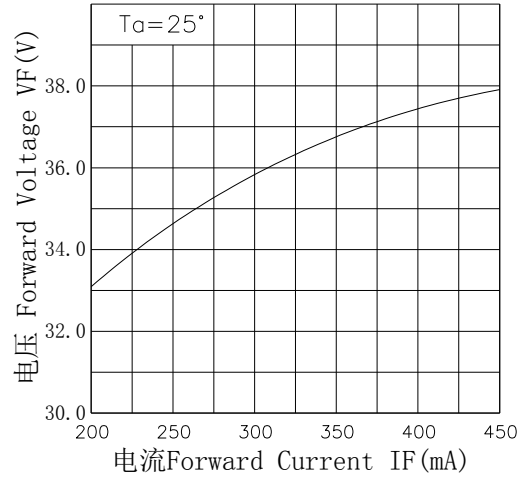

Case Temperature vs. Forward Voltage  
结点温度与正向电压曲线图 IF=300mA

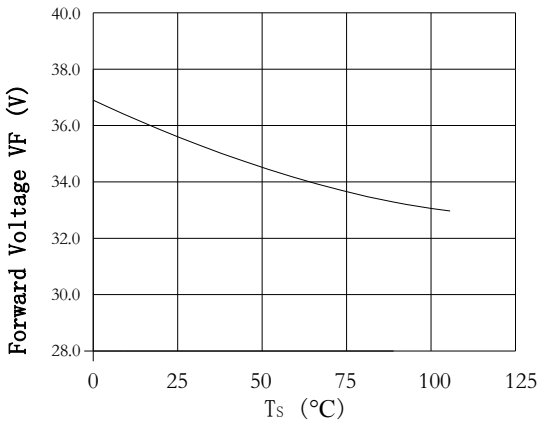

Case Temperature vs. Relative Luminous Flux  
结点温度与相对流明曲线图 IF=300mA

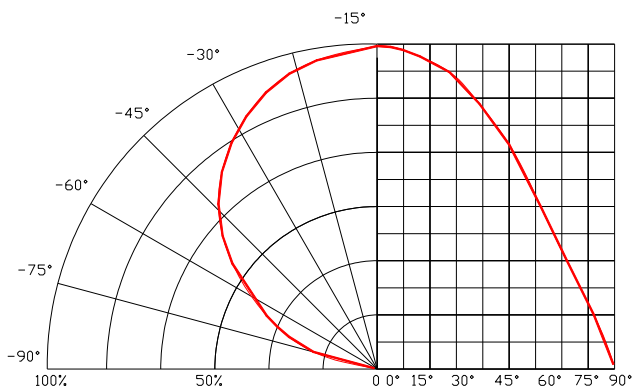
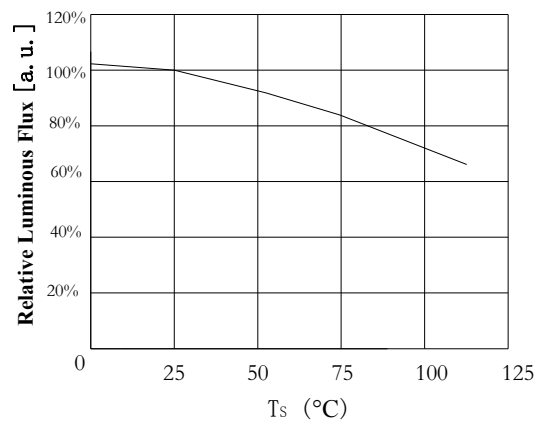

Wavelength Characteristics Ta=25°C  
相对光谱分布曲线图

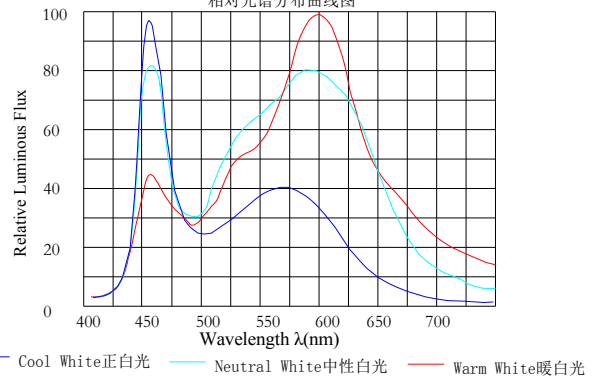



Under Development	
Mass production	●

## 8.Packing Specifications 包装规格

 <b>HONGLITRONIC</b> 鸿利光电		
TYPE:		QTY:
VF:	IF:	ΦV:
TC:	X/Y:	
SDCM<	Ra>	
DATE:		LOT.NO:

Label on ESD shielding 静电袋上标签

 <b>HONGLITRONIC</b> (Product Identity Card) 鸿利光电		成品标示卡 
品名 (Description):		
产品型号 (Type):		
发光颜色 (Color):		
数量 (QTY):		
生产批号 (LOT NO):		
出货日期 (Date):		
操作员 (Operator):		

Label on box 外箱标签

ΦV: Luminous Flux rank 光通量档次范围

VF: Forward voltage rank 正向电压档次范围

TC: Color temperature 色温

SDCM: 相对色容差

### ■ Packing figure 包装图

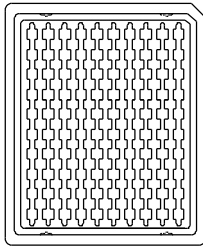

Tray: 50pcs

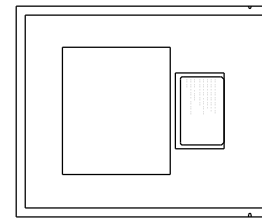
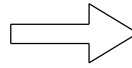

6Tray/ESD Shilding Bag:300pcs

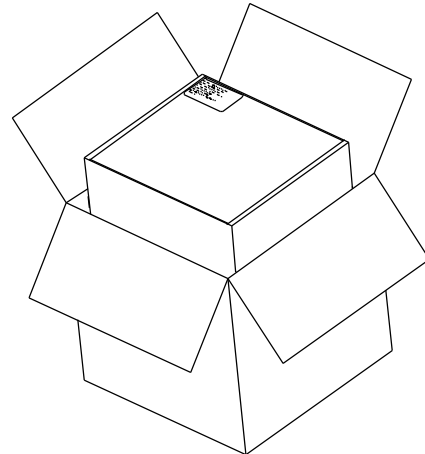
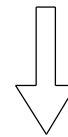

2ESD Shilding Bag/Inner Box:600pcs

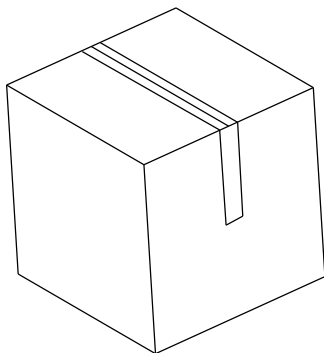
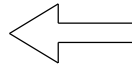

4Inner Box/Outer Box:2400pcs



Under Development	
Mass production	●

## Precaution for use (防护措施)

### 1. Storage 储存

To avoid moisture, we recommend storage conditions for the unopened LED +5 ~ +30 °C, relative humidity <60%. LED should be used within 168 Hrs. of opening the package. Please make sure to dehumidify and vacuum pack the remaining/ unused LED. Dehumidifying condition: +120 ° C ± 5 ° C, 04 Hrs. Effective age for the sealed led is one year. 为避免受潮的影响，我司建议产品在未开包装前储存条件为 5-30° C，相对湿度小于 60%。已开包装的 LED 光源请在 168H 内使用安装完毕，如未用完之产品，请进行除湿并抽真空后密封保存。除湿条件：120° C ± 5° C，4H。产品密封保存有效使用期为一年。

### 2. The soldering precautions 组装注意事项：

Soldering conditions: Reflow soldering is not recommended for this LED. If hand soldering, set soldering iron temperature at 350°C and soldering time not More than 5 seconds, after the first soldering, make sure the substrate surface temperature returns to ambient temperature before a second soldering. Please make sure when soldering, there is no external force on the soldering surface and silicon batardeau (such as pressure, friction or sharp metal nails, etc.), to avoid gold wire deformation or damage and other abnormalities. If beyond recommended conditions, we cannot guarantee the LED stability, please do the risk assessment first.

During assembly, please ensure that a good quality thermal paste is applied and distributed evenly over the surface. While using thermal pad (Heat Sink), make sure LED is firmly tightened and there is no gap between surfaces. In such heat-media products, through a pressure test of at least 500 volts. 焊接条件：此产品不推荐使用回流焊接的作业方式，手工焊接烙铁温度设定 350° C，焊接时间不可超过 5 秒，第一焊点焊接后请确保基板表面温度恢复到环境温度，方可进行第二次的焊接。焊接时请注意不可有外力作用于胶体表面及外圈的围堰胶上（如压力，摩擦或锋利金属钉等），以免造成金线变形或断线等异常；如果超出此使用条件，鸿利智汇将不能保证产品的稳定性，如需使用超出的操作条件，请务必进行风险评。

为确保在组装时降低接触热阻，请注意导热膏涂布均匀且分布面积合理，不可出现导热膏太少或涂抹高低不平等现象。如使用导热胶垫时，请确保螺丝安装后基板与导热胶垫的完全接触，不可存在中空现象。产品在此类耐热介质下，能通过至少500伏的耐压测试。

### 3. Anti-Static Measures 防静电措施：

Please take adequate measures to prevent electrostatic generation, such as wearing electrostatic ring or anti-static fingerstall etc; any relative products like plant equipment, machinery, carrier and transportation units shall be connected to discharging unit/ ground. The ESD sensitivity of this product is > 1000V(HBM), after assembly the final lamp, please make sure to discharge Static Electricity by proper ESD equipment. 请采取足够的措施来防止静电产生，比如带静电环或防静电手指套等；每个制造厂关于产品（工厂、设备、机器、载波机和运输单位）应当连接到底面，请避免产品电气带电；本产品的防静电敏感度超过1000V (HBM)，装配后的最终灯具产品（S）建议检查是否损坏LED（漏电现象）。



#### 4. Temperature Control温度控制：

Recommended temperature conditions for enhanced product life: Be sure to TS point (negative pads) controlled below 85 °C, COB recommendation colloid surface temperature control  $\leq 200$  °C.

保证散热前提条件为：请务必将TS点（负极焊盘）控制在85℃以下，建议COB胶体表面温度控制 $\leq 200$ ℃。

#### 5. The drive control驱动控制：

Drive this product at constant current. Output current range specifications should be according to the operational and other conditions, as mentioned in data sheet. Before using a constant voltage source or altered specifications other than recommended, please consider risk factors. 本产品需使用恒流源进行驱动，且输出电流符合规格书上的功率使用范围，如需使用恒压源或其他使用条件，请进行使用效果风险评估。

#### 6. Other其他：

Product is not suitable to use in following conditions 本产品不可在以下条件下使用，如果产品在以下条件下使用，评估其使用效果和风险是有必要的：

- Direct or indirect wet / damp conditions, such as rain, etc.;
- 直接或间接的打湿或受潮，比如淋雨等；
- In contact with sea water and erosive materials
- 被海水损害或侵蚀；
- Exposed to corrosive gases (e.g., Cl<sub>2</sub>, H<sub>2</sub>S, NH<sub>3</sub>, SO<sub>x</sub>, NO<sub>x</sub>, etc.);
- 被暴露于腐蚀性气体(如 Cl<sub>2</sub>, H<sub>2</sub>S、NH<sub>3</sub>、SO<sub>x</sub>、NO<sub>x</sub>等)；
- Exposed to dust, liquids or oils;
- 被暴露于粉尘、液体或油；

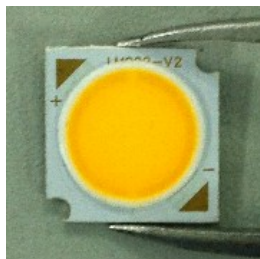

**OK**

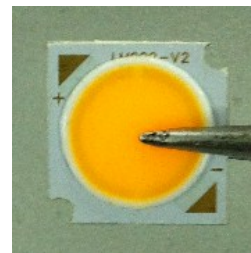

**NG**





修订次数	修订人	修订内容	修订日期	版次
1	尹键	电压更改 34-36-40	2018. 4. 11	A/0
2	杨亮	新增2700K光通量850-920-1030	2018. 4. 12	A/0
3	祝召兵	新增6000±300K光通量940-1000-1100lm	2018. 6. 26	A/0
4	苏国强	新增3000K光通量980-1040-1150lm	2020. 5. 26	A/0
5	莫家强	4000K光通量950-1010-1100变更为1030-1100-1210lm	2021. 07. 15	A/0
6				
7				
8				
9				
10				
11				
12				
13				
14				
15				
16				
17				
18				
19				
20				
21				
22				
23				
24				
25				
26				