

H11G1, H11G2, H11G3
H11G1X



ISOCOM
COMPONENTS



**HIGH VOLTAGE DARLINGTON
OUTPUT OPTICALLY COUPLED
ISOLATOR**

APPROVALS

- UL recognised, File No. E91231
Package Code " JJ "

'X' SPECIFICATION APPROVALS

- H11G1X VDE 0884 in 3 available lead form :
- STD
- G form
- SMD approved to CECC 00802

DESCRIPTION

The H11G_ series are optically coupled isolators consisting of an infrared light emitting diode and a high voltage NPN silicon photo darlington which has an integral base-emitter resistor to optimise switching speed and elevated temperature characteristics in a standard 6pin dual in line plastic package.

FEATURES

- Options :-
10mm lead spread - add G after part no.
Surface mount - add SM after part no.
Tape&reel - add SMT&R after part no.
- High Isolation Voltage (5.3kV_{RMS}, 7.5kV_{PK})
- High Current Transfer Ratio (1000% min)
- High BV_{CEO} (H11G1 - 100V min.)
- Low collector dark current :-
100nA max. at 80V V_{CE}
- Low input current 1mA I_F

APPLICATIONS

- Modems
- Copiers, facsimiles
- Numerical control machines
- Signal transmission between systems of different potentials and impedances

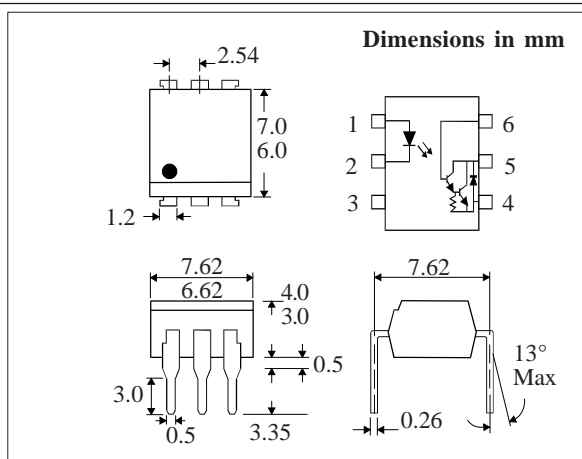
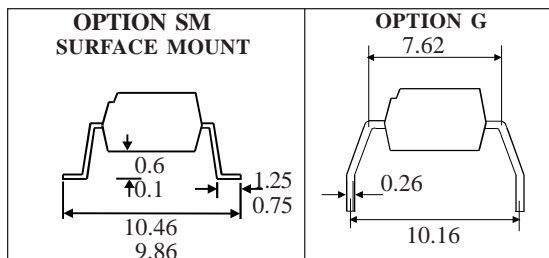

**ABSOLUTE MAXIMUM RATINGS
(25°C unless otherwise specified)**

Storage Temperature _____ -40°C to +125°C
Operating Temperature _____ -25°C to +100°C
Lead Soldering Temperature
(1/16 inch (1.6mm) from case for 10 secs) 260°C

INPUT DIODE

Forward Current _____ 50mA
Reverse Voltage _____ 6V
Power Dissipation _____ 70mW

OUTPUT TRANSISTOR

Collector-emitter Voltage BV_{CEO}
H11G3, H11G2, H11G1 _____ 55, 80, 100V
Collector-base Voltage BV_{CBO}
H11G3, H11G2, H11G1 _____ 55, 80, 100V
Emitter-base Voltage BV_{EBO} _____ 6V
Collector Current _____ 150mA
Power Dissipation _____ 300mW

POWER DISSIPATION

Total Power Dissipation _____ 350mW

ISOCOM COMPONENTS LTD
Unit 25B, Park View Road West,
Park View Industrial Estate, Brenda Road
Hartlepool, TS25 1UD England Tel: (01429)863609
Fax: (01429) 863581 e-mail sales@isocom.co.uk

ELECTRICAL CHARACTERISTICS ($T_A = 25^\circ\text{C}$ Unless otherwise noted)

PARAMETER		MIN	TYP	MAX	UNITS	TEST CONDITION
Input	Forward Voltage (V_F)		1.2	1.5	V	$I_F = 10\text{mA}$
	Reverse Current (I_R)			10	μA	$V_R = 4\text{V}$
Output	Collector-emitter Breakdown (BV_{CEO})				V	$I_C = 1\text{mA}$
	H11G1	100			V	$I_C = 1\text{mA}$
	H11G2	80			V	$I_C = 1\text{mA}$
	H11G3	55			V	$I_C = 1\text{mA}$
	Collector-base Breakdown (BV_{CBO})				V	$I_C = 100\mu\text{A}$
	H11G1	100			V	$I_C = 100\mu\text{A}$
	H11G2	80			V	$I_C = 100\mu\text{A}$
	H11G3	55			V	$I_C = 100\mu\text{A}$
	Emitter-base Breakdown (BV_{EBO})	6			V	$I_E = 0.1\text{mA}$
	Collector-emitter Dark Current (I_{CEO})				nA	$V_{CE} = 80\text{V}$
H11G1			100	nA	$V_{CE} = 60\text{V}$	
H11G2			100	nA	$V_{CE} = 30\text{V}$	
H11G3			100	nA		
Coupled	Collector Output Current (I_C)				mA	$10\text{mA } I_F, 1.2\text{V } V_{CE}$
	H11G1, H11G2	100			mA	$1\text{mA } I_F, 5\text{V } V_{CE}$
	H11G1, H11G2	5			mA	$1\text{mA } I_F, 5\text{V } V_{CE}$
	H11G3	2			mA	
	Collector-emitter Saturation Voltage $V_{CE(SAT)}$				V	$1\text{mA } I_F, 1\text{mA } I_C$
	H11G1, H11G2			1.0	V	$16\text{mA } I_F, 50\text{mA } I_C$
	H11G1, H11G2			1.2	V	$20\text{mA } I_F, 50\text{mA } I_C$
	H11G3			1.2	V	See note 1
	Input to Output Isolation Voltage V_{ISO}	5300			V_{RMS}	See note 1
		7500			V_{PK}	$V_{IO} = 500\text{V}$ (note 1)
	Input-output Isolation Resistance R_{ISO}	5×10^{10}	10^{11}		Ω	$V = 0, f = 1\text{MHz}$
Input-output Capacitance C_f		0.6		pF		
Response time (Rise), tr		100		μs	$I_C = 20\text{mA}, V_{CE} = 2\text{V}, R_L = 100\Omega$	
Response time (Fall), tf		20		μs		

Note 1 Measured with input leads shorted together and output leads shorted together.

Note 2 Special Selections are available on request. Please consult the factory.

FIGURE 1

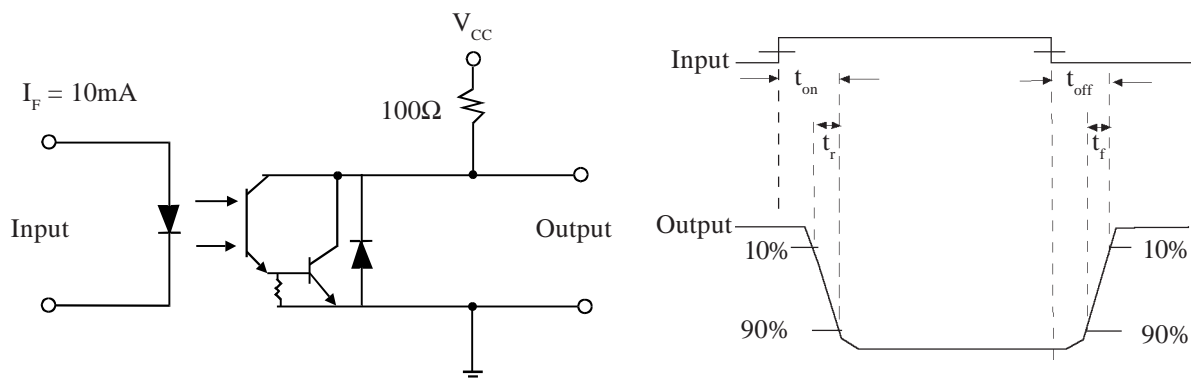

Collector Power Dissipation vs. Ambient Temperature

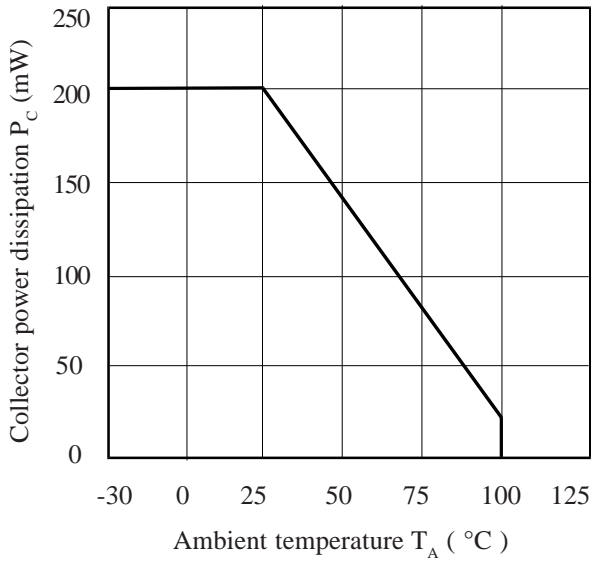

Normalized Output Current vs. Collector-emitter Voltage

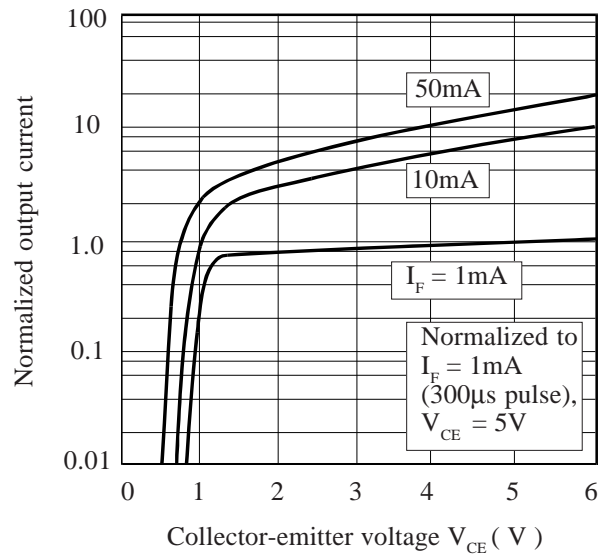

Forward Current vs. Ambient Temperature

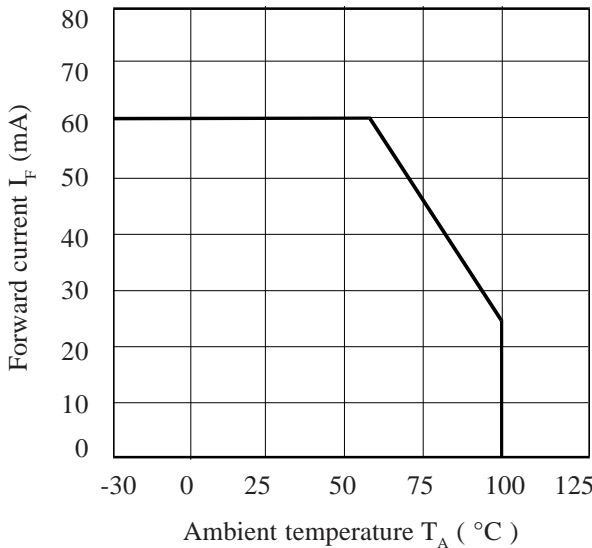

Normalized Output Current vs. Ambient Temperature

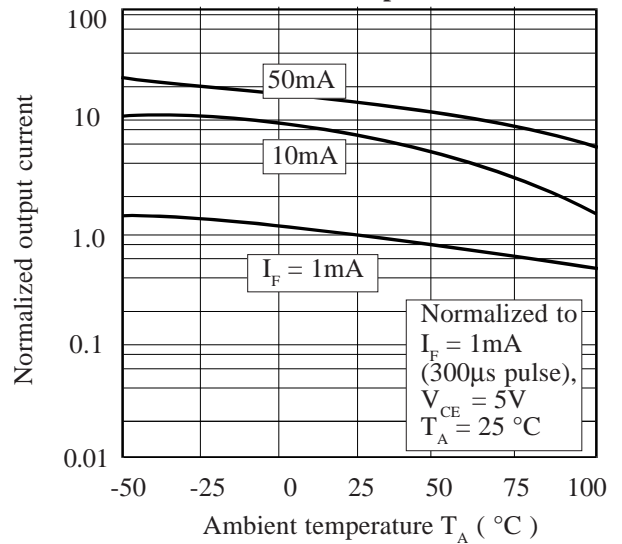

Normalized Output Current vs. Input Current

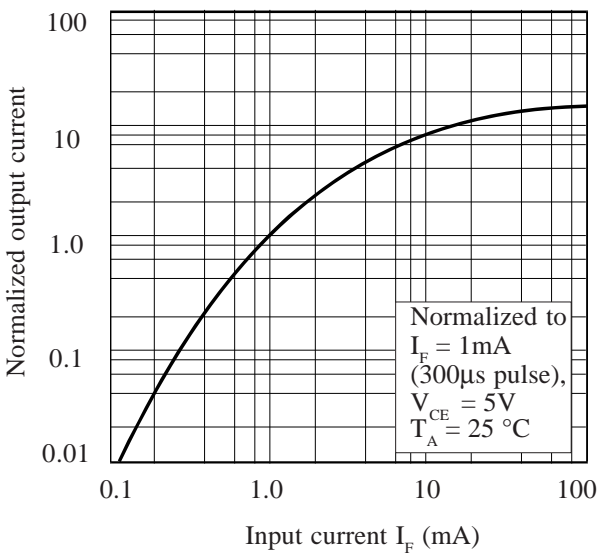

Collector Dark Current vs. Ambient Temperature

