



General description

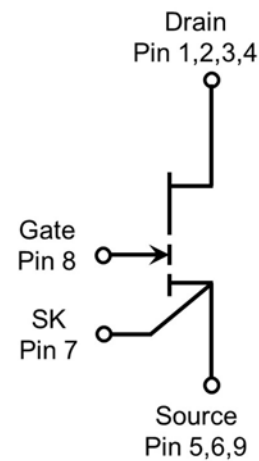
650V GaN-on-Silicon Enhancement-mode
Power Transistor in Dual Flat No-lead Package
(DFN) with 8 mm × 8 mm size .

Features

- Enhancement-mode transistor - normally-OFF power switch
- Ultra-high switching frequency
- No reverse-recovery charge
- Low gate charge, low output charge
- Qualified for industrial applications according to JEDEC Standards
- ESD safeguard
- RoHS, Pb-free, REACH-compliant

Applications

- AC-DC converters
- DC-DC converters
- Totem pole PFC
- Fast battery charging
- High-density power conversion
- High-efficiency power conversion



Gate	8
Drain	1, 2, 3, 4
Kelvin Source	7
Source	5, 6, 9



Maximum ratings

at $T_j = 25\text{ °C}$ unless otherwise specified. Continuous application of maximum ratings can deteriorate transistor lifetime.
For further information, contact CloudSemi sales office.

Table 3 Maximum rating

Parameters	Symbols	Values			Units	Notes/Test Conditions
		Min.	Typ.	Max.		
Drain-source voltage	$V_{DS, max}$	-	-	650	V	$V_{GS} = 0\text{ V}$, $I_D = 10\text{ }\mu\text{A}$
Drain-source voltage transient ¹	$V_{DS, transient}$	-	-	750	V	$V_{GS} = 0\text{ V}$, $V_{DS} = 750\text{ V}$
Continuous current, drain-source	I_D	-	-	17	A	$T_c = 25\text{ °C}$
Pulsed current, drain-source ²	$I_{D, pulse}$	-	-	32	A	$T_c = 25\text{ °C}$; $V_G = 6\text{ V}$
Pulsed current, drain-source ²	$I_{D, pulse}$	-	-	18	A	$T_c = 125\text{ °C}$; $V_G = 6\text{ V}$
Gate-source voltage, continuous ³	V_{GS}	-1.4	-	+7	V	$T_j = -55\text{ °C}$ to 150 °C
Gate-source voltage, pulsed	$V_{GS, pulse}$	-	-	+10	V	$T_j = -55\text{ °C}$ to 150 °C ; $t_{pulse} = 50\text{ ns}$, $f = 100\text{ kHz}$; open drain
Power dissipation	P_{tot}	-	-	113	W	$T_c = 25\text{ °C}$
Operating temperature	T_j	-55	-	+150	°C	
Storage temperature	T_{stg}	-55	-	+150	°C	

1. $V_{DS, transient}$ is intended for surge rating during non-repetitive events, $t_{pulse} < 1\text{ }\mu\text{s}$.

2. Pulse width = $10\text{ }\mu\text{s}$.

3. The minimum V_{GS} is clamped by ESD protection circuit, as shown in Figure 8.

Thermal characteristics

Table 4 Thermal characteristics

Parameters	Symbols	Values			Units	Notes/Test Conditions
		Min.	Typ.	Max.		
Thermal resistance, junction-case	R_{thJC}	-	-	1.1	°C/W	
Reflow soldering temperature	T_{sold}	-	-	260	°C	MSL3



Electrical characteristics

at $T_j = 25\text{ }^\circ\text{C}$, unless specified otherwise.

Table 5 Static characteristics

Parameters	Symbols	Values			Units	Notes/Test Conditions
		Min.	Typ.	Max.		
Gate threshold voltage	$V_{GS(TH)}$	1.2	1.7	2.5	V	$I_D = 17.2\text{ mA}; V_{DS} = V_{GS}; T_j = 25\text{ }^\circ\text{C}$
		-	1.6	-		$I_D = 17.2\text{ mA}; V_{DS} = V_{GS}; T_j = 125\text{ }^\circ\text{C}$
Drain-source leakage current	I_{DSS}	-	0.6	20	μA	$V_{DS} = 650\text{ V}; V_{GS} = 0\text{ V}; T_j = 25\text{ }^\circ\text{C}$
		-	1	-		$V_{DS} = 650\text{ V}; V_{GS} = 0\text{ V}; T_j = 125\text{ }^\circ\text{C}$
Gate-source leakage current	I_{GSS}	-	40	200	μA	$V_{GS} = 6\text{ V}; V_{DS} = 0\text{ V}$
Drain-source on-state resistance	$R_{DS(on)}$	-	100	140	$\text{m}\Omega$	$V_{GS} = 6\text{ V}; I_D = 5\text{ A}; T_j = 25\text{ }^\circ\text{C}$
		-	200	-	$\text{m}\Omega$	$V_{GS} = 6\text{ V}; I_D = 5\text{ A}; T_j = 125\text{ }^\circ\text{C}$
Gate resistance	R_G	-	3.5	-	Ω	$f = 5\text{ MHz}; \text{open drain}$

Table 6 Dynamic characteristics

Parameters	Symbols	Values			Units	Notes/Test Conditions
		Min.	Typ.	Max.		
Input capacitance	C_{iss}	-	125	-	pF	$V_{GS} = 0\text{ V}; V_{DS} = 400\text{ V}; f = 100\text{ kHz}$
Output capacitance	C_{oss}	-	40	-	pF	$V_{GS} = 0\text{ V}; V_{DS} = 400\text{ V}; f = 100\text{ kHz}$
Reverse transfer capacitance	C_{rss}	-	0.5	-	pF	$V_{GS} = 0\text{ V}; V_{DS} = 400\text{ V}; f = 100\text{ kHz}$
Effective output capacitance, energy related ¹	$C_{o(er)}$	-	53	-	pF	$V_{GS} = 0\text{ V}; V_{DS} = 0\text{ to }400\text{ V}$
Effective output capacitance, time related ²	$C_{o(tr)}$	-	81	-	pF	$V_{GS} = 0\text{ V}; V_{DS} = 0\text{ to }400\text{ V}$
Output charge	Q_{oss}	-	33	-	nC	$V_{GS} = 0\text{ V}; V_{DS} = 0\text{ to }400\text{ V}$

1. $C_{o(er)}$ is the fixed capacitance that gives the same stored energy as C_{oss} while V_{DS} is rising from 0 to 400 V.

2. $C_{o(tr)}$ is the fixed capacitance that gives the same charging time as C_{oss} while V_{DS} is rising from 0 to 400 V.



Table 7 Gate charge characteristics

Parameters	Symbols	Values			Units	Notes/Test Conditions
		Min.	Typ.	Max.		
Gate charge	Q_G	-	3.3	-	nC	$V_{GS} = 0$ to 6 V; $V_{DS} = 400$ V; $I_D = 5$ A
Gate-source charge	Q_{GS}	-	0.3	-	nC	
Gate-drain charge	Q_{GD}	-	1.25	-	nC	
Gate plateau voltage	V_{Plat}	-	2.4	-	V	$V_{DS} = 400$ V; $I_D = 5$ A

Table 8 Reverse conduction characteristics

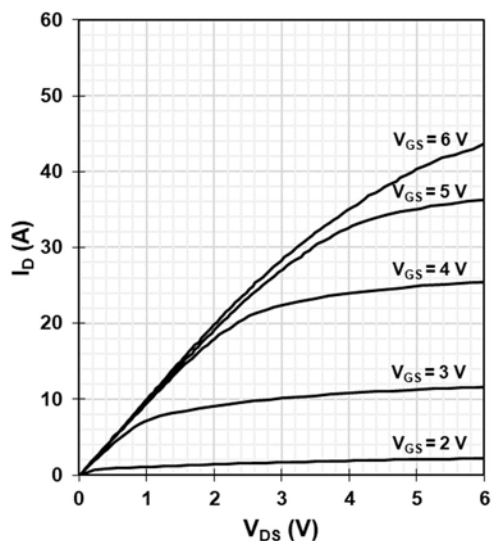
Parameters	Symbols	Values			Units	Notes/Test Conditions
		Min.	Typ.	Max.		
Source-drain reverse voltage	V_{SD}	-	2.5	-	V	$V_{GS} = 0$ V; $I_{SD} = 5$ A
Pulsed current, reverse	$I_{S, pulse}$	-	28	-	A	$V_{GS} = 6$ V
Reverse recovery charge	Q_{rr}	-	0	-	nC	$I_{SD} = 5$ A; $V_{DS} = 400$ V
Reverse recovery time	t_{rr}	-	0	-	ns	
Peak reverse recovery current	I_{rrm}	-	0	-	A	



Electrical characteristics diagrams

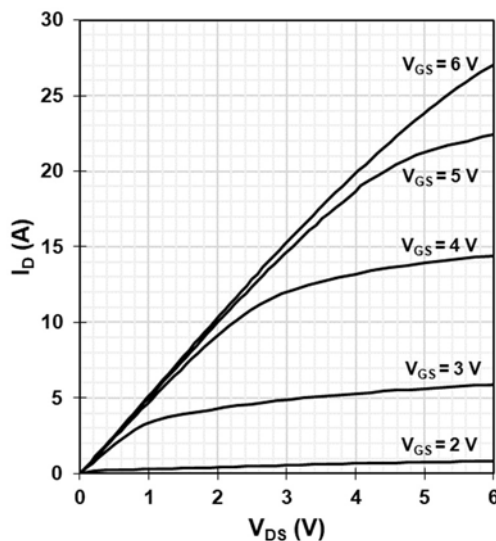
at $T_j = 25\text{ }^\circ\text{C}$, unless specified otherwise.

Figure 1 Typ. output characteristics



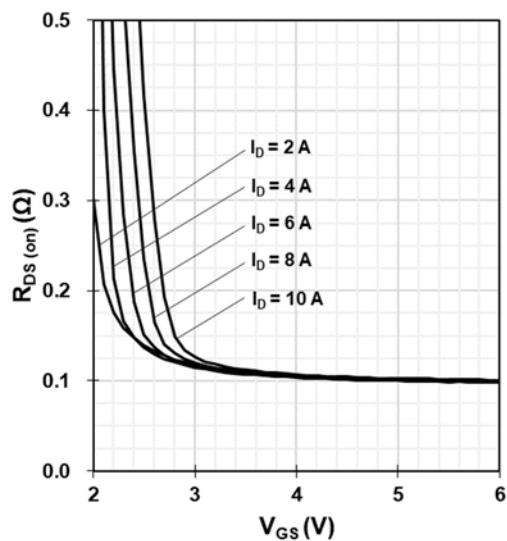
$$I_D = f(V_{DS}, V_{GS}); T_j = 25\text{ }^\circ\text{C}$$

Figure 2 Typ. output characteristics



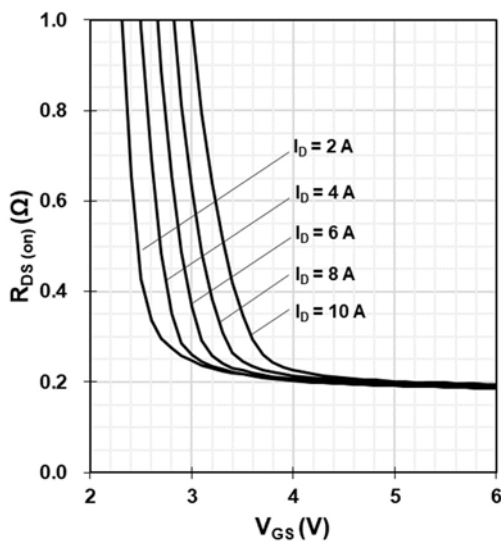
$$I_D = f(V_{DS}, V_{GS}); T_j = 125\text{ }^\circ\text{C}$$

Figure 3 Typ. drain-source on-state resistance



$$R_{DS(on)} = f(I_D, V_{GS}); T_j = 25\text{ }^\circ\text{C}$$

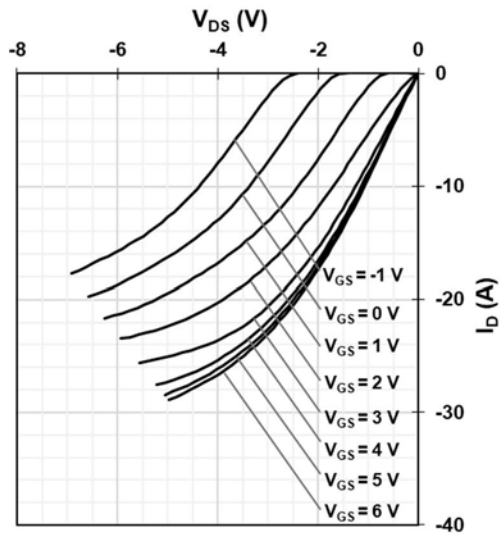
Figure 4 Typ. drain-source on-state resistance



$$R_{DS(on)} = f(I_D, V_{GS}); T_j = 125\text{ }^\circ\text{C}$$

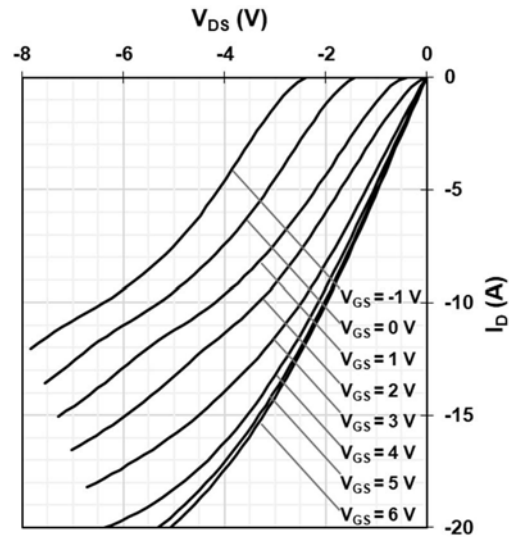


Figure 5 Typ. channel reverse characteristics



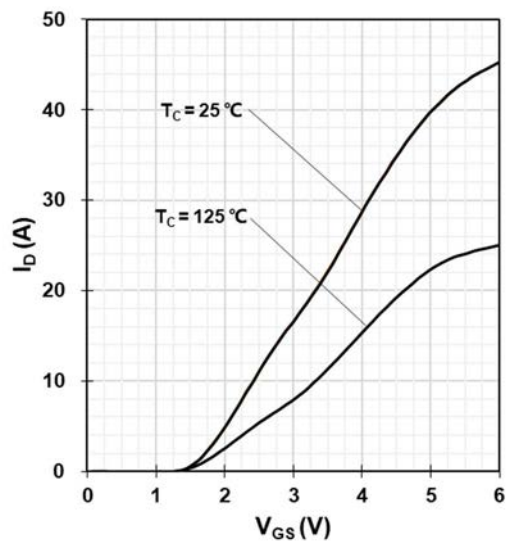
$$I_D = f(V_{DS}, V_{GS}); T_J = 25\text{ }^\circ\text{C}$$

Figure 6 Typ. channel reverse characteristics



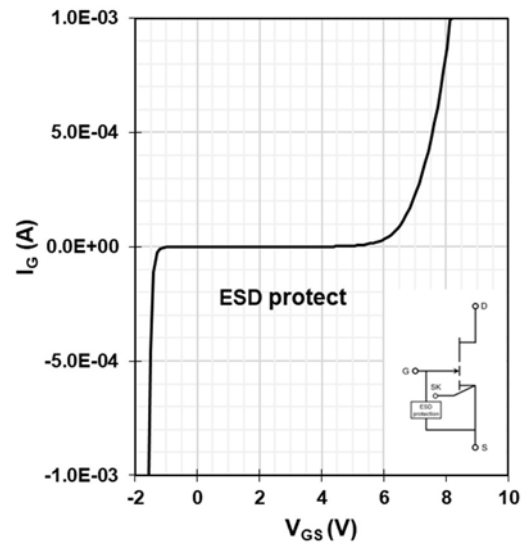
$$I_D = f(V_{DS}, V_{GS}); T_J = 125\text{ }^\circ\text{C}$$

Figure 7 Typ. transfer characteristics



$$I_D = f(V_{GS}); V_{DS} = 5\text{ V}$$

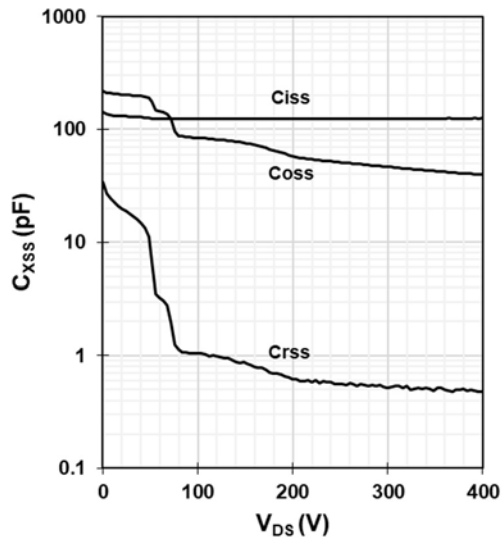
Figure 8 Typ. gate-to-source leakage



$$I_G = f(V_{GS}); I_G \text{ reverse turn on by ESD unit; } V_D = \text{open}$$

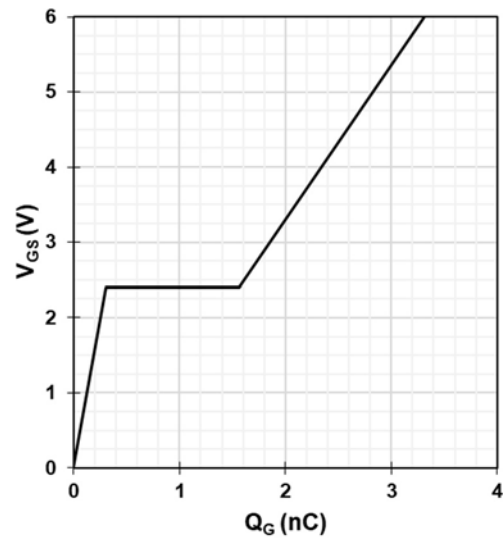


Figure 9 Typ. capacitances



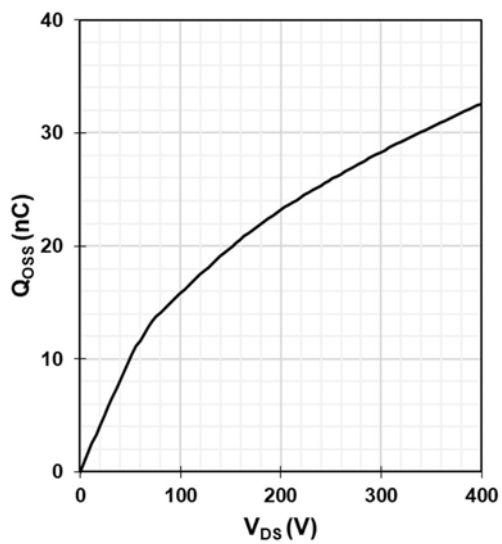
$C_{XSS} = f(V_{DS})$; Freq. = 100 kHz

Figure 10 Typ. gate charge



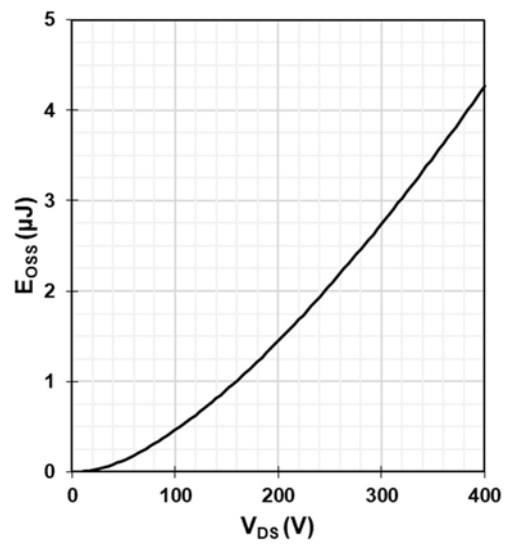
$V_{GS} = f(Q_G)$; $V_{DC-LINK} = 400$ V; $I_D = 5$ A

Figure 11 Typ. output charge



$Q_{OSS} = f(V_{DS})$; Freq. = 100 kHz

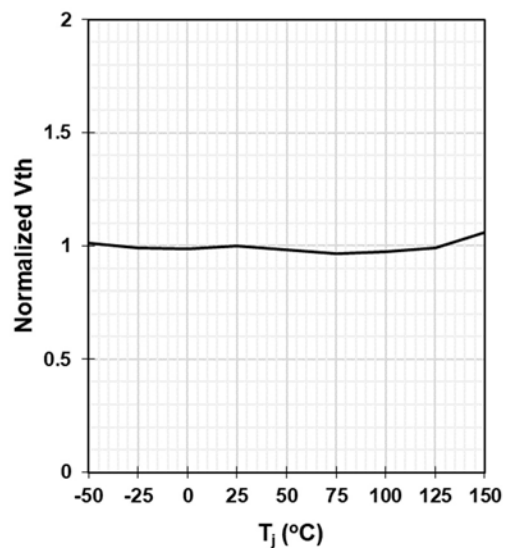
Figure 12 Typ. C_{OSS} stored energy



$E_{OSS} = f(V_{DS})$; Freq. = 100 kHz

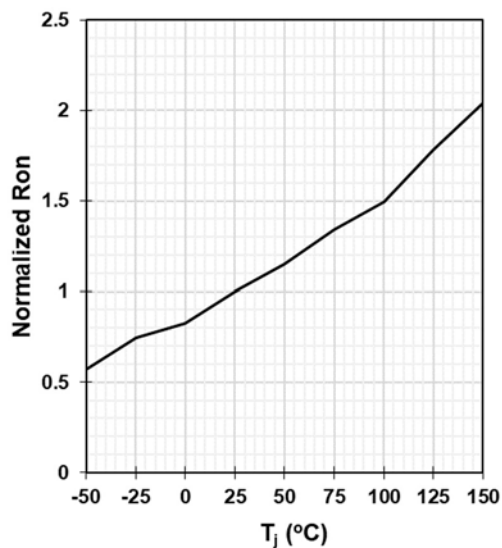


Figure 13 Gate threshold voltage



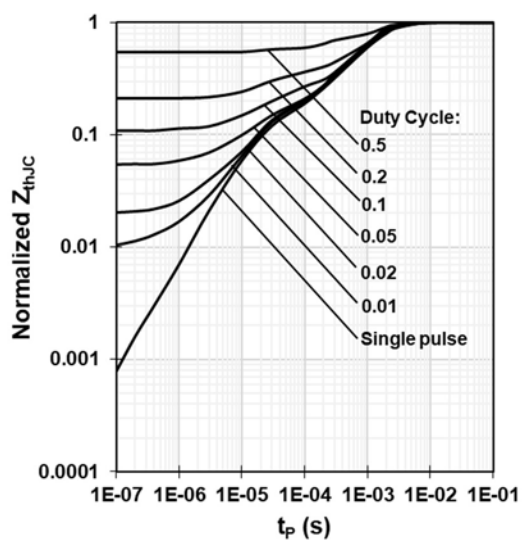
$$V_{TH} = f(T_j); V_{GS} = V_{DS}; I_D = 17.2 \text{ mA}$$

Figure 14 Drain-source on-state resistance



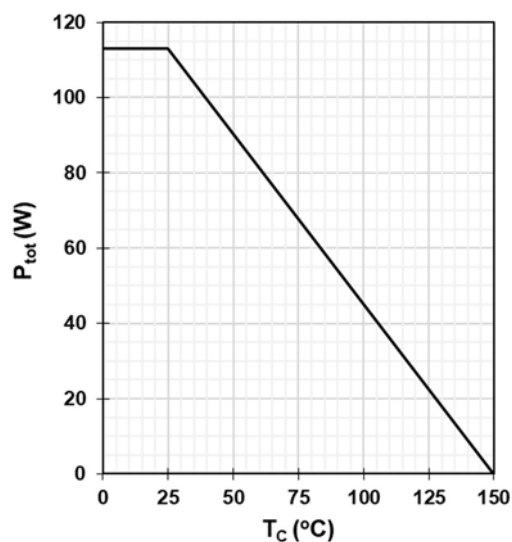
$$R_{DS(on)} = f(T_j); I_D = 5 \text{ A}; V_{GS} = 6 \text{ V}$$

Figure 15 Max. transient thermal impedance



$$Z_{thJC} = f(t_p, D)$$

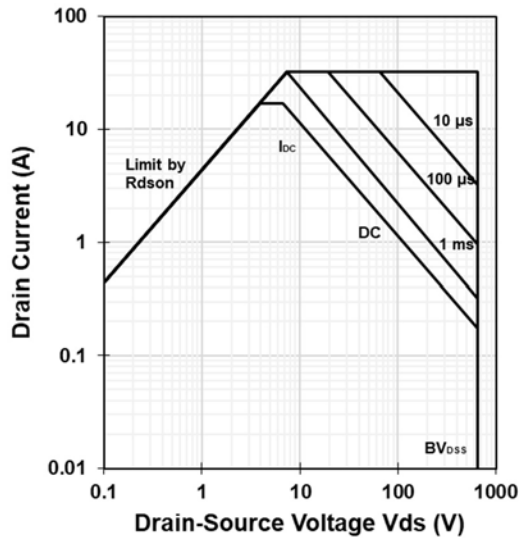
Figure 16 Power dissipation



$$P_{tot} = f(T_c)$$

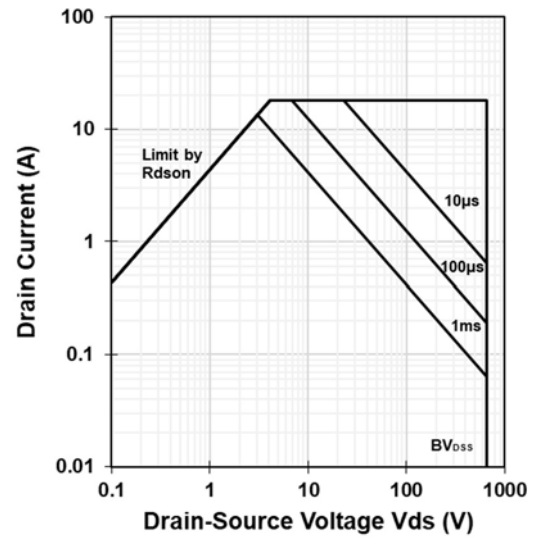


Figure 17 Safe operating area



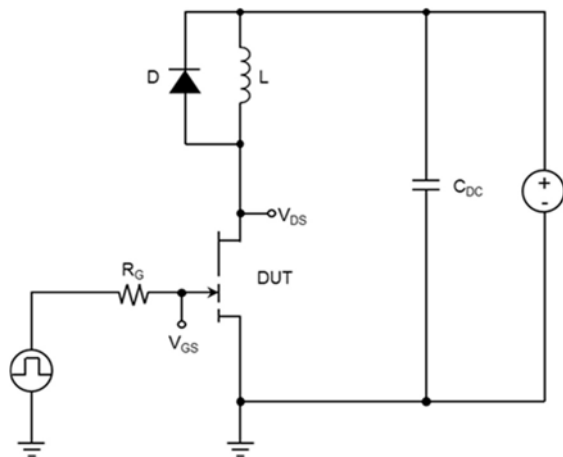
$I_D = f(V_{DS}); T_C = 25\text{ }^\circ\text{C}$

Figure 18 Safe operating area



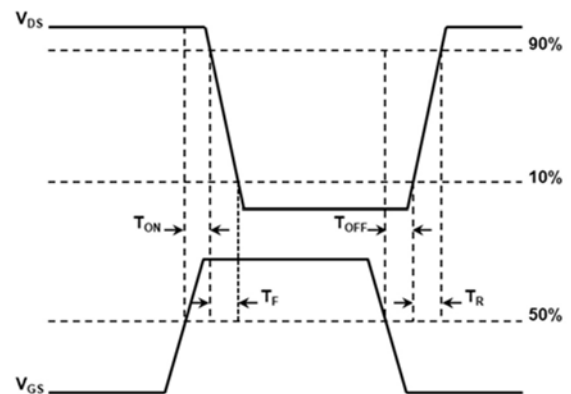
$I_D = f(V_{DS}); T_C = 125\text{ }^\circ\text{C}$

Figure 19 Max. transient thermal impedance



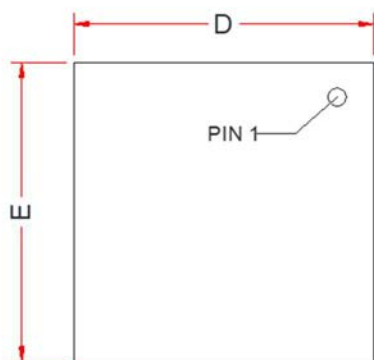
$V_{DS} = 400\text{ V}, I_D = 10\text{ A}, L = 318\text{ }\mu\text{H}, V_{GS} = 6\text{ V},$
 $R_{on} = 10\text{ }\Omega, R_{off} = 2\text{ }\Omega$

Figure 20 Typ. switching times waveform

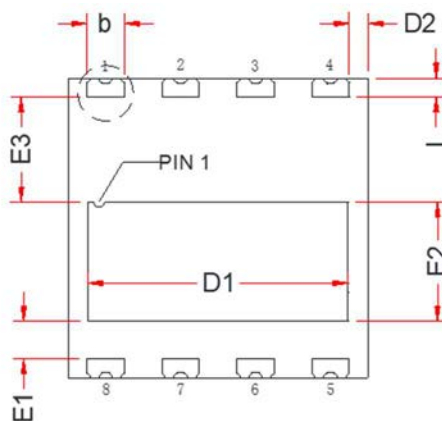




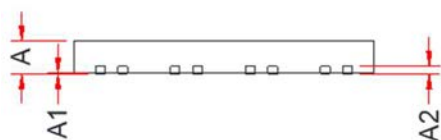
Package outlines



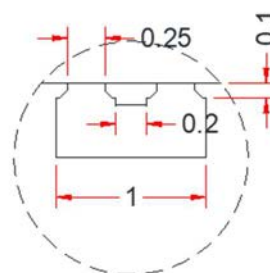
TOP VIEW



BOTTOM VIEW



SIDE VIEW

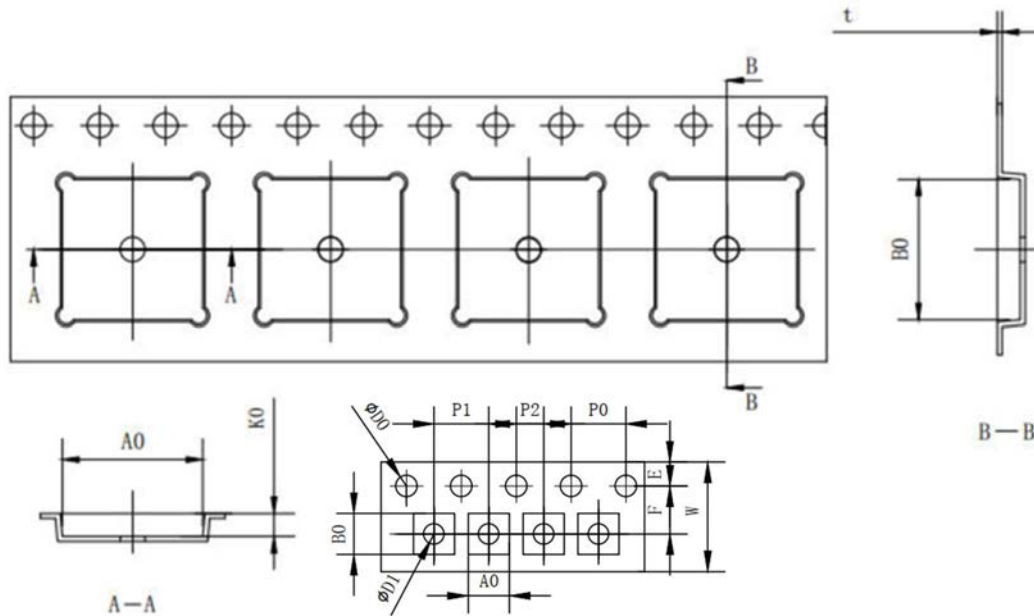


LEAD DETAIL

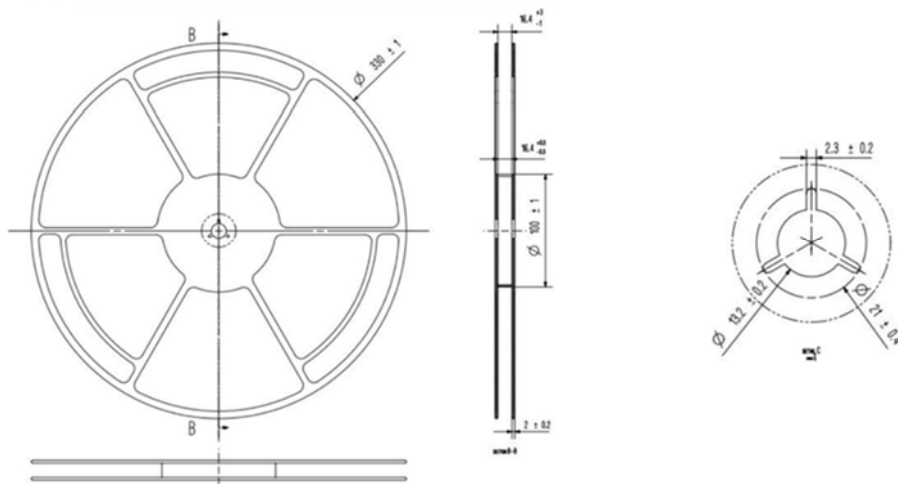
	MIN	MID	MAX
A	0.75	0.85	0.95
A1	0.00	0.02	0.05
A2	0.203REF		
b	0.95	1.00	1.05
D	8.00BSC		
D1	6.84	6.94	7.04
D2	0.40	0.50	0.60
E	8.00BSC		
E1	0.90	1.00	1.10
E2	3.10	3.20	3.30
E3	2.70	2.80	2.90
e	2.00BSC		
L	0.40	0.50	0.60



Reel information



SYMBOL	DIMENSION	SYMBOL	DIMENSION
W	16.00±0.30	10P0	40.00±0.20
E	1.75±0.10	P1	12.00±0.10
F	7.50±0.10	A0	8.30±0.10
D0	1.50±0.10	B0	8.30±0.10
D1	1.50±0.10	K0	1.10±0.10
P0	4.00±0.10	T	0.30±0.05
P2	2.00±0.10		





Attention

- Any and all HUA XUAN YANG ELECTRONICS products described or contained herein do not have specifications that can handle applications that require extremely high levels of reliability, such as life-support systems, aircraft's control systems, or other applications whose failure can be reasonably expected to result in serious physical and/or material damage. Consult with your HUA XUAN YANG ELECTRONICS representative nearest you before using any HUA XUAN YANG ELECTRONICS products described or contained herein in such applications.

- HUA XUAN YANG ELECTRONICS assumes no responsibility for equipment failures that result from using products at values that exceed, even momentarily, rated values (such as maximum ratings, operating condition ranges, or other parameters) listed in products specifications of any and all HUA XUAN YANG ELECTRONICS products described or contained herein.

- Specifications of any and all HUA XUAN YANG ELECTRONICS products described or contained herein stipulate the performance, characteristics, and functions of the described products in the independent state, and are not guarantees of the performance, characteristics, and functions of the described products as mounted in the customer's products or equipment. To verify symptoms and states that cannot be evaluated in an independent device, the customer should always evaluate and test devices mounted in the customer's products or equipment.

- HUA XUAN YANG ELECTRONICS CO.,LTD. strives to supply high-quality high-reliability products. However, any and all semiconductor products fail with some probability. It is possible that these probabilistic failures could give rise to accidents or events that could endanger human lives, that could give rise to smoke or fire, or that could cause damage to other property. When designing equipment, adopt safety measures so that these kinds of accidents or events cannot occur. Such measures include but are not limited to protective circuits and error prevention circuits for safe design, redundant design, and structural design.

- In the event that any or all HUA XUAN YANG ELECTRONICS products(including technical data, services) described or contained herein are controlled under any of applicable local export control laws and regulations, such products must not be exported without obtaining the export license from the authorities concerned in accordance with the above law.

- No part of this publication may be reproduced or transmitted in any form or by any means, electronic or mechanical, including photocopying and recording, or any information storage or retrieval system, or otherwise, without the prior written permission of HUA XUAN YANG ELECTRONICS CO.,LTD.

- Information (including circuit diagrams and circuit parameters) herein is for example only ; it is not guaranteed for volume production. HUA XUAN YANG ELECTRONICS believes information herein is accurate and reliable, but no guarantees are made or implied regarding its use or any infringements of intellectual property rights or other rights of third parties.

- Any and all information described or contained herein are subject to change without notice due to product/technology improvement, etc. When designing equipment, refer to the "Delivery Specification" for the HUA XUAN YANG ELECTRONICS product that you intend to use.