

High Voltage Power MOSFET

IXTT1N450HV IXTH1N450HV

$V_{DSS} = 4500V$
 $I_{D25} = 1A$
 $R_{DS(on)} \leq 80\Omega$

N-Channel Enhancement Mode

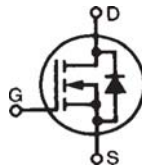

| Symbol | Test Conditions | Maximum Ratings | |
|---------------|---|-------------------|------------|
| V_{DSS} | $T_J = 25^\circ C$ to $150^\circ C$ | 4500 | V |
| V_{DGR} | $T_J = 25^\circ C$ to $150^\circ C$, $R_{GS} = 1M\Omega$ | 4500 | V |
| V_{GSS} | Continuous | ± 20 | V |
| V_{GSM} | Transient | ± 30 | V |
| I_{D25} | $T_C = 25^\circ C$ | 1 | A |
| I_{DM} | $T_C = 25^\circ C$, Pulse Width Limited by T_{JM} | 3 | A |
| P_D | $T_C = 25^\circ C$ | 520 | W |
| T_J | | - 55 ... +150 | $^\circ C$ |
| T_{JM} | | 150 | $^\circ C$ |
| T_{stg} | | - 55 ... +150 | $^\circ C$ |
| T_L | Maximum Lead Temperature for Soldering | 300 | $^\circ C$ |
| T_{SOLD} | 1.6 mm (0.062in.) from Case for 10s | 260 | $^\circ C$ |
| F_C | Mounting Force (TO-263HV) | 10..65 / 22..14.6 | N/lb |
| M_d | Mounting Torque (TO-247HV) | 1.13/10 | Nm/lb.in |
| Weight | TO-263HV | 2.5 | g |
| | TO-247HV | 6.0 | g |

TO-268HV (IXTT)

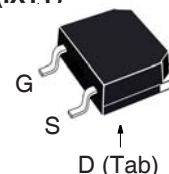

TO-247HV (IXTH)

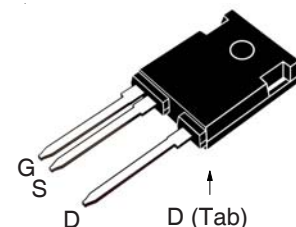

G = Gate D = Drain
 S = Source Tab = Drain

Features

- High Blocking Voltage
- High Voltage Package

Advantages

- Easy to Mount
- Space Savings
- High Power Density

Applications

- High Voltage Power Supplies
- Capacitor Discharge Applications
- Pulse Circuits
- Laser and X-Ray Generation Systems

| Symbol | Test Conditions ($T_J = 25^\circ C$, Unless Otherwise Specified) | Characteristic Values | | |
|--------------|--|-----------------------|------|--------------|
| | | Min. | Typ. | Max. |
| $V_{GS(th)}$ | $V_{DS} = V_{GS}$, $I_D = 250\mu A$ | 3.5 | | 6.0 V |
| I_{GSS} | $V_{GS} = \pm 20V$, $V_{DS} = 0V$ | | | ± 100 nA |
| I_{DSS} | $V_{DS} = 3.6kV$, $V_{GS} = 0V$ $V_{DS} = 4.5kV$ $V_{DS} = 3.6kV$ $T_J = 100^\circ C$ | | | 5 μA |
| | | | | 25 μA |
| | | | | 15 μA |
| $R_{DS(on)}$ | $V_{GS} = 10V$, $I_D = 50mA$, Note 1 | | | 80 Ω |

| Symbol | Test Conditions ($T_J = 25^\circ\text{C}$, Unless Otherwise Specified) | Characteristic Values | | |
|--------------|---|-----------------------|------|--------------------|
| | | Min. | Typ. | Max. |
| g_{fs} | $V_{DS} = 50\text{V}$, $I_D = 200\text{mA}$, Note 1 | 0.40 | 0.70 | S |
| C_{iss} | $V_{GS} = 0\text{V}$, $V_{DS} = 25\text{V}$, $f = 1\text{MHz}$ | | 1700 | pF |
| C_{oss} | | | 80 | pF |
| C_{rss} | | | 29 | pF |
| R_{Gi} | Gate Input Resistance | | 12 | Ω |
| $t_{d(on)}$ | Resistive Switching Times $V_{GS} = 10\text{V}$, $V_{DS} = 500\text{V}$, $I_D = 0.5 \cdot I_{D25}$ $R_G = 10\Omega$ (External) | | 30 | ns |
| t_r | | | 43 | ns |
| $t_{d(off)}$ | | | 73 | ns |
| t_f | | | 120 | ns |
| $Q_{g(on)}$ | $V_{GS} = 10\text{V}$, $V_{DS} = 1\text{kV}$, $I_D = 0.5 \cdot I_{D25}$ | | 46 | nC |
| Q_{gs} | | | 8 | nC |
| Q_{gd} | | | 23 | nC |
| R_{thJC} | TO-247HV | | 0.24 | $^\circ\text{C/W}$ |
| R_{thCS} | | | 0.21 | $^\circ\text{C/W}$ |

Source-Drain Diode

| Symbol | Test Conditions ($T_J = 25^\circ\text{C}$, Unless Otherwise Specified) | Characteristic Values | | |
|----------|---|-----------------------|------|---------------|
| | | Min. | Typ. | Max. |
| I_S | $V_{GS} = 0\text{V}$ | | | 1 A |
| I_{SM} | Repetitive, Pulse Width Limited by T_{JM} | | | 5 A |
| V_{SD} | $I_F = 1\text{A}$, $V_{GS} = 0\text{V}$, Note 1 | | | 2.0 V |
| t_{rr} | $I_F = 1\text{A}$, $-di/dt = 50\text{A}/\mu\text{s}$, $V_R = 100\text{V}$ | | 1.75 | μs |

Note 1. Pulse test, $t \leq 300\mu\text{s}$, duty cycle, $d \leq 2\%$.

TO-268HV Outline

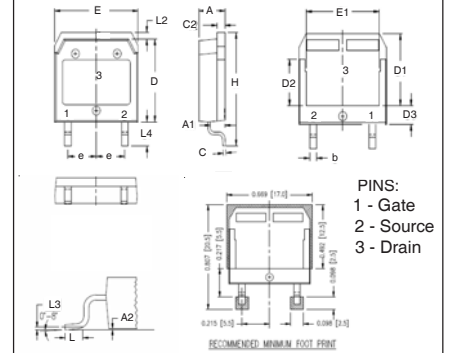

| SYM | INCHES | | MILLIMETER | |
|-----|--------|------|------------|-------|
| | MIN | MAX | MIN | MAX |
| A | .193 | .201 | 4.90 | 5.10 |
| A1 | .106 | .114 | 2.70 | 2.90 |
| A2 | .001 | .010 | 0.02 | 0.25 |
| b | .045 | .057 | 1.15 | 1.45 |
| C | .016 | .026 | 0.40 | 0.65 |
| C2 | .057 | .063 | 1.45 | 1.60 |
| D | .543 | .551 | 13.80 | 14.00 |
| D1 | .465 | .476 | 11.80 | 12.10 |
| D2 | .295 | .307 | 7.50 | 7.80 |
| D3 | .114 | .126 | 2.90 | 3.20 |
| E | .624 | .632 | 15.85 | 16.05 |
| E1 | .524 | .535 | 13.30 | 13.60 |
| E | .215 | BSC | 5.45 | BSC |
| H | .736 | .752 | 18.70 | 19.10 |
| L | .067 | .079 | 1.70 | 2.00 |
| L2 | .039 | .045 | 1.00 | 1.15 |
| L3 | .010 | BSC | 0.25 | BSC |
| L4 | .150 | .161 | 3.80 | 4.10 |

TO-247HV Outline

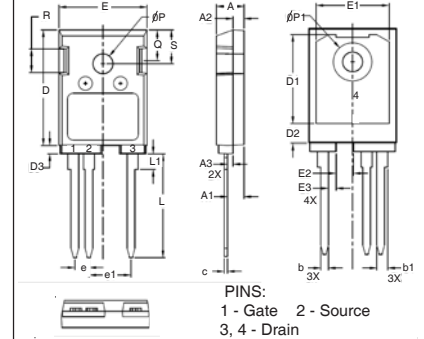

| SYM | INCHES | | MILLIMETERS | |
|-----|--------|------|-------------|-------|
| | MIN | MAX | MIN | MAX |
| A | .193 | .201 | 4.90 | 5.10 |
| A1 | .114 | .122 | 2.90 | 3.10 |
| A2 | .075 | .083 | 1.90 | 2.10 |
| A3 | .035 | .043 | 0.90 | 1.10 |
| b | .053 | .059 | 1.35 | 1.50 |
| b1 | .075 | .083 | 1.90 | 2.10 |
| c | .022 | .030 | 0.55 | 0.75 |
| D | .819 | .843 | 20.80 | 21.40 |
| D1 | .638 | .646 | 16.20 | 16.40 |
| D2 | .134 | .146 | 3.40 | 3.70 |
| D3 | .055 | .063 | 1.40 | 1.60 |
| E | .622 | .638 | 15.80 | 16.20 |
| E1 | .520 | .528 | 13.20 | 13.40 |
| E2 | .118 | .126 | 3.00 | 3.20 |
| E3 | .051 | .059 | 1.30 | 1.50 |
| e | .100 | BSC | 2.54 | BSC |
| e1 | .300 | BSC | 7.62 | BSC |
| L | .732 | .748 | 18.60 | 19.00 |
| L1 | .106 | .118 | 2.70 | 3.00 |
| ØP | .138 | .142 | 3.50 | 3.60 |
| ØP1 | .272 | .280 | 6.90 | 7.10 |
| Q | .216 | .224 | 5.50 | 5.70 |
| R | .165 | .169 | 4.20 | 4.30 |
| S | .240 | .248 | 6.10 | 6.30 |

IXYS Reserves the Right to Change Limits, Test Conditions, and Dimensions.

| | | | | | | | | | | |
|--|-----------|-----------|-----------|-----------|--------------|--------------|--------------|--------------|--------------|-------------|
| IXYS MOSFETs and IGBTs are covered by one or more of the following U.S. patents: | 4,835,592 | 4,931,844 | 5,049,961 | 5,237,481 | 6,162,665 | 6,404,065 B1 | 6,683,344 | 6,727,585 | 7,005,734 B2 | 7,157,338B2 |
| | 4,860,072 | 5,017,508 | 5,063,307 | 5,381,025 | 6,259,123 B1 | 6,534,343 | 6,710,405 B2 | 6,759,692 | 7,063,975 B2 | |
| | 4,881,106 | 5,034,796 | 5,187,117 | 5,486,715 | 6,306,728 B1 | 6,583,505 | 6,710,463 | 6,771,478 B2 | 7,071,537 | |

Fig. 1. Output Characteristics @ $T_J = 25^\circ\text{C}$

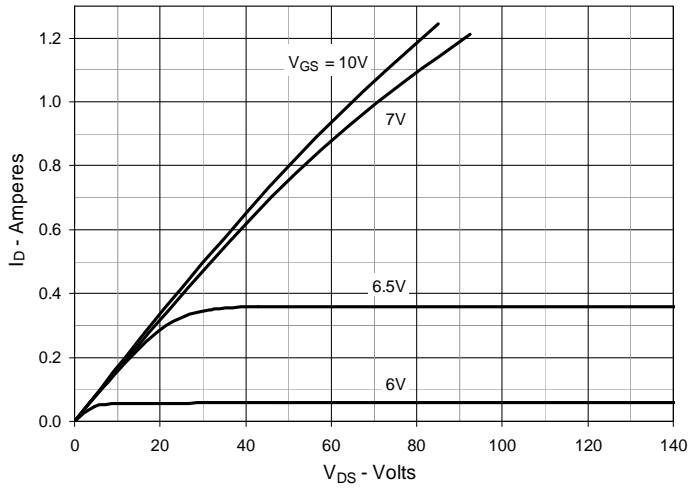

Fig. 2. Output Characteristics @ $T_J = 125^\circ\text{C}$

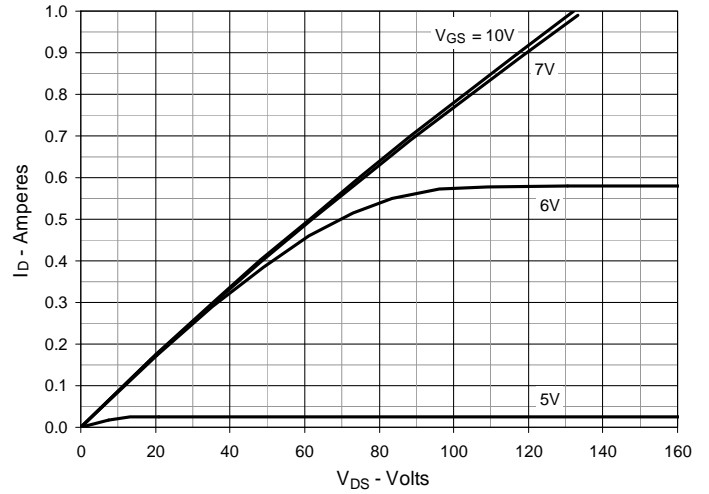

Fig. 3. $R_{DS(on)}$ Normalized to $I_D = 0.5\text{A}$ Value vs. Junction Temperature

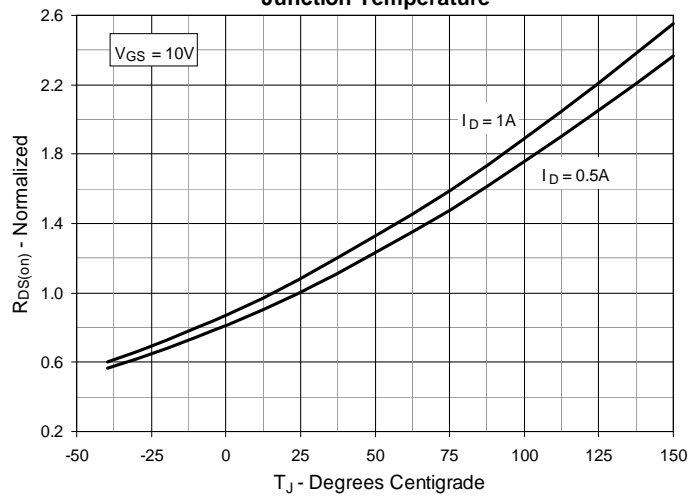

Fig. 4. $R_{DS(on)}$ Normalized to $I_D = 0.5\text{A}$ Value vs. Drain Current

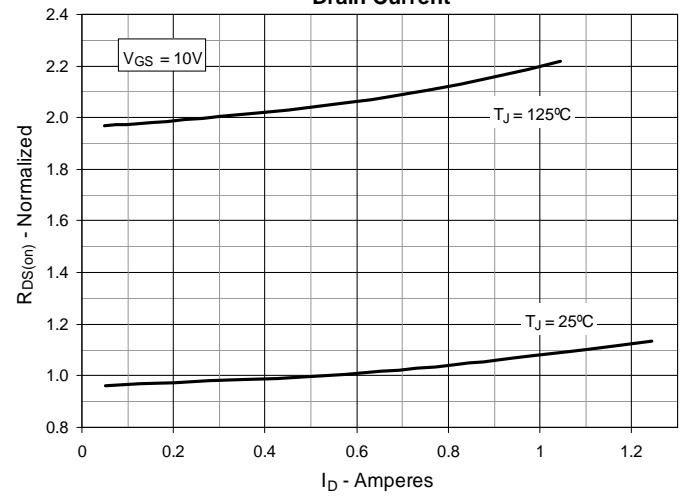

Fig. 5. Maximum Drain Current vs. Case Temperature

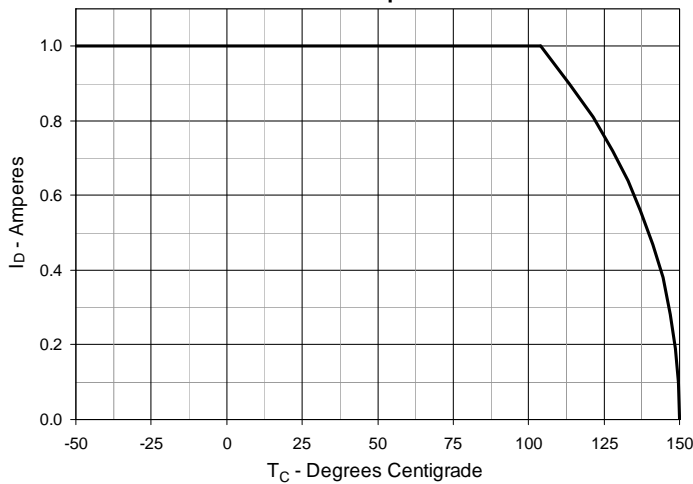

Fig. 6. Input Admittance

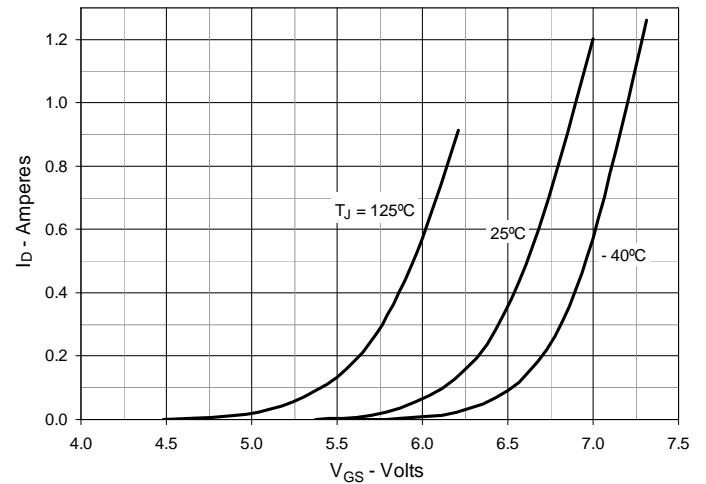

Fig. 7. Transconductance

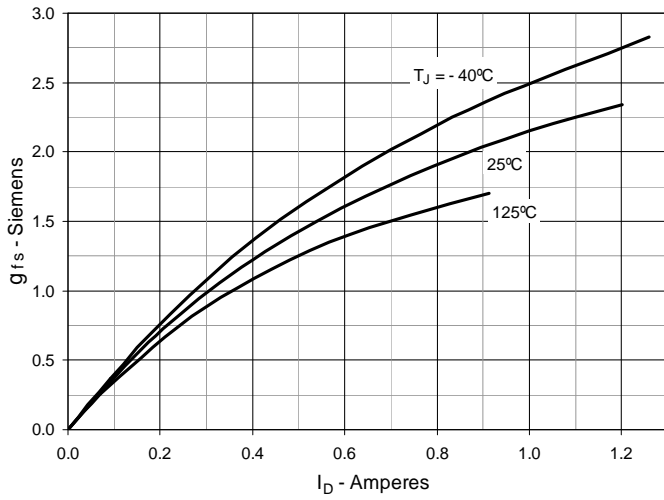

Fig. 8. Forward Voltage Drop of Intrinsic Diode

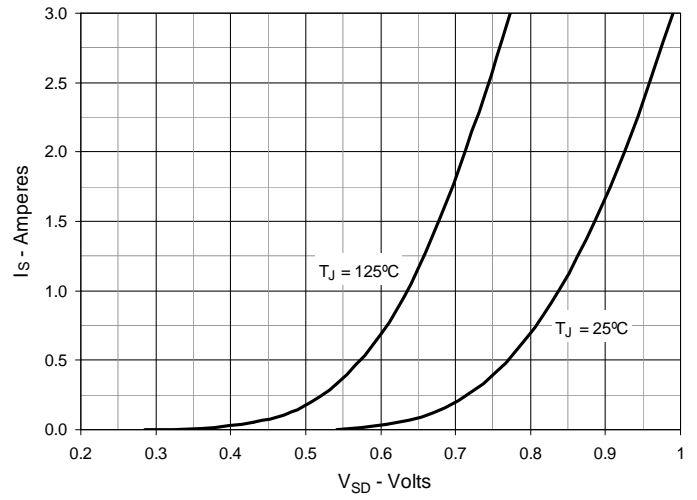

Fig. 9. Gate Charge

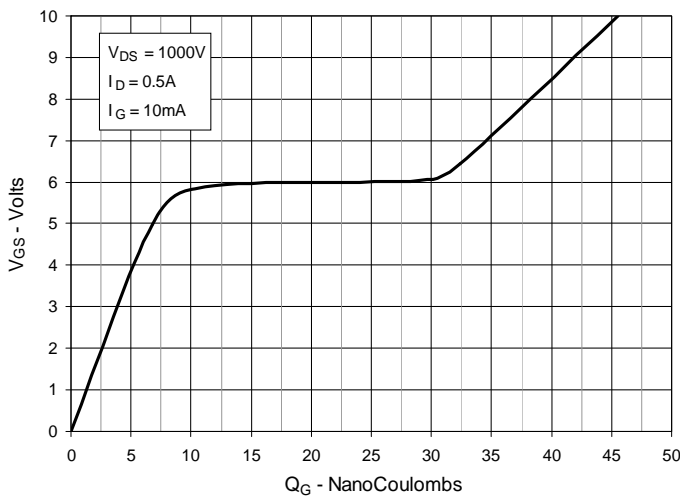

Fig. 10. Capacitance

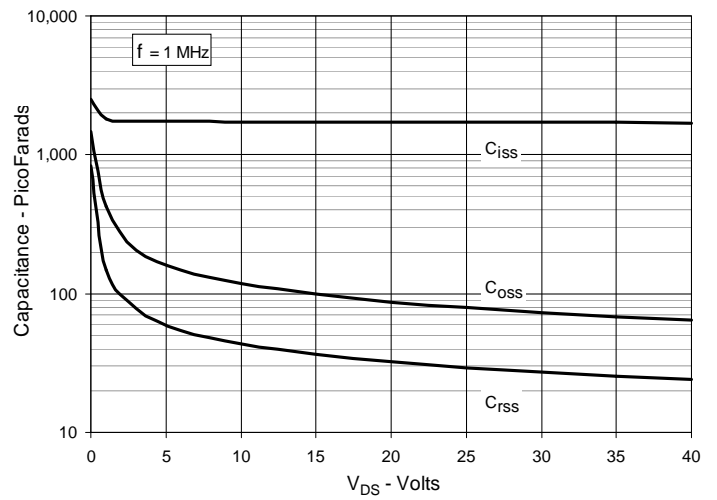

Fig. 11. Maximum Transient Thermal Impedance

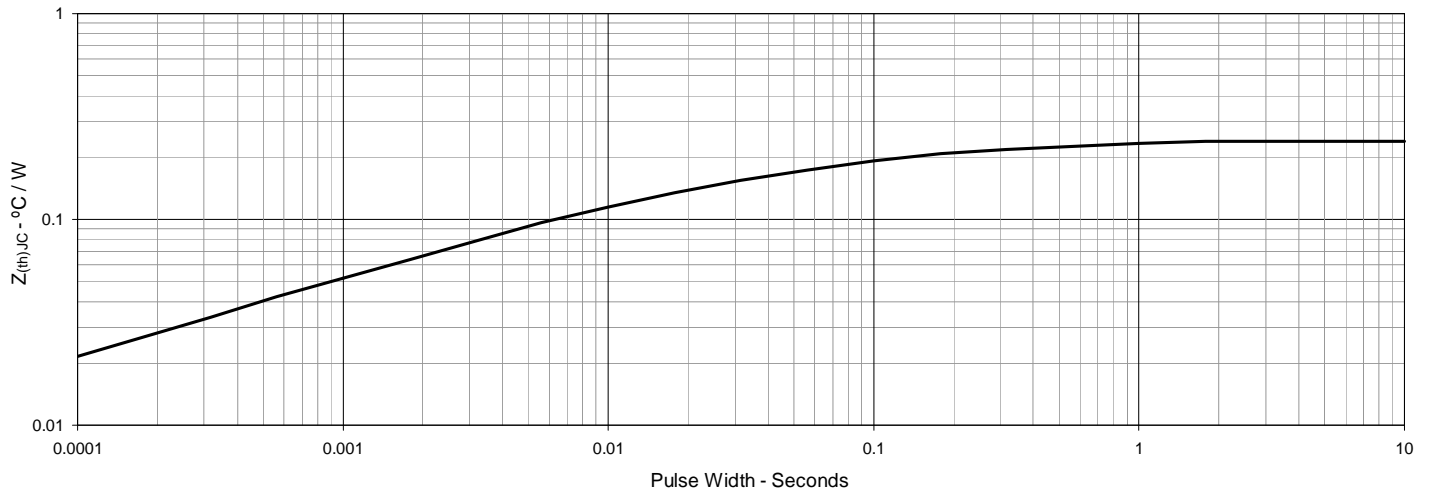

Fig. 12. Forward-Bias Safe Operating Area
@ $T_C = 25^\circ\text{C}$

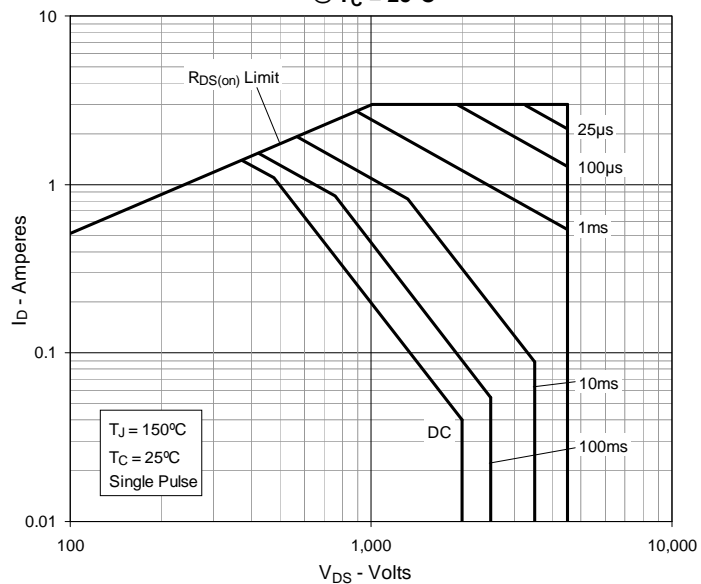
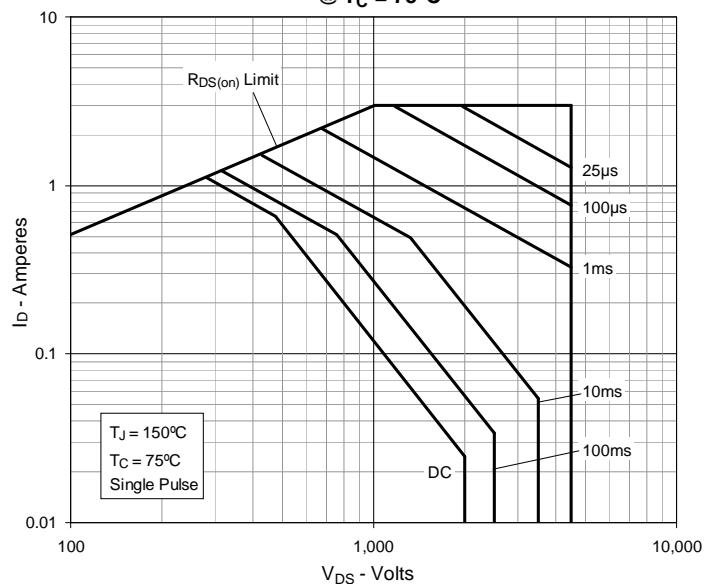

Fig. 13. Forward-Bias Safe Operating Area
@ $T_C = 75^\circ\text{C}$





Disclaimer Notice - Information furnished is believed to be accurate and reliable. However, users should independently evaluate the suitability of and test each product selected for their own applications. Littelfuse products are not designed for, and may not be used in, all applications. Read complete Disclaimer Notice at www.littelfuse.com/disclaimer-electronics.