

1. FIGURE AND DIMENSIONS (视图及尺寸)

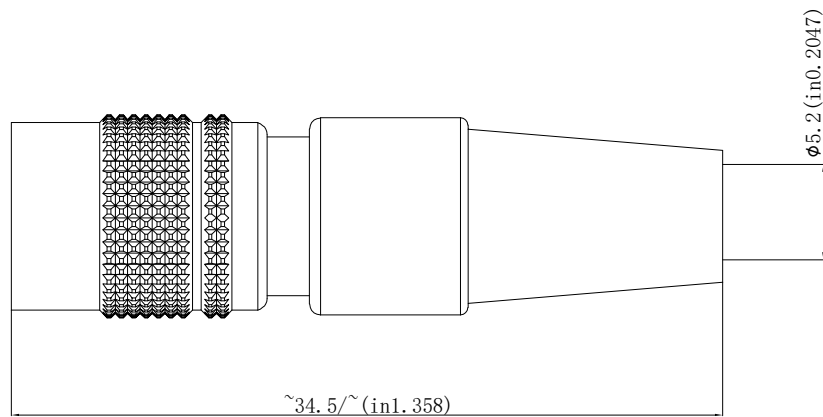
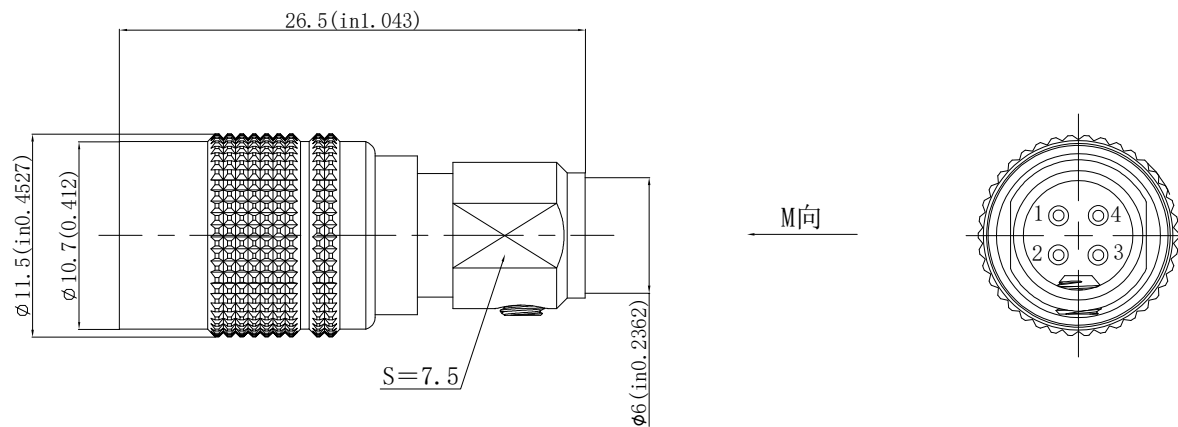

Main technical indicators (主要技术指标)	
1. Mating (插拔次数)	500
2. Working Temperature (温度)	-55~+150 °C
3. IP Rating (防护级别)	IP 44
4. Diameter of socket end (插合端直径)	φ0.6
5. Testing Voltage (测试电压)	150V
7. Rated Current (额定电流)	2A
8. Shell material (壳体材质)	Zinc alloy nickel plated/锌合金镀亚镍
9. Pin Material (插针材料)	Copper alloy gold plating(铜合金镀金)

Sum up (总结)	
Series (系列)	XKB10
Shell style/model (外壳样式/型号)	7R: Straight plug, feed-through type/直式插头, 直通型
Button (按键)	5 button (5个按键)
Termination type (终止类型)	Male solder (公焊锡)
Line diameter awg (线材直径)	22-30AWG
Cable diameter φ (电缆直径)	-
Match plug (匹配插头)	XKB10A. 7R. 4A/XKB10A. 7R. 4AN

版本			TITLE	DRAWING NO.	REV.
REVA4			XKB10A. 7P插头4芯母针	XKB10A-7P-4L	A0
REVA3					
REVA2			PART NO.	UNIT	
REVA1			USE	SCALE	
DRAW		DATE		SHEET	
CHECK		DATE		XKB INDUSTRIAL PRECISION CO., LIMITED	
APPR' D		DATE			