

技术特性/Specifications:

额定电压 Rated voltage: 250V AC, DC
额定电流 Rated current: 3A AC, DC
接触电阻 Contact resistance: 20m Ω max
绝缘电阻 Insulation resistance: 1000M Ω min
耐压 Withstand voltage: 1000V AC/minute
环境温度 Ambient temperature: -40 $^{\circ}$ C~+105 $^{\circ}$ C
适用线规 Wire range: AWG#28~#22

REV.	REVISION DESCRIPTION	DATE	APPD



NOTES

Available in 02 through 20 Circuits.
 Mates with DL25013-Y Series Housing.
 Material : Nylon UL94V-0(2).
 0.7mm Square Pin.
 Pin Material : Brass / Tin-Plated.



Circuits	Type	Dimensino (mm)			Circuits	Type	Dimensino (mm)		
		A	B	C			A	B	C
2	5264-2A	2.5	7.4	6.1	12	5264-12A	27.5	32.4	31.1
3	5264-3A	5.0	9.9	8.6	13	5264-13A	30.0	34.9	33.6
4	5264-4A	7.5	12.4	11.1	14	5264-14A	32.5	37.4	36.1
5	5264-5A	10.0	14.9	13.6	15	5264-15A	35.0	39.9	38.6
6	5264-6A	12.5	17.4	16.1	16	5264-16A	37.5	42.4	41.1
7	5264-7A	15.0	19.9	18.6	17	5264-17A	40.0	44.9	43.6
8	5264-8A	17.5	22.4	21.1	18	5264-18A	42.5	47.4	46.1
9	5264-9A	20.0	24.9	23.6	19	5264-19A	45.0	49.9	48.6
10	5264-10A	22.5	27.4	26.1	20	5264-20A	47.5	52.4	51.1
11	5264-11A	25.0	29.9	28.6					

GENERAL TOLERANCES (UNLESS SPECIFIED)		ZHE JIANG DELI CONNECTORS CO., LTD			
.X: ±0.25	X°: ±3.0°	PRODUCT NAME: DL25013(5264)-A		TITLE: 2.50 mm Pitch Wire To Board Wafer	
.XX: ±0.15	.X°: ±2.0°	DR: Yuan Jun Rong	DATE:21/03/05	PART NO:	
.XXX: ±0.01	.XX°: ±1.0°	CHKD: Liu Bing	DATE:21/03/05	SCALE: N/A	PAGE: 1/1
DRAWING NO:		APPD:Ren An De	DATE:21/03/05	UNITS: mm	REV.: A

REV.	REVISION DESCRIPTION	DATE	APPD



NOTES

Available in 02 through 20 Circuits.
 Mates with DL25013-Y Series Housing.
 Material : Nylon UL94V-0(2).
 0.7mm Square Pin.
 Pin Material : Brass / Tin-Plated.

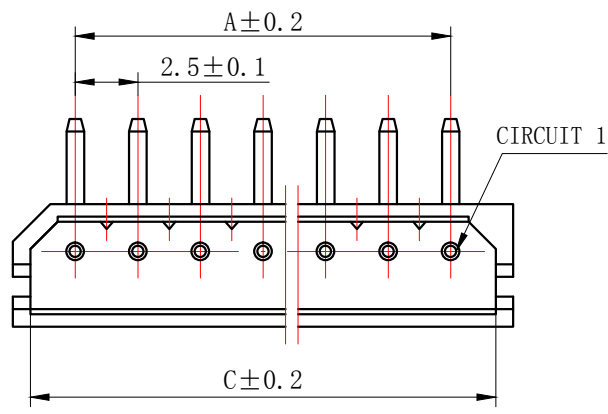

Circuits	Type	Dimensino (mm)			Circuits	Type	Dimensino (mm)		
		A	B	C			A	B	C
2	5264-2AW	2.5	7.4	6.1	12	5264-12AW	27.5	32.4	31.1
3	5264-3AW	5.0	9.9	8.6	13	5264-13AW	30.0	34.9	33.6
4	5264-4AW	7.5	12.4	11.1	14	5264-14AW	32.5	37.4	36.1
5	5264-5AW	10.0	14.9	13.6	15	5264-15AW	35.0	39.9	38.6
6	5264-6AW	12.5	17.4	16.1	16	5264-16AW	37.5	42.4	41.1
7	5264-7AW	15.0	19.9	18.6	17	5264-17AW	40.0	44.9	43.6
8	5264-8AW	17.5	22.4	21.1	18	5264-18AW	42.5	47.4	46.1
9	5264-9AW	20.0	24.9	23.6	19	5264-19AW	45.0	49.9	48.6
10	5264-10AW	22.5	27.4	26.1	20	5264-20AW	47.5	52.4	51.1
11	5264-11AW	25.0	29.9	28.6					

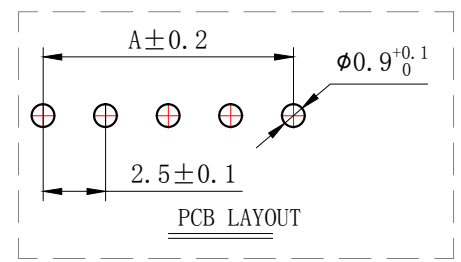

GENERAL TOLERANCES (UNLESS SPECIFIED)		ZHE JIANG DELI CONNECTORS CO., LTD	
.X: ±0.25	X°: ±3.0°	PRODUCT NAME: DL25013 (5264)-AW	TITLE: 2.50 mm Pitch Wire To Board Wafer
.XX: ±0.15	.X°: ±2.0°	DR: Yuan Jun Rong	DATE:21/03/05
.XXX: ±0.01	.XX°: ±1.0°	CHKD: Liu Bing	DATE:21/03/05
FINISH:		APPD:Ren An De	DATE:21/03/05
DRAWING NO:			PART NO:
			SCALE: N/A
			PAGE: 1/1
			UNITS: mm
			REV.: A

REV.	REVISION DESCRIPTION	DATE	APPD

NOTES

Available in 02 through 20 Circuits.
 Mates with DL25013-Y Series Housing.
 Material : Nylon UL94V-0(2).
 0.7mm Square Pin.
 Pin Material : Brass / Tin-Plated.

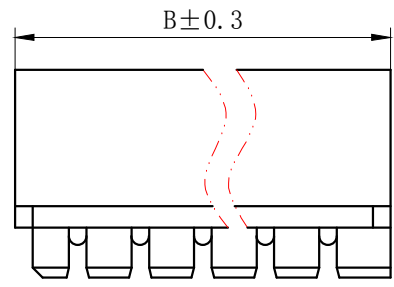

Circuits	Type	Dimensino (mm)			Circuits	Type	Dimensino (mm)		
		A	B	C			A	B	C
2	5264-2AWD	2.5	7.4	6.1	12	5264-12AWD	27.5	32.4	31.1
3	5264-3AWD	5.0	9.9	8.6	13	5264-13AWD	30.0	34.9	33.6
4	5264-4AWD	7.5	12.4	11.1	14	5264-14AWD	32.5	37.4	36.1
5	5264-5AWD	10.0	14.9	13.6	15	5264-15AWD	35.0	39.9	38.6
6	5264-6AWD	12.5	17.4	16.1	16	5264-16AWD	37.5	42.4	41.1
7	5264-7AWD	15.0	19.9	18.6	17	5264-17AWD	40.0	44.9	43.6
8	5264-8AWD	17.5	22.4	21.1	18	5264-18AWD	42.5	47.4	46.1
9	5264-9AWD	20.0	24.9	23.6	19	5264-19AWD	45.0	49.9	48.6
10	5264-10AWD	22.5	27.4	26.1	20	5264-20AWD	47.5	52.4	51.1
11	5264-11AWD	25.0	29.9	28.6					



GENERAL TOLERANCES (UNLESS SPECIFIED)		ZHE JIANG DELI CONNECTORS CO., LTD			
.X: ± 0.25	X°: ± 3.0°	PRODUCT NAME: DL25013 (5264)-AWD		TITLE: 2.50 mm Pitch Wire To Board Wafer	
.XX: ± 0.15	.X°: ± 2.0°	DR: Yuan Jun Rong	DATE: 21/03/05	PART NO:	
.XXX: ± 0.01	.XX°: ± 1.0°	CHKD: Liu Bing	DATE: 21/03/05	SCALE: N/A	PAGE: 1/1
DRAWING NO:		APPD: Ren An De	DATE: 21/03/05	UNITS: mm	REV.: A

REV.	REVISION DESCRIPTION	DATE	APPD

NOTES

Available in 02 through 20 Circuits.
 Mates with DL25013-A or
 DL25013-AW or DL25013-AWD Series WAFER.

Material : Nylon UL94V-0(2).

Accepts DL25013-T Crimp Terminal.

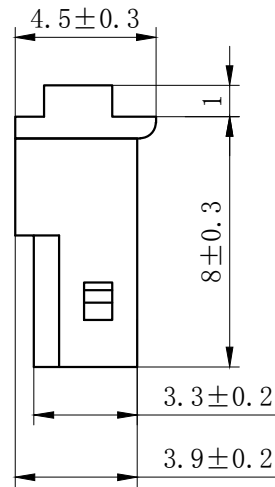
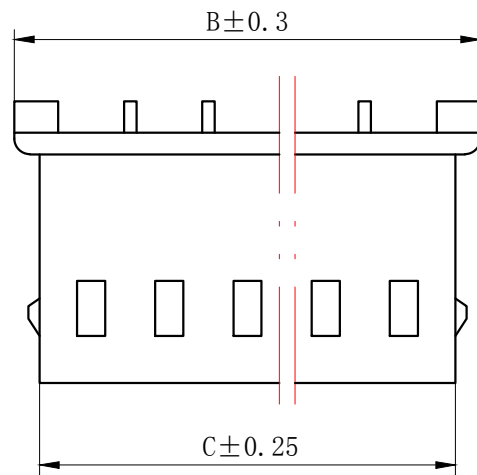
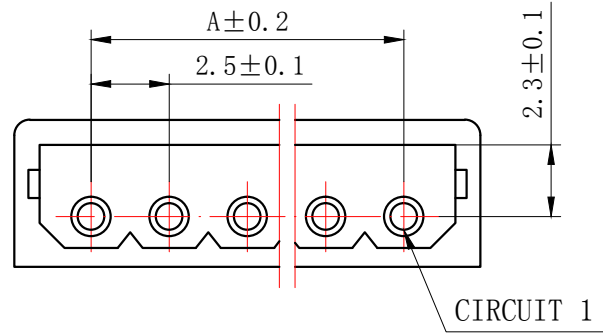

Circuits	Type	Dimensino (mm)			Circuits	Type	Dimensino (mm)		
		A	B	C			A	B	C
2	5264-2Y	2.50	7.50	5.80	12	5264-12Y	27.50	32.50	30.80
3	5264-3Y	5.00	10.00	8.30	13	5264-13Y	30.00	35.00	33.30
4	5264-4Y	7.50	12.50	10.80	14	5264-14Y	32.50	37.50	35.80
5	5264-5Y	10.00	15.00	13.30	15	5264-15Y	35.00	40.00	38.30
6	5264-6Y	12.50	17.50	15.80	16	5264-16Y	37.50	42.50	40.80
7	5264-7Y	15.00	20.00	18.30	17	5264-17Y	40.00	45.00	43.30
8	5264-8Y	17.50	22.50	20.80	18	5264-18Y	42.50	47.50	45.80
9	5264-9Y	20.00	25.00	23.30	19	5264-19Y	45.00	50.00	48.30
10	5264-10Y	22.50	27.50	25.80	20	5264-20Y	47.50	52.50	50.80
11	5264-11Y	25.00	30.00	28.30					

GENERAL TOLERANCES (UNLESS SPECIFIED)		ZHE JIANG DELI CONNECTORS CO., LTD	
.X: ±0.25	X°: ±3.0°	PRODUCT NAME: DL25013(5264)-Y	TITLE: 2.50 mm Pitch Housing
.XX: ±0.15	.X°: ±2.0°	DR: Yuan Jun Rong	DATE: 21/03/05
.XXX: ±0.01	.XX°: ±1.0°	CHKD: Liu Bing	DATE: 21/03/05
FINISH:		APPD: Ren An De	DATE: 21/03/05
DRAWING NO:		SCALE: N/A	PAGE: 1/1
		UNITS: mm	REV.: A

REV.	REVISION DESCRIPTION	DATE	APPD

NOTES

Used in DL25013-Y Series Housing.
 Accepts AWG #28~22 Wire Range.
 0.06~ 0.33 mm² .
 Insulation O.D.=1.2~1.9 mm.
 Material : Phosphor Bronze .
 Finish: Tin plated.
 Thickness: 0.2 mm.

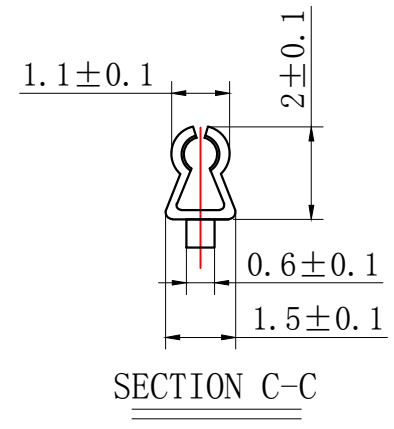
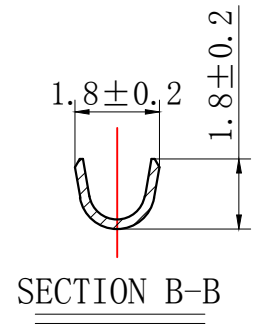
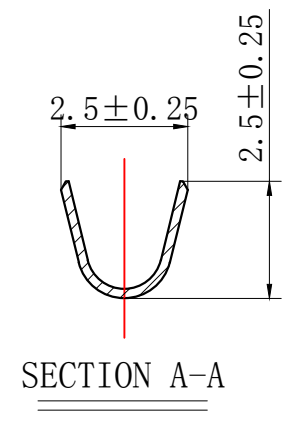

GENERAL TOLERANCES (UNLESS SPECIFIED)		ZHE JIANG DELI CONNECTORS CO., LTD	
.X: ± 0.25	X°: ± 3.0°	PRODUCT NAME: DL25013 (5264)-T	TITLE: 2.50 mm Pitch Crimp Terminal
.XX: ± 0.15	.X°: ± 2.0°	DR: Yuan Jun Rong	DATE: 21/08/01
.XXX: ± 0.01	.XX°: ± 1.0°	CHKD: Wu Hui	DATE: 21/08/01
DRAWING NO:		APPD: Ren An De	DATE: 21/08/01
		SCALE: N/A	PAGE: 1/1
		UNITS: mm	REV.: A