

修订 REV A0	标记 MARK	修改摘要 REVISION DESCRIPTION NEW DRG	签名 SIGNATURE	日期 DATE 2016-03-12
-----------------	------------	---	-----------------	--------------------------

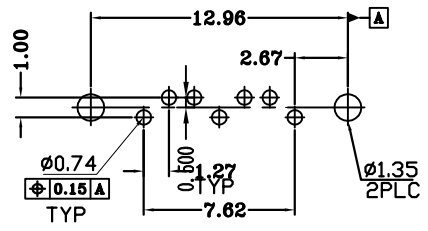

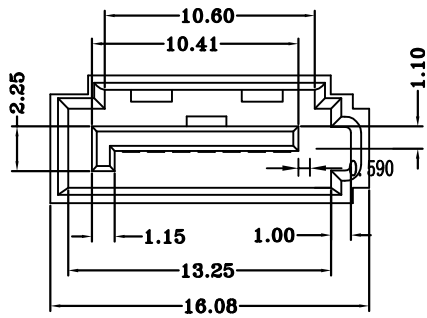
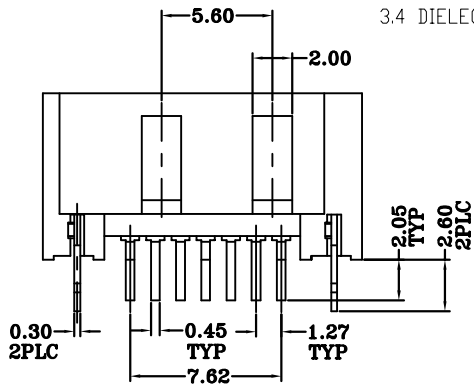
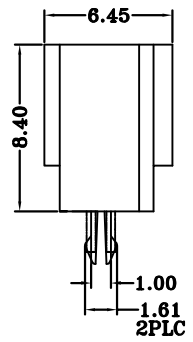
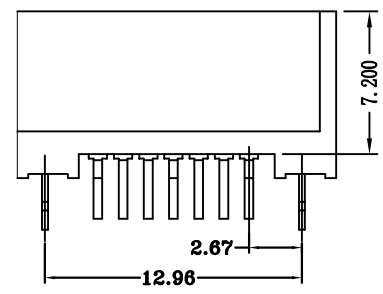

RECOMMEND PCB LAYOUT
PCB TOLERANCE: ±0.05

SPECIFICATION:
 1.MATERIAL:
 HOUSING:LCP 30% G/F UL 94V-0 or PA46 UL 94V-0
 COLOR:BLACK
 CONTACT:C5191-H,T=0.25mm
 2.FINISH:
 CONTACT:1u"or15u"
 / GOLD/TIN PLATING ON CONTACT AREA
 100u" MIN. TIN-LEAD PLATING ON SOLDER TAILS
 50u" MIN.NICKEL UNDERPLATING OVER ALL
 3.ELECTRICAL
 3.1 CURRENT RATING: 1.5A PER PIN MIN.
 3.2 CONTACT RESISTANCE: 30m OHM MAX.
 3.3 INSULATION RESISTANCE: 500M OHM MIN.
 3.4 DIELECTRIC WITHSTANDING VOLTAGE: 500VAC.



由 Autodesk 教育版产品制作

 深圳市华德共创科技有限公司 Shenzhen Huade co-create Technology Co.,LTD 电话: 0755-27111216 传真: 0755-29940187								
-TOLERANCES- UNLESS OTHERWISE SPECIFIED 公差参数表		 	TITLE: SATA 7P A型180度DIP全包 产品名称: 鱼叉脚					
X.X	±0.30	X.X°	±3°	APPD: 核准:	PART NO: 产品编号: HDGCYLSY-SATA-114			
X.XX	±0.20	X.XX°	±2°	CHECK: 校对: 王建业	DATE	SCALE	UNIT	CODE NUMBER
X.XXX	±0.10	X.XXX°	±1°	DRAW: 绘图: 黄艳兰	2016-03-12	1:1	mm	A001

由 Autodesk 教育版产品制作