

WGC3997

Features:

- High Switching Speed
- High Breakdown Voltage- $V_{(BR)CBO}=1200V(\text{Min})$
- Minimum Lot-to-Lot variations for robust device performance and reliable operation

TO-264 

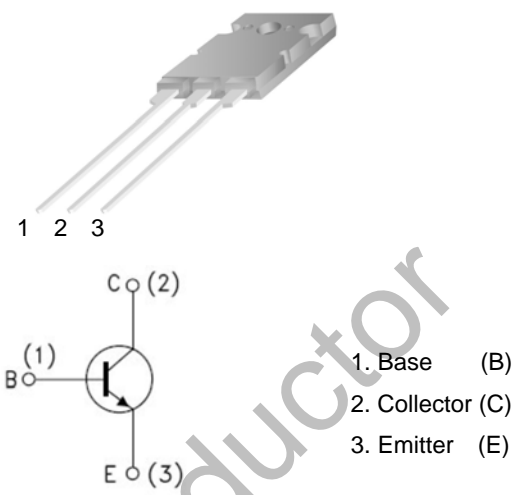

1. Base (B)
2. Collector (C)
3. Emitter (E)

Absolute Maximum Ratings $T_C=25^\circ\text{C}$ unless otherwise noted

Symbol	Parameter	Rating	Units
V_{CBO}	Collector-Base Voltage	1200	V
V_{CEO}	Collector-Emitter Voltage	800	V
V_{EBO}	Emitter-Base Voltage	6	V
I_C	Collector Current (DC)	20	A
I_{CP}^*	Collector Current (Pulse)	30	A
P_C	Collector Dissipation	200	W
T_J	Junction Temperature	150	$^\circ\text{C}$
T_{STG}	Storage Temperature	-55 ~ 150	$^\circ\text{C}$

* Pulse Test: $PW=300\mu\text{s}$, duty Cycle=2% Pulsed

Electrical Characteristics $T_C=25^\circ\text{C}$ unless otherwise noted

Symbol	Parameter	Test Conditions	Min.	Typ.	Max.	Units
I_{CES}	Collector Cut-off Current	$V_{CB}=1400V, R_{BE}=0$			1	mA
I_{CBO}	Collector Cut-off Current	$V_{CB}=800V, I_E=0$			10	μA
I_{EBO}	Emitter Cut-off Current	$V_{EB}=4V, I_C=0$			1	mA
BV_{CBO}	Collector-Base Breakdown Voltage	$I_C=500\mu\text{A}, I_E=0$	1200			V
BV_{CEO}	Collector-Emitter Breakdown Voltage	$I_C=5\text{mA}, I_B=0$	800			V
BV_{EBO}	Emitter-Base Breakdown Voltage	$I_E=500\mu\text{A}, I_C=0$	6			V
h_{FE1} h_{FE2}	DC Current Gain	$V_{CE}=5V, I_C=1A$ $V_{CE}=5V, I_C=11A$	8 5.5		8.5	
$V_{CE(\text{sat})}$	Collector-Emitter Saturation Voltage	$I_C=11A, I_B=2.75A$			3	V
$V_{BE(\text{sat})}$	Base-Emitter Saturation Voltage	$I_C=11A, I_B=2.75A$			1.5	V
t_{STG}^*	Storage Time	$V_{CC}=200V, I_C=10A, R_L=20\Omega$			3	μs
t_F^*	Fall Time	$I_{B1}=2.0A, I_{B2}= -4.0A$		0.15	0.2	μs

* Pulse Test: $PW=20\mu\text{s}$, duty Cycle=1% Pulsed

Thermal Characteristics $T_C=25^\circ\text{C}$ unless otherwise noted

Symbol	Parameter	Typ	Max	Units
$R_{\theta JC}$	Thermal Resistance, Junction to Case		0.625	$^\circ\text{C/W}$

Typical Characteristics

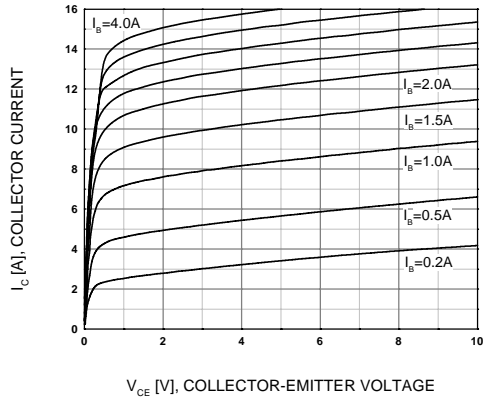

Figure 1. Static Characteristics

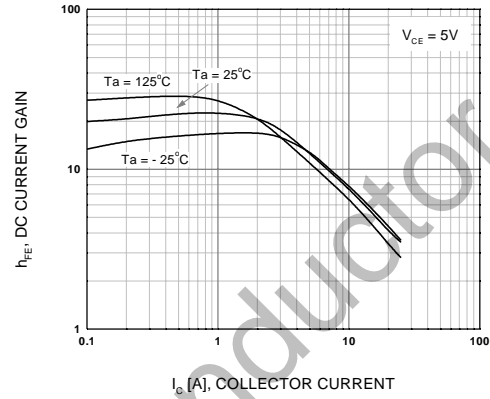

Figure 2. DC Current Gain

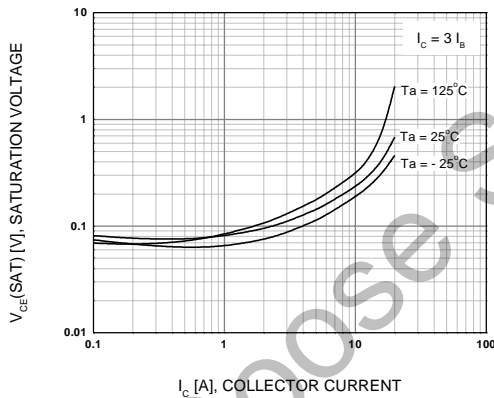

Figure 3. Collector-Emitter Saturation Voltage

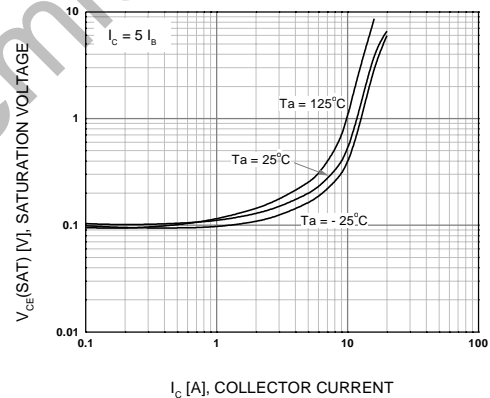

Figure 4. Collector-Emitter Saturation Voltage

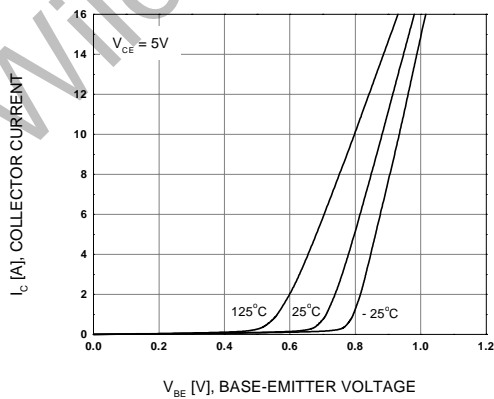

Figure 5. Base-Emitter On Voltage

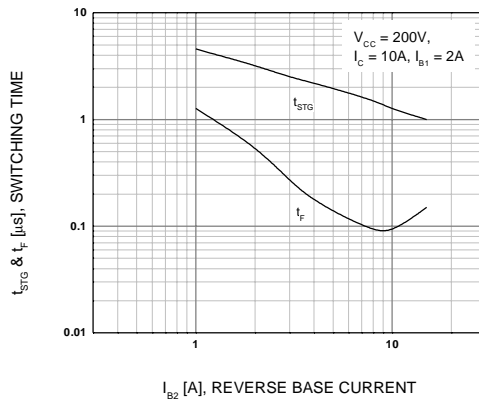

Figure 6. Resistive Load Switching Time

Typical Characteristics (Continued)

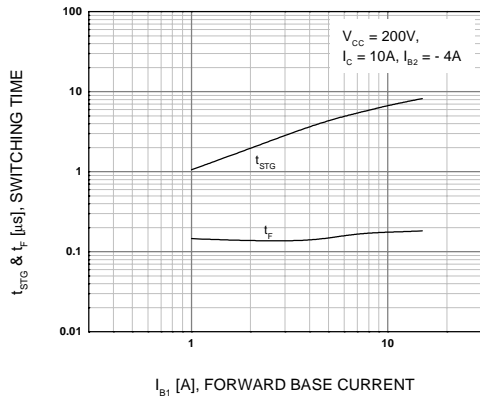

Figure 7. Resistive Load Switching Time

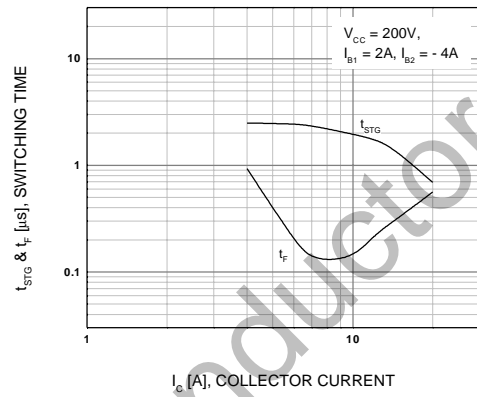

Figure 8. Resistive Load Switching Time

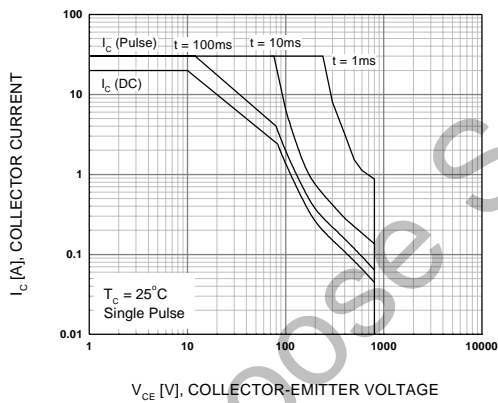

Figure 9. Forward Bias Safe Operating Area

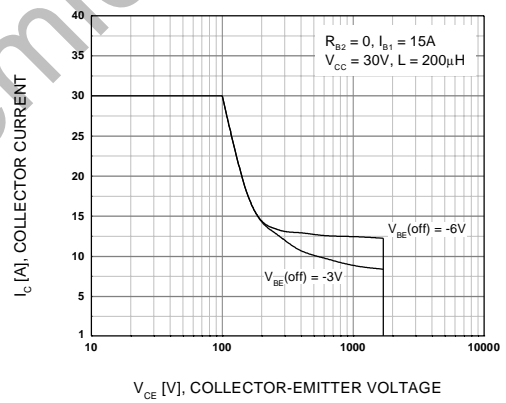

Figure 10. Reverse Bias Safe Operating Area

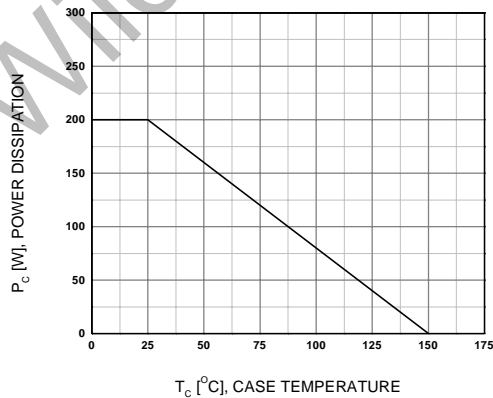

Figure 11. Power Derating

Package Dimension

TO-264

Unit: mm

