

Pin layout

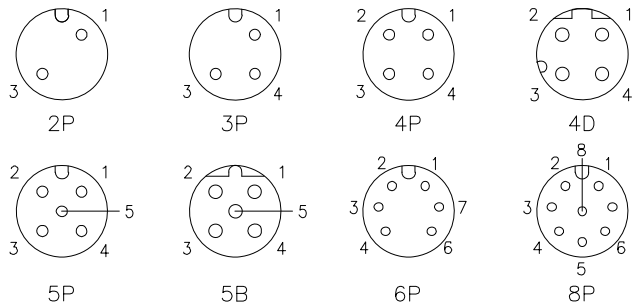

Technical specifications:

Coupling: Threaded coupling  
 Termination: screw  
 Pollution degree: 3  
 Temperature range: -20°C ~ +80°C  
 Degree of protection: IP67 when mated  
 Mating cycles: ≥500  
 Suitable cable Dia: A:4~6mm;B:6~8mm  
 Wire gauge: 2~5Pin:AWG22; 6~8Pin:AWG24

Materials:

Contact: Brass  
 Contact plating: Gold plated  
 Contact insert: TPU Black  
 Base shell: Zinc nickel plated  
 Hex nut: Brass nickel plated  
 Seal: NBR

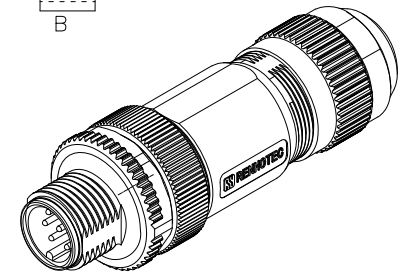
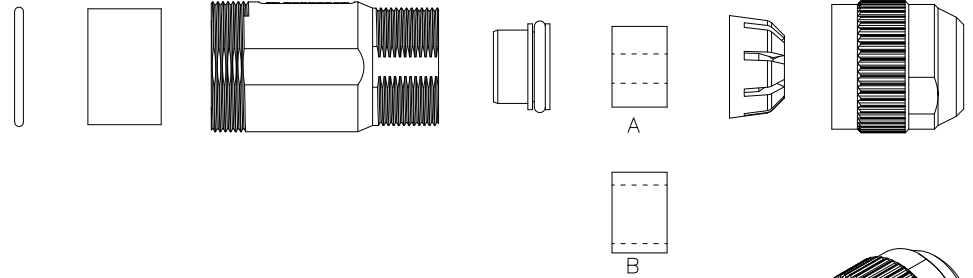
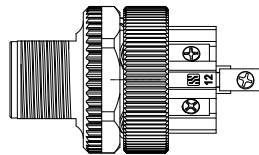
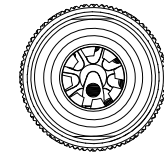
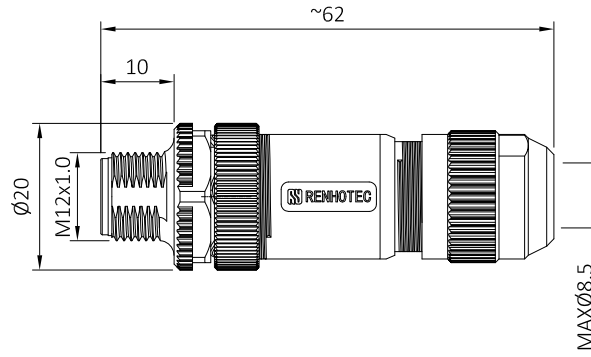
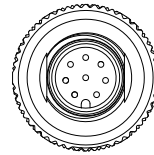

PIN	2	3	4	4D	5	5B	6	8
Rated voltage/ Current	4A/250V	4A/250V	4A/250V	4A/250V	4A/60V	4A/60V	2A/30V	2A/30V
Rated pulse voltage	2500V	2500V	2500V	2500V	1500V	1500V	800V	800V
Insulation resistance (MΩ)	≥ 100	≥ 100	≥ 100	≥ 100	≥ 100	≥ 100	≥ 100	≥ 100
Contact resistance (mΩ)	≤ 5	≤ 5	≤ 5	≤ 5	≤ 5	≤ 5	≤ 5	≤ 5

-TOLERANCES- UNLESS OTHERWISE SPECIFIED	DOSIN INDUSTRIAL(HK)CO.,LTD 江门市德索连接器有限公司 Jiangmen Dosin Connector Co., LTD Web: <a href="https://www.dosinconn.cn/">https://www.dosinconn.cn/</a> Mailbox: <a href="mailto:sale@dosin.cn">sale@dosin.cn</a> Tel: (0086)769-81153906				
	PART DESCRIPTION: M12 Male connector,Assembly,Shielded				
	Appr: JIM.KING		P/N: DS869MCS0439		
	Check:	Date: 2023.08.08	Scale: Free	Unit: MM	Type: Z
UNLESS OTHERWISE SPECIFIED TOLERANCES FOR MILLIMETERS ARE: 0.5 - 8mm ± 0.20mm 8 - 30mm ± 0.25mm 30 - 120mm ± 0.30mm		Draw: DING			