

Datasheet – SHT4x

4th Gen. Relative Humidity and Temperature Sensor

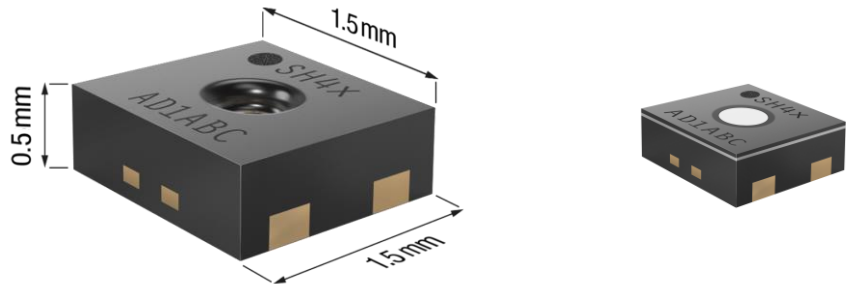

Highlights

- Accuracies $\Delta RH = \pm 1.0\%RH$, $\Delta T = \pm 0.1\text{ }^\circ C$
- VDD = 1.08 V ... 3.6 V
- Avg. current: 0.4 μA , Idle current: 80 nA
- I2C FM+, CRC checksum, multip. I2C addr.
- Patented protection options [1], PTFE membrane and removable protective cover
- Operating range: 0 ... 100 %RH, -40...125 $^\circ C$
- Fully functional in a condensing environment
- Power heater, true NIST-traceability
- JEDEC JESD47 qualification
- Sensor-specific calibration certificate acc. to ISO 17025: 2017, 3-point temp. calibration

SHT4x is a digital sensor platform for measuring relative humidity and temperature at different accuracy classes. Its I2C interface provides several preconfigured I2C addresses while maintaining an ultra-low power budget (0.4 μW). The power-trimmed internal heater can be used at three heating levels thus enabling sensor operation in demanding environments. The four-pin dual-flat-no-leads package is suitable for surface mount technology (SMT) processing and comprises an optional on-package patented PTFE [1] membrane or a removable protective cover. Sensor specific calibration certificates according to ISO17025, identifiable through unique serial numbers, are available.

Device Overview

Product	Details
SHT40-AD1B	base RH&T accur., 0x44 I2C addr.
SHT40-BD1B	base RH&T accur., 0x45 I2C addr.
SHT40-AD1F	SHT40-AD1B with PTFE membrane
SHT40-AD1P	SHT40-AD1B with protective cover
SHT41-AD1B	intermed. RH&T accur., 0x44 I2C addr.
SHT43-ADCB	ISO17025 3-point calibration certificate
SHT45-AD1B	$\pm 1.0\%RH$, $\pm 0.1\text{ }^\circ C$ accur., 0x44 I2C addr.

See full product list on page 21.

Functional Block Diagram

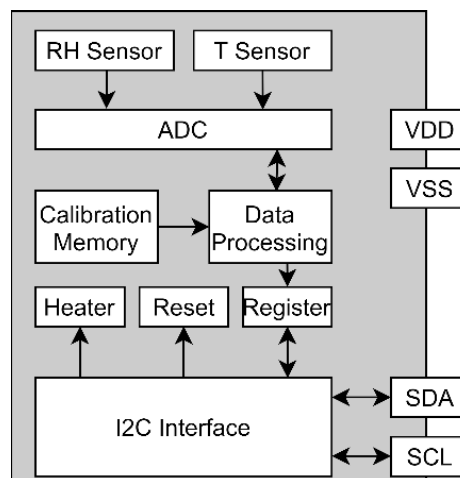

Scan me to provide feedback

Contents

1	Quick Start Guide.....	3
2	Sensor Specifications	4
2.1	Relative Humidity	4
2.1.1	Relative Humidity Accuracy at the Extended Temperature Range	5
2.2	Temperature.....	6
2.3	Recommended Operating Conditions.....	7
2.4	ISO17025 certification with 3-point calibration data.....	7
2.5	Design In.....	8
3	Electrical Specifications	9
3.1	Timings.....	10
3.2	Absolute Maximum Ratings.....	10
4	Sensor Operation.....	10
4.1	I2C Communication.....	10
4.2	I2C Communication Timing	11
4.3	Data type & length.....	11
4.4	Checksum Calculation	11
4.5	Command Overview.....	12
4.6	Conversion of Signal Output.....	12
4.7	Serial Number.....	13
4.8	Reset & Abort.....	13
4.9	Heater Operation	13
5	Physical Specification	14
5.1	Package Description.....	14
5.2	Package Outline.....	14
5.3	Land Pattern.....	15
5.4	Pin Assignment & Laser Marking	16
5.5	Thermal Information	16
6	Protection Options.....	16
6.1	Membrane Option	16
6.2	Protective Cover	17
7	Quality and Material Contents	18
8	Tape and Reel Packaging	18
9	Nomenclature	20
10	Ordering Information.....	21
11	Bibliography.....	21
12	Revision History.....	22

1 Quick Start Guide

A typical application circuit for SHT4x is shown on the left-hand side of **Figure 1**. After reaching the minimal supply voltage and allowing for the maximal power-up time of 1 ms the sensor is ready for I2C communication. The quickest way to measure humidity and temperature is pseudo-coded on the right-hand side of **Figure 1**. Together with the conversion formulae given in equations (1), (2) & (3) the digital signals can be translated into relative humidity and temperature readings.

Typical application circuit

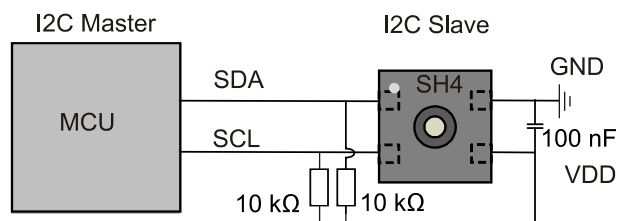

Pseudo code

```

i2c_write(i2c_addr=0x44, tx_bytes=[0xFD])
wait_seconds(0.01)
rx_bytes = i2c_read(i2c_addr=0x44, number_of_bytes=6)
t_ticks = rx_bytes[0] * 256 + rx_bytes[1]
checksum_t = rx_bytes[2]
rh_ticks = rx_bytes[3] * 256 + rx_bytes[4]
checksum_rh = rx_bytes[5]
t_degC = -45 + 175 * t_ticks/65535
rh_pRH = -6 + 125 * rh_ticks/65535
if (rh_pRH > 100):
    rh_pRH = 100
if (rh_pRH < 0):
    rh_pRH = 0
    
```

Figure 1. Typical application circuit (top) and pseudo code (bottom) for easy starting. For details on the signal cropping in the last four lines see section 4.6.

Find code resources and embedded drivers on: <https://github.com/Sensirion/embedded-sht/releases> 

CAD files are available on SnapEDA:

<https://www.snapeda.com/parts/SHT40-AD1B-R3/Sensirion/view-part/> 

2 Sensor Specifications

Every SHT4x is individually tested and calibrated and is identifiable by its unique serial number (see section 4.7 for details on the serial number). For the calibration, Sensirion uses transfer standards, which are subject to a scheduled calibration procedure. The calibration of the reference, used for the calibration of the transfer standards, is NIST traceable through an ISO/IEC 17025 accredited laboratory.

2.1 Relative Humidity

Parameter	Conditions	Value	Units
SHT40 RH accuracy ¹	typ.	±1.8	%RH
	max.	See Figure 2	-
SHT41 RH accuracy ¹	typ.	±1.8	%RH
	max.	See Figure 3	-
SHT43 RH accuracy ¹		±1.8	%RH
		See Figure 4	
SHT45 RH accuracy ¹	typ.	±1.0	%RH
	max.	See Figure 5	-
Repeatability ^{2,3}	high	0.08	%RH
	medium	0.15	%RH
	low	0.25	%RH
Resolution ⁴	-	0.01	%RH
Hysteresis	At 25 °C	±0.8	%RH
Specified range ⁵	extended ⁶	0 to 100	%RH
Response time ⁷	$\tau_{63\%}$	4	s
Long-term drift ⁸	typ.	<0.2	%RH/y

Table 1. General relative humidity sensor specifications.

¹ For definition of typ. and max. accuracy, please refer to the document “Sensirion Humidity Sensor Specification Statement”.

² The stated repeatability is three times the standard deviation (3σ) of multiple consecutive measurement values at constant conditions and is a measure for the noise on the physical sensor output. Different repeatability commands are listed in **Table 8**

³ Valid for 25 °C and 50 %RH.

⁴ Resolution of A/D converter.

⁵ Specified range refers to the range for which the humidity or temperature sensor specification is guaranteed.

⁶ For details about recommended humidity and temperature operating range, please refer to section 2.3.

⁷ Time for achieving 63% of a humidity step function, measured at 25 °C and 1 m/s airflow. Humidity response time in the application depends on the design-in of the sensor.

⁸ Typical value for operation in normal RH/T operating range. Value may be higher in environments with vaporized solvents, out-gassing tapes, adhesives, packaging materials, etc. For more details please refer to Handling Instructions.

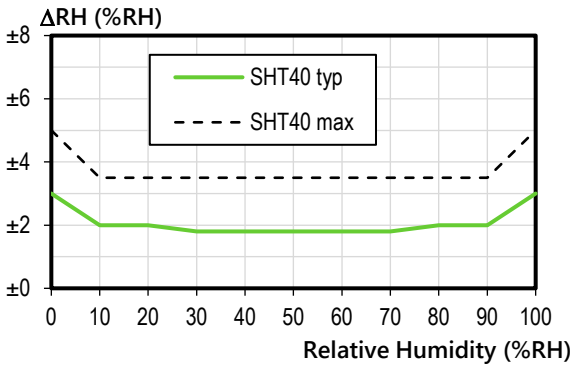

Figure 2. SHT40 typical and maximal relative humidity accuracy at 25 °C.

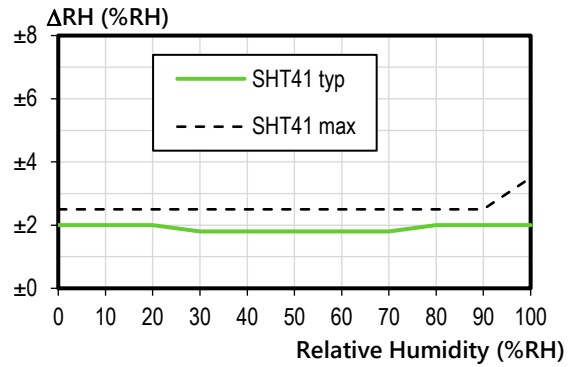

Figure 3. SHT41 typical and maximal relative humidity accuracy at 25 °C.

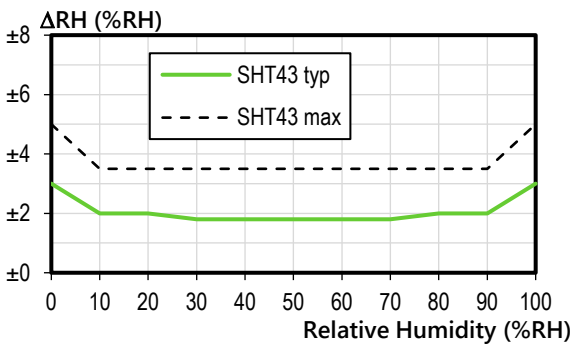

Figure 4. SHT43 typical and maximal relative humidity accuracy at 25 °C.

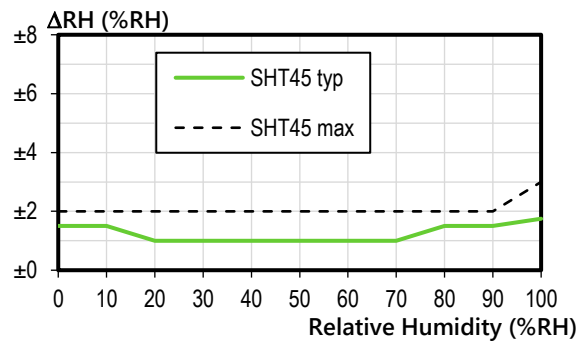

Figure 5. SHT45 typical and maximal relative humidity accuracy at 25 °C.

2.1.1 Relative Humidity Accuracy at the Extended Temperature Range

The typical RH accuracy tolerances in the range of T = 0 °C ... 80 °C are given in **Figure 6**, **Figure 7**, **Figure 8**, and **Figure 9**. **Figure 10**

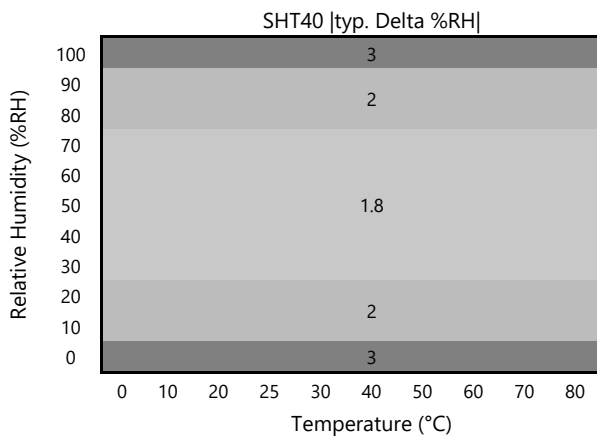

Figure 6. Typical RH accuracy tolerance over humidity and temperature for SHT40.

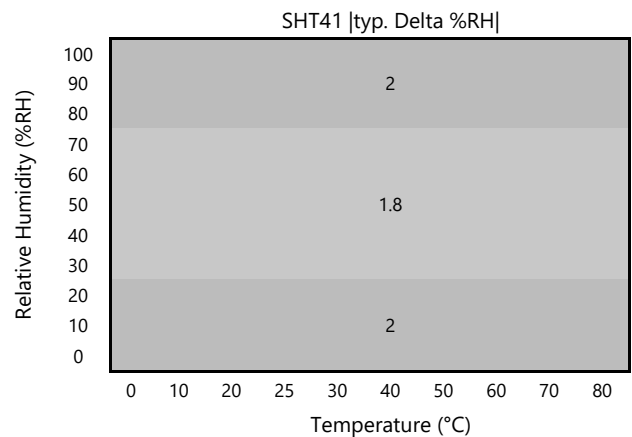

Figure 7. Typical RH accuracy tolerance over humidity and temperature for SHT41.

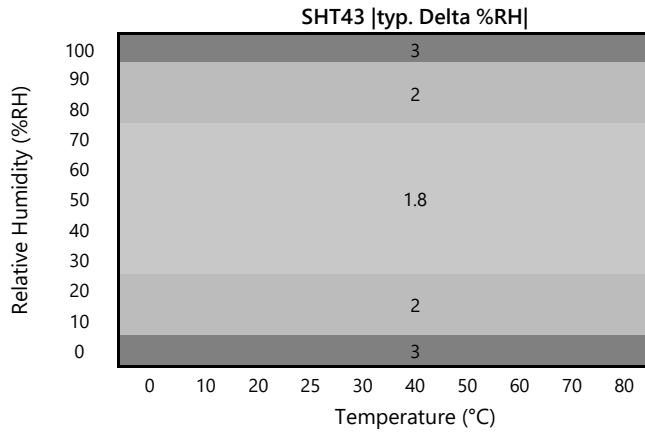

Figure 8. Typical RH accuracy tolerance over humidity and temperature for SHT43.

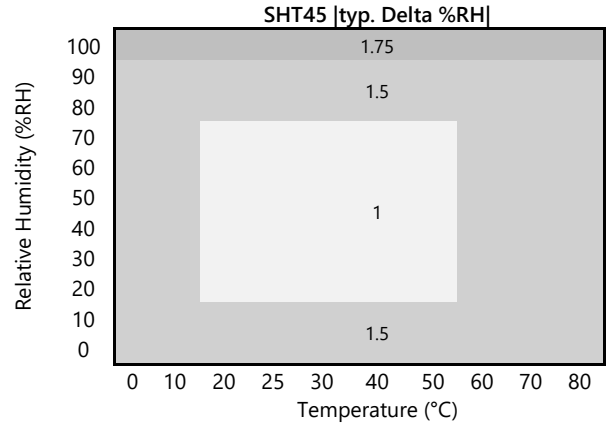

Figure 9. Typical RH accuracy tolerance over humidity and temperature for SHT45.

2.2 Temperature

Parameter	Conditions	Value	Units
SHT40 T Accuracy ¹	typ.	±0.2	°C
	max.	see Figure 10	-
SHT41 T Accuracy ¹	typ.	±0.2	°C
	max.	see Figure 11	-
SHT43 T Accuracy ¹	max.	see Figure 12	-
SHT45 T Accuracy ¹	typ.	±0.1	°C
	max.	see Figure 13	-
Repeatability ²	high	0.04	°C
	medium	0.07	°C
	low	0.1	°C
Resolution ⁴	-	0.01	°C
Specified range ⁵	-	-40 to +125	°C
Response time ⁹	$\tau_{63\%}$	2	s
Long-term drift ¹⁰	typ.	<0.03	°C/y
Long-term drift for SHT43	typ.	<0.01	°C/y

Table 2. General Temperature Sensor specifications.

⁹ Temperature response time depends on heat conductivity of sensor substrate and design-in of sensor in application.

¹⁰ Max. value is <0.04 °C/y. And please note that it is different for the SHT43.

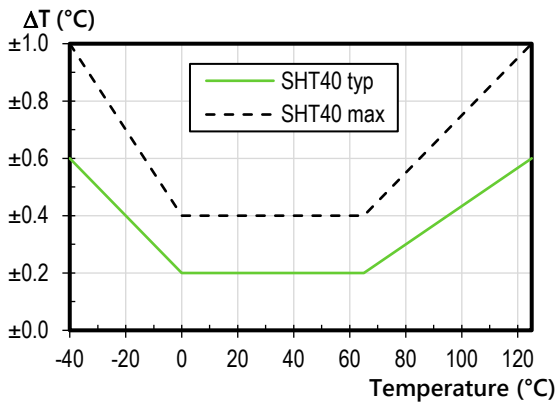

Figure 10. SHT40 typical and maximal temperature accuracy.

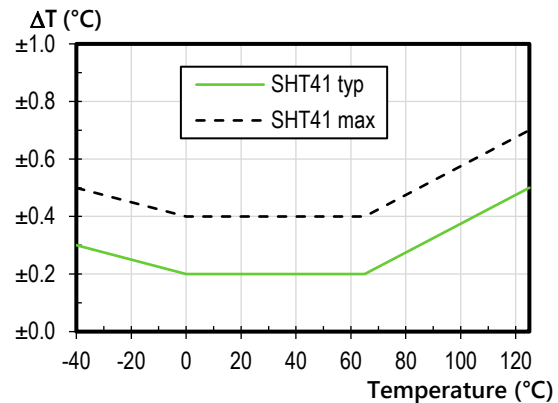

Figure 11. SHT41 typical and maximal temperature accuracy.

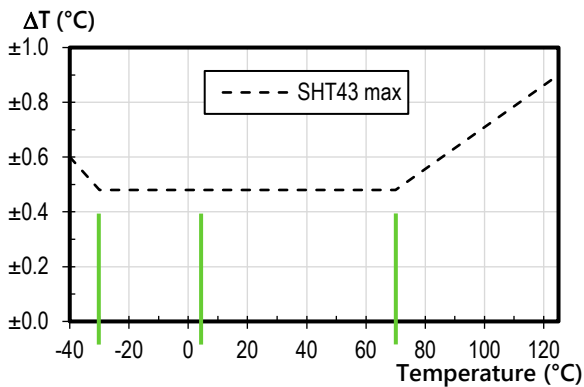

Figure 12. SHT43 maximal temperature accuracy. The green lines represent the calibration points for ISO-17025 certification.

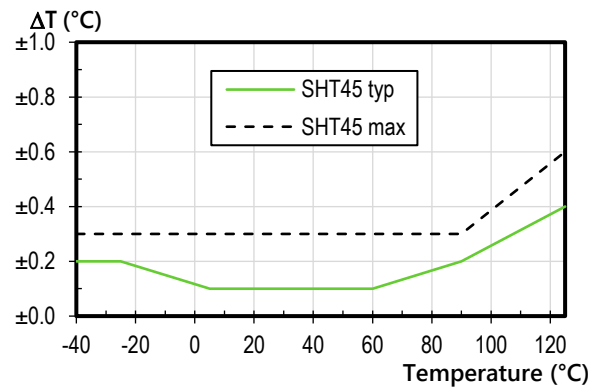

Figure 13. SHT45 typical and maximal temperature accuracy.

2.3 Recommended Operating Conditions

The sensor shows best performance when operated within the recommended normal temperature and humidity range of 5 °C ... 60 °C and 20 %RH ... 80 %RH, respectively. Long term exposure to conditions outside recommended normal range, especially at high relative humidity, may temporarily offset the RH signal (e.g. +3 %RH after 60 h at >80 %RH). After returning into the recommended normal temperature and humidity range the sensor will recover to within specifications by itself. Prolonged exposure to extreme conditions may accelerate ageing.

Even though the Sensors from Sensirions SHT4x Family show exceptional resistance to volatile organic compounds and ageing, the conditions described in the document "Handling Instructions for humidity Sensors" [2] must be met. Please note that this does apply not only to transportation and manufacturing, but also to operation of the SHT4x.

2.4 ISO17025 certification with 3-point calibration data

All SHT43 can be uniquely identified by their serial number (read out command see paragraph 4.7). For each sensor an individual 3-point calibration is performed, accredited to ISO/IEC 17025:2017. The accreditation is performed and granted by the Swiss Accreditation Service (SAS), a public institution of the Swiss Government. The accreditation is documented on the SAS website under the name SCS 0158 and can be

downloaded from this [link](#)¹¹. The three calibration temperatures are T = -30 °C, T = 5 °C, and T = 70 °C. Measurement uncertainties and decision rules according to the SAS are given in Table 3. Metrological traceability of the calibration is in accordance to ch. 6.5 of ISO/IEC 17025:2017, encompassing but not limited to NIST traceability or traceability to other national metrology institutes, according to the CIPM Mutual Recognition Arrangement (CIPM MRA). Reel-wise calibration certificates and data for each SHT43 can be downloaded from libellus.sensirion.com. This allows for efficient processing by automated systems.

Temperature	Expanded measurement uncertainty (k=2)*	Decision rule
-30 °C	0.40 °C	Shared risk (JCGM 106:2010, 8.2)
5 °C	0.20 °C	Shared risk (JCGM 106:2010, 8.2)
70 °C	0.20 °C	Shared risk (JCGM 106:2010, 8.2)

Table 3. Measurement uncertainty and decision rule for the accredited calibration according to Swiss Accreditation Service (SAS). *Measurement uncertainties represent a confidence level of 95% using a coverage factor of k = 2.

For more information on how Sensirion being the first ISO17025 certified Semiconductor company affects the design of certified tracking find the document Sensirion Certified Smart Tracking on our website www.sensirion.com.

2.5 Design In

The above-mentioned specifications hold for the stand-alone sensing element. To achieve the best performance please consult the document Design in Guide [1] on our website Sensirion.com.

¹¹https://www.sas.admin.ch/sas/en/home/akkreditierteststellen/akkrstellensuchesas.exturl.html/aHR0cHM6Ly9zYXNkYi5jbGllbnRzLmtpaXAuY2gvc2VhcmNoLm/h0bWw=.html?csrfmiddlewaretoken=2le2f1aOTUge9YQ3nuaL0lLEYS980ZMdH60doLdY8Nh1sHC3wpw3YvLLVBezmdRn&lang=en&search_term=0158&accreditation_type=2&submit=Start+search

3 Electrical Specifications

Parameter	Symbol	Conditions	Min	Typ	Max	Unit	Comments
Supply voltage	V_{DD}		1.08	3.3	3.6	V	-
Power-up/down	V_{POR}	Static power supply	0.6	-	1.08	V	-
Slew rate of the supply voltage	$V_{DD, slew}$		-	-	20	V/m s	Voltage changes on the supply between $V_{DD, min}$ and $V_{DD, max}$. Faster slew rates may lead to a reset
Supply current (heater off)	I_{DD}	Idle state	- -	0.08 -	1.0 3.4	μ A	At 25 °C At 125 °C
		Power up	-	50	-	μ A	-
		Measurement	-	320	500	μ A	Current while sensor is measuring
		Avg., high repeatability Avg., med. repeatability Avg., low repeatability	- - -	2.2 1.2 0.4	- - -	μ A	Avg. current consumption (continuous operation with 1 meas. per second)
Supply current (heater on)	I_{DD}	Nomin. heater "200 mW"	-	60	100	mA	see section 4.9
		Nomin. heater "110 mW"	-	33	55	mA	
		Nomin. heater "20 mW"	-	6	10	mA	
Power consumpt. at $V_{DD}=1.2$ V (no heater)	-	Avg., high repeatability Avg., med. repeatability Avg., low repeatability	- - -	2.6 1.4 0.5	- - -	μ W	Avg. power consumption (continuous operation with 1 meas. per second)
Low level input voltage	V_{IL}	-	0	-	0.3* V_{DD}	V	-
High level input voltage	V_{IH}	-	0.7* V_{DD}	-	V_{DD}	V	-
Pull up resistors	R_p	$V_{DD} < 1.62$ V	820	-	-	Ω	-
		$V_{DD} \geq 1.62$ V	390	-	-	Ω	-
Low level output voltage	V_{OL}	$V_{DD} < 1.62$ V, $R_{pullup} > 820$ Ω	-	-	0.2* V_{DD}	V	-
		$V_{DD} = 1.62$ V ... 2.0 V, $R_{pullup} > 390$ Ω	-	-	0.2* V_{DD}	V	-
		$V_{DD} > 2.0$ V, $R_{pullup} > 390$ Ω	-	-	0.4	V	-
Capacitive bus load	C_b	$R_p \leq 820$ Ω : fast mode	-	-	400	pF	Capacitive bus load can be determined from $C_b < t_{rise} / (0.8473 * R_p)$. Rise times are $t_{rise} = 300$ ns for fast mode & $t_{rise} = 120$ ns for fast mode plus
		$R_p = 390$ Ω , $V_{DD} > 1.62$ V: fast mode plus	-	-	340	pF	

Table 4. Electrical specifications.

3.1 Timings

Max. values are measured at -40 °C and 1.08 V supply voltage (based on characterization).

Parameter	Symbol	Conditions	Min.	Typ.	Max.	Units	Comments
Power-up time	t_{PU}	After hard reset, $V_{DD} \geq V_{POR}$	-	0.3	1	ms	Time between V_{DD} reaching V_{POR} and sensor entering idle state
Soft reset time	t_{SR}	After soft reset	-	-	1	ms	Time between ACK of soft reset command and sensor entering idle state. Also valid for I2C general call reset.
Measurement duration	$t_{MEAS,l}$	Low repeatability	-	1.3	1.6	ms	Including t_{PU} : The three repeatability modes differ with respect to measurement duration, noise level and energy consumption
	$t_{MEAS,m}$	Med. repeatability	-	3.7	4.5	ms	
	$t_{MEAS,h}$	High repeatability	-	6.9	8.3	ms	
Heater-on duration	t_{Heater}	Long pulse	0.9	1	1.1	s	After that time the heater is automatically switched off
		Short pulse	0.09	0.1	0.11	s	After that time the heater is automatically switched off

Table 5. System timing specifications

3.2 Absolute Maximum Ratings

Stress levels beyond those listed in **Table 6** may cause permanent damage or affect the reliability of the device. These are stress ratings only and functional operation of the device at these conditions is not guaranteed. Ratings are only tested each at a time.

Parameter	Rating
Max. voltage on any pin	$V_{SS} - 0.3 \text{ V} \dots V_{DD} + 0.3 \text{ V}$
Operating temperature range	-40 °C ... 125 °C
Storage temperature range	-40 °C ... 150 °C
ESD HBM	2 kV
ESD CDM	500 V
Latch up, JEDEC Class II, 125 °C	±100 mA

Table 6. Absolute maximum ratings.

4 Sensor Operation

4.1 I2C Communication

I2C communication is based on NXP's I2C-bus specification and user manual UM10204 [3]. Supported I2C modes are standard, fast mode, and fast mode plus. Data is transferred in multiples of 16-bit words. In order to increase reliability of data transfer, I2C glitch protection is offered in form of 8-bit checksum (cyclic redundancy check = CRC, see section 4.4). All transfers must begin with a start condition (S) and terminate with a stop condition (P). To finish a read transfer, send not acknowledge (NACK) and stop condition (P). Addressing a specific slave device is done by sending its 7-bit I2C address followed by an eighth bit, denoting the communication direction: "zero" indicates transmission to the slave, i.e. "write", a "one" indicates a "read" request. Schematics of the I2C transfer types are sketched in **Figure 14**. The sensor does not support clock-stretching. In case the sensor receives a read header and is still busy with e.g.

measurement or heating, it will return a NACK. Measurement data can only be received once and will be deleted from the sensor’s register after the first acknowledged I2C read header.

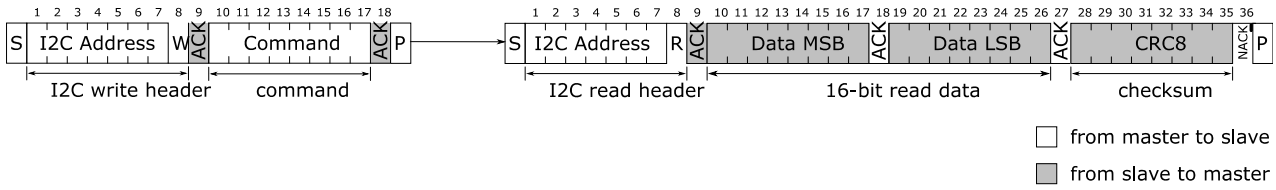

Figure 14. I2C transfer types: First a write header is sent to the I2C slave, followed by a command, for example “measure RH&T with highest precision”. After the measurement is finished the read request directed to this I2C slave will be acknowledged and transmission of data will be started by the slave.

4.2 I2C Communication Timing

All details on the timing are following the interface specification of NXP’s user manual UM10204 [2]. Please follow mandatory capacitor and resistor requirements given in **Table 4**. Please follow mandatory capacitor and resistor requirements given in **Table 4**.

4.3 Data type & length

I2C bus operates with 8-bit data packages. Information from the sensor to the master has a checksum after every second 8-bit data package.

Humidity and temperature data will always be transmitted in the following way: The first value is the temperature signal (2 * 8-bit data + 8-bit CRC), the second is the humidity signal (2 * 8-bit data + 8-bit CRC).

4.4 Checksum Calculation

For read transfers each 16-bit data is followed by a checksum with the following properties.

Property	Value
Name	CRC-8
Message Length	16-bit
Polynomial	0x31 ($x^8 + x^5 + x^4 + 1$)
Initialization	0xFF
Reflect Input/Output	false/false
Final XOR	0x00
Examples	CRC(0xBEEF) = 0x92

Table 7. Data checksum properties

The master may abort a read transfer after the 16-bit data if it does not require a checksum.

4.5 Command Overview

Command (hex)	Response length incl. CRC (bytes)	Description [return values]
0xFD	6	measure T & RH with high precision (high repeatability) [2 * 8-bit T-data; 8-bit CRC; 2 * 8-bit RH-data; 8-bit CRC]
0xF6	6	measure T & RH with medium precision (medium repeatability) [2 * 8-bit T-data; 8-bit CRC; 2 * 8-bit RH-data; 8-bit CRC]
0xE0	6	measure T & RH with lowest precision (low repeatability) [2 * 8-bit T-data; 8-bit CRC; 2 * 8-bit RH-data; 8-bit CRC]
0x89	6	read serial number [2 * 8-bit data; 8-bit CRC; 2 * 8-bit data; 8-bit CRC]
0x94	-	soft reset [ACK]
0x39	6	activate heater with 200mW for 1s, including a high precision measurement just before deactivation [2 * 8-bit T-data; 8-bit CRC; 2 * 8-bit RH-data; 8-bit CRC]
0x32	6	activate heater with 200mW for 0.1s including a high precision measurement just before deactivation [2 * 8-bit T-data; 8-bit CRC; 2 * 8-bit RH-data; 8-bit CRC]
0x2F	6	activate heater with 110mW for 1s including a high precision measurement just before deactivation [2 * 8-bit T-data; 8-bit CRC; 2 * 8-bit RH-data; 8-bit CRC]
0x24	6	activate heater with 110mW for 0.1s including a high precision measurement just before deactivation [2 * 8-bit T-data; 8-bit CRC; 2 * 8-bit RH-data; 8-bit CRC]
0x1E	6	activate heater with 20mW for 1s including a high precision measurement just before deactivation [2 * 8-bit T-data; 8-bit CRC; 2 * 8-bit RH-data; 8-bit CRC]
0x15	6	activate heater with 20mW for 0.1s including a high precision measurement just before deactivation [2 * 8-bit T-data; 8-bit CRC; 2 * 8-bit RH-data; 8-bit CRC]

Table 8. Overview of I2C commands. If the sensor is not ready to process a command e.g. because it is still measuring, it will response with NACK to the I2C read header. Given heater power values are typical and valid for VDD=3.3 V

4.6 Conversion of Signal Output

The digital sensor signals correspond to following humidity and temperature values:

$$RH = \left(-6 + 125 \cdot \frac{S_{RH}}{2^{16} - 1} \right) \%RH \quad (1)$$

$$T = \left(-45 + 175 \cdot \frac{S_T}{2^{16} - 1} \right) ^\circ C \quad (2)$$

$$T = \left(-49 + 315 \cdot \frac{S_T}{2^{16} - 1} \right) ^\circ F \quad (3)$$

N.B.: The RH conversion formula (1) allows values to be reported which are outside of the range of 0 %RH ... 100 %RH. Relative humidity values which are smaller than 0 %RH and larger than 100 %RH are non-physical; however these “uncropped” values might be found beneficial in some cases (e.g. when the distribution of the sensors at the measurement boundaries are of interest). For all who do not want to engage in evaluation of these non-physical values, cropping of the RH signal to the range of 0 %RH ... 100 %RH is advised.

N.B. 2: From a computational perspective, in formulae (1), (2) and (3) the division by $2^{16} - 1$ can be simplified to a division by only 2^{16} . The introduced accuracy deviations are <0.002 %RH and <0.003 °C, respectively.

4.7 Serial Number

Each sensor has a unique serial number, that is assigned by Sensirion during production. It is stored in the one-time-programmable memory and cannot be manipulated after production. The serial number is accessible via I2C command 0x89 and is transmitted as two 16-bit words, each followed by an 8-bit CRC.

4.8 Reset & Abort

A reset of the sensor can be achieved in three ways:

1. Soft reset: send the reset command described in **Table 8**.
2. I2C general call reset: all devices on I2C bus are reset by sending the command 0x06 to the I2C address 0x00.
3. Power down (incl. pulling SCL and SDA low).

Any command that triggers an action at the sensor can be aborted via I2C general call reset or soft reset.

4.9 Heater Operation

The sensor incorporates an integrated on-package heater which can be switched on by the set of commands given in **Table 8**. Three heating powers and two heating durations are selectable. After reception of a heater-on command, the sensor executes the following procedure:

1. The heater is enabled, and the timer starts its count-down.
2. On timer expiration a temperature and humidity measurement with the highest repeatability is started, the heater remains enabled.
3. After the measurement is finished the heater is turned off.
4. Temperature and humidity values are now available for readout.

The maximum on-time of the heater commands is one second in order to prevent overheating of the sensor by unintended usage of the heater. Thus, there is no dedicated command to turn off the heater. For extended heating periods it is required to send periodic heater-on commands, keeping in mind that the heater is designed for a maximal duty cycle of less than 10%. To obtain a fast increase in temperature the idle time between consecutive heating pulses shall be kept minimal.

Possible Heater Use Cases

There will be dedicated Sensirion application notes elaborating on various use cases of the heater. In general, the applications of the on-package heater range around:

1. Removal of condensed / spray water on the sensor surface. Although condensed water is not a reliability / quality problem to the sensor, it will however make the sensor non-responsive to RH changes in the air as long as there is liquid water on the surface.
2. Creep-free operation in high humid environments. Periodic heating pulses allow for creep-free high-humidity measurements for extended times.

Important notes for operating the heater:

1. The heater is designed for a maximum duty cycle of 10%, meaning the total heater-on-time should not be longer than 10% of the sensor's lifetime.
2. During operation of the heater, sensor specifications are not valid.
3. The temperature sensor can additionally be affected by the thermally induced mechanical stress, offsetting the temperature reading from the actual temperature.
4. The sensor's temperature (base temperature + temperature increase from heater) must not exceed $T_{max} = 125\text{ }^{\circ}\text{C}$ in order to have proper electrical functionality of the chip.
5. The heater draws a large amount of current once enabled (up to $\sim 75\text{ mA}$ in the highest power setting). Although a dedicated circuitry draws this current smoothly, the power supply must be strong enough to avoid large voltage drops that could provoke a sensor reset.
6. If higher heating temperatures are desired, consecutive heating commands must be sent to the sensor. The heater shall only be operated in ambient temperatures below $65\text{ }^{\circ}\text{C}$ or else it could drive the sensor outside of its maximal operating temperature.

5 Physical Specification

5.1 Package Description

SHT4x is provided in an open-cavity dual flat no lead (DFN) package. The humidity sensor opening is centered on the top side of the package. The sensor chip is made of silicon, hosted on a copper lead frame and overmolded by an epoxy-based mold compound. Exposed bottom side of the leadframe with the metallic contacts is Ni/Pd/Au coated, side walls are bare copper.

Moisture sensitivity level (MSL) of one according to IPC/JEDEC J-STD-020 is achieved. It is recommended to process the sensors within one year after date of delivery.

5.2 Package Outline

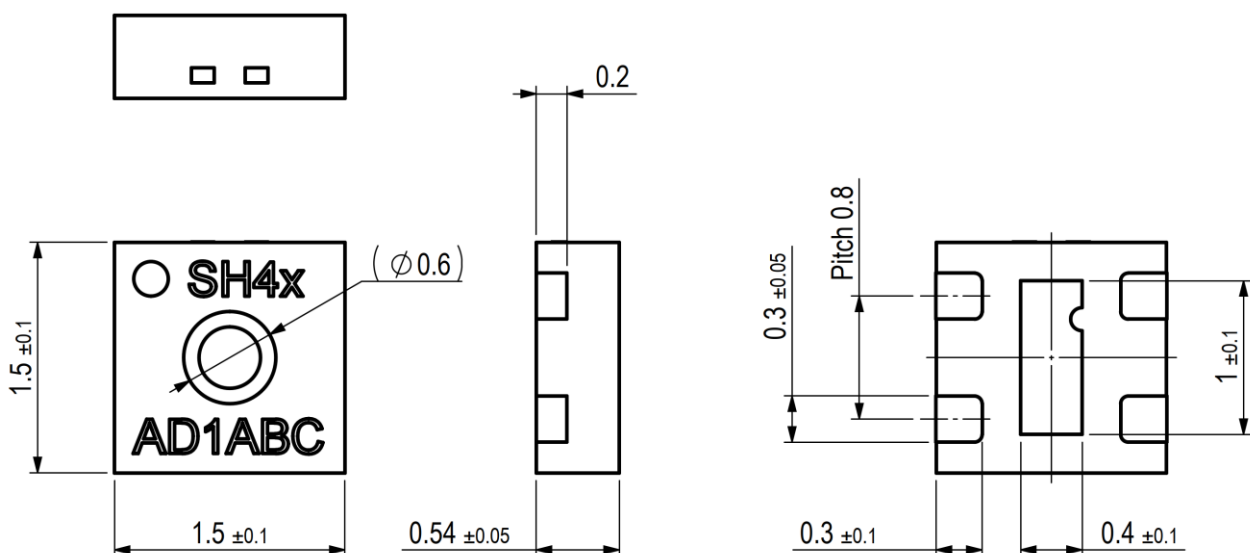

Figure 15. Dimensional drawing of SHT4x including package tolerances (units mm).

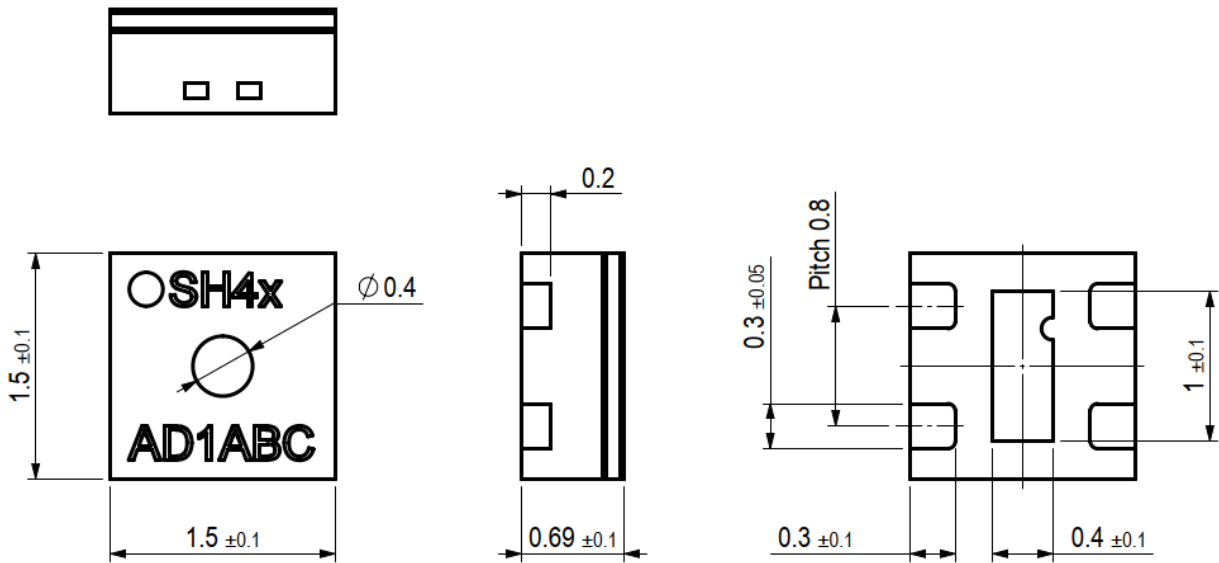

Figure 16. Dimensional drawing of SHT4x with filter membrane including package tolerances (units mm)

5.3 Land Pattern

The land pattern is recommended to be designed according to the used PCB and soldering process together with the physical outer dimensions of the sensor. For reference, the land pattern used with Sensirion's PCBs and soldering processes is given in Figure 17. Soldering of the central die pad is optional. Sensirion recommends not to solder the central die pad because the sensor can reach higher temperatures upon heater activation.

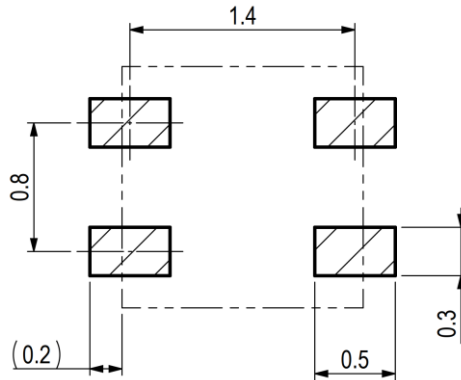

Figure 17. Recommended land pattern (in mm). Details can vary and depend on used PCBs and solder processes. There shall be no copper under the sensor other than at the pin pads.

5.4 Pin Assignment & Laser Marking

Pin	Name	Comments
1	SDA	Serial data, bidirectional
2	SCL	Serial clock, unidirectional input
3	VDD	Supply voltage
4	VSS	Ground

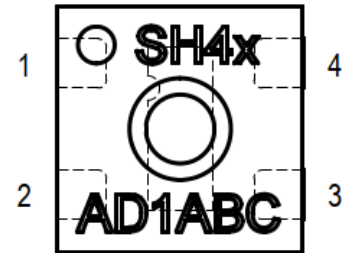

Figure 18. Pin assignment (transparent top view). Dashed lines are only visible if the sensor is viewed from below. The die pad is not directly connected to any pin.

The laser marking consists of two lines, indicated in **Figure 18**. In the first line a filled circle serves as pin-1 indicator and is followed by “SH4”. The last character will indicate the accuracy class of this product (here “x” serves as place holder). In the second line, the first three characters specify the product characteristics according to positions 7, 8 and 9 of **Table 10**. The second three characters serve as internal batch tracking code.¹²

5.5 Thermal Information

Symbol	Description	Heater off, die pad soldered (K/W)	Heater on, die pad soldered (K/W)	Heater off, die pad not soldered (K/W)	Heater on, die pad not soldered (K/W)
$R_{\theta JA}$	Junction-to-ambient thermal resistance	246	308	297	357
$R_{\theta JC}$	Junction-to-case thermal resistance	189	255	191	257
$R_{\theta JB}$	Junction-to-board thermal resistance	159	225	193	258
Ψ_{JB}	Junction-to-board characterization param.	159	223	191	254
Ψ_{JT}	Junction-to-top characterization param.	38	105	44	112

Table 9. Typical values for thermal metrics. In the “heater on” columns a heater power of 200 mW was assumed. Soldering of the die pad is not recommended, therefore the two right hand side columns are bold. Values are based on simulation.

6 Protection Options

6.1 Membrane Option

The filter membrane option for SHT4x family members inherently provides an additional barrier for all pollutants to enter the sensor opening, thus lowering negative influences on the sensing element. Mostly

¹² Please note, there will be no change in the laser marking for the protective option (filter membrane and protective cover).

designed to keep particles and dust from accumulating and reducing the response time, the membrane also enables more efficient and easy cleaning, as it helps to reduce liquid intrusion into the sensor opening. Even though not selectively filtering, in general, physical barriers allow to reduce the amount of unwanted chemical contamination and help to remove potentially harmful components by facilitating wiping (flat sensor surface).

The integrated SHT4x PTFE membrane provides additional protection from particles and enables sensor operation in harsh conditions (according to IP67). The membrane has a thickness of 100 µm offering a filtration efficiency of >99.99% for particles of 200 nm size and larger. Owing to the high permeability and the small volume between sensing element and membrane, the specified response time of the RH sensor is unaltered.



Figure 19. SHT4x with integrated PTFE membrane, highlighting the beneficial flat geometry of the SHT4x

To ensure full functionality of the sensor and avoid damaging its integrated filter membrane, when mounting the sensor, follow the reflow soldering process as described in the Handling Instructions [2]. Furthermore the therein described care regarding board wash and cleaning still apply.

6.2 Protective Cover

The SHT4x will be available with a second protective option, a removable protective cover to protect the sensing element during sensor installation. The sensor will be delivered with the protective cover attached such that the sensor opening is completely covered and sealed. This enables cost-effective brush-over and spray-over application procedures of conformal coating material. Such coating is often required in highly corrosive environments to protect solder joints. In this process the protective cover prevents the sensor opening from being sealed by any coating and to it, the foil can be pulled off with tweezers at the designated non-sticking flap.

The protective cover is made of polyimide making it highly resistant to chemicals and elevated temperatures. To ensure full functionality of the cover, when mounting the sensor, follow the reflow soldering process as described in the Handling Instruction [2].

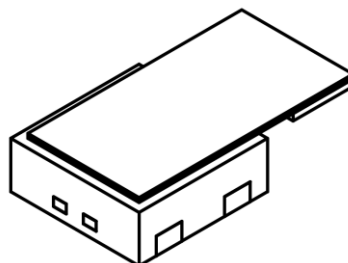

Figure 20. Sketch of the SHT4x with attached polyimide foil.¹³

¹³ This is a preliminary sketch only and might be subject to change.

7 Quality and Material Contents

Qualification of SHT4x is performed based on the JEDEC JESD47 qualification test method, qualification report available on request. The device is fully RoHS and WEEE compliant, e.g. free of Pb, Cd, and Hg. For general remarks of best practice in processing humidity sensor please refer to the handling instructions [2].

8 Tape and Reel Packaging

All specifications for the tape and reel packaging can be found on Figure 21. Reel diameters are 13 inch and 7 inch for the 10k and the 2.5k packaging sizes, respectively.

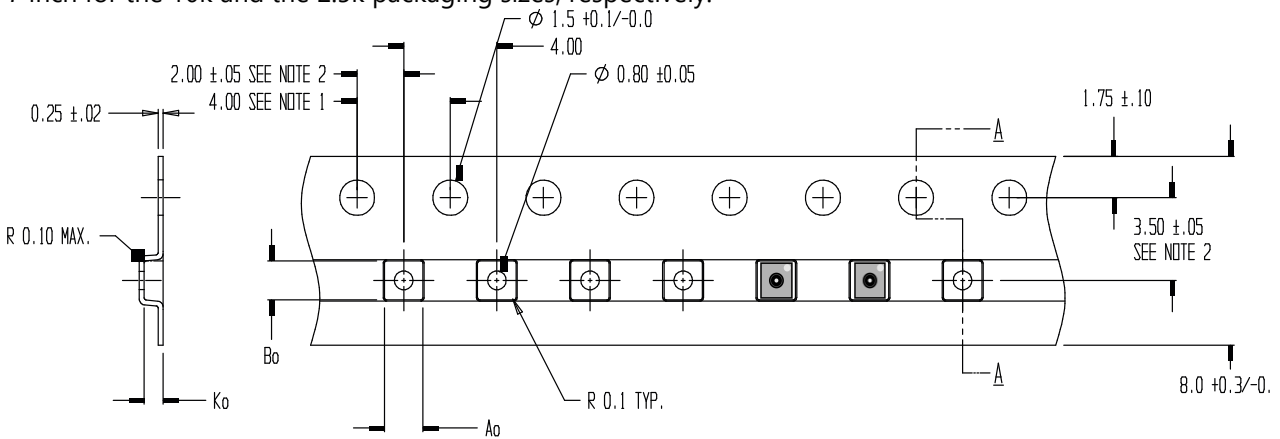

NOTES:

1. 10 SPROCKET HOLE PITCH CUMULATIVE TOLERANCE ± 0.2
2. POCKET POSITION RELATIVE TO SPROCKET HOLE MEASURED AS TRUE POSITION OF POCKET, NOT POCKET HOLE
3. A_0 AND B_0 ARE CALCULATED ON A PLANE AT A DISTANCE "R" ABOVE THE BOTTOM OF THE POCKET.

$A_0 = 1.65 \pm 0.05$
 $B_0 = 1.65 \pm 0.05$
 $K_0 = 0.81 \pm 0.05$

TOLERANCES - UNLESS NOTED 1PL ± 0.2 2PL ± 0.10

Figure 21. Tape and reel specifications including sensor orientation in pocket (see indication of two sensors on the right side of the tape).

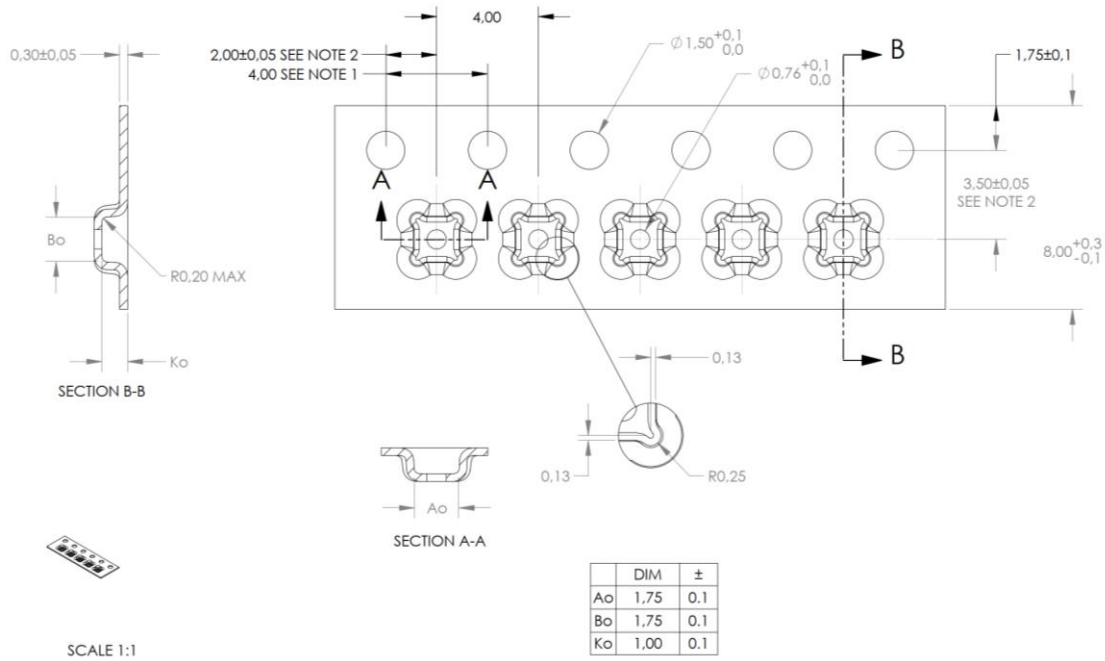

NOTES:

1. 10 SPROCKET HOLE PITCH CUMULATIVE TOLERANCE ±0,2
2. POCKET POSITION RELATIVE TO SPROCKET HOLE MEASURED AS TRUE POSITION OF POCKET, NOT POCKET HOLE.
3. Ao AND Bo ARE MEASURED ON A PLANE AT A DISTANCE "R" ABOVE THE BOTTOM OF THE POCKET.

Figure 22. Tape and reel specification including sensor orientation in pocket of sensor with membrane option.

9 Nomenclature

Position	Value(s)	Explanation
1	S	Sensirion
2	H	Humidity Signal
3	T	Temperature Signal
4	4	Fourth product generation
5	0	Base accuracy
	1	Intermediate accuracy
	5	Best accuracy
	3	ISO17025 certified
6	-	delimiter
7	A	I2C interface with 0x44 address
	B	I2C interface with 0x45 address
	C	I2C interface with 0x46 address
8	D	DFN package
9	1	Reserved
	C	3-point calibrated and certified
10	B	Blank package
	F	Package with integrated, patented PTFE membrane
	P	Package with removable protective cover for conformal coating (coming soon)
11	-	delimiter
12	R	Tape on reel packaging
13	2	Packaging article contains 2'500 pieces
	3	Packaging article contains 10'000 pieces

Table 10. SHT4x product nomenclature. For ordering information, kindly refer to **Table 11**.

10 Ordering Information

Material Description	Material Number	Details	Quantity (pcs)
SHT40-AD1B-R2	3.000.465	base RH&T acc., 0x44 I2C addr.	2'500
SHT40-AD1B-R3	3.000.353	base RH&T acc., 0x44 I2C addr.	10'000
SHT40-AD1F-R2	3.000.820	base RH&T acc., 0x44 I2C addr., including patented PTFE membrane	2'500
SHT40-AD1P-R2	tbd	base RH&T acc., 0x44 I2C addr., including removable protective cover available Q1/24	2'500
SHT40-BD1B-R2	3.000.492	base RH&T acc., 0x45 I2C addr.	2'500
SHT40-BD1F-R2	3.000.887	base RH&T acc., 0x45 I2C addr.	2'500
SHT40-BD1B-R3	3.000.610	base RH&T acc., 0x45 I2C addr.	10'000
SHT40-CD1B-R3	3.000.691	base RH&T acc., 0x46 I2C addr.	10'000
SHT41-AD1B-R2	3.000.466	intermed. RH&T acc., 0x44 I2C addr.	2'500
SHT41-AD1B-R3	3.000.611	intermed. RH&T acc., 0x44 I2C addr.	10'000
SHT41-AD1F-R2	3.000.885	intermed. RH&T acc., 0x44 I2C addr including patented PTFE membrane	2'500
SHT43-ADCB-R2	3.000.682	3-point calibrated, ISO17025 certified, 0x44 I2C addr.	2'500
SHT43-ADCB-R3	3.000.823	3-point calibrated, ISO17025 certified, 0x44 I2C addr.	10'000
SHT43-BDCB-R3	3.000.904	3-point calibrated, ISO17025 certified, 0x45 I2C addr.	10'000
SHT45-AD1B-R2	3.000.645	±1.0 %RH, ±0.1 °C acc., 0x44 I2C addr.	2'500
SHT45-AD1F-R2	3.000.886	±1.0 %RH, ±0.1 °C acc., 0x44 I2C addr. Including patented PTFE membrane	2'500
SHT45-AD1B-R3	3.000.750	±1.0 %RH, ±0.1 °C acc., 0x44 I2C addr.	10'000

Table 11. SHT4x ordering options.

11 Bibliography

- [1] Sensirion, "SHTxx Design Guide," [Online]. Available: www.sensirion.com.
- [2] NXP Semiconductors, "User manual UM10204," vol. Rev. 6, 2014.
- [3] Sensirion, "Handling Instructions for Humidity Sensors," 2020.

12 Revision History

Date	Version	Pages	Changes
October 2020	1	all	Initial release
July 2021	2	multiple 3 4 10 12 21	Typo correction Included checksum in Figure 1 Included description of NIST traceability in section 2 Included repeatability clarification in Table 1 Clarified I2C communication in section 4.1 Removed waiting time specification in Table 5 Specified serial number in section 4.7 Updated qualification status in section 6 Deleted binary com. & included return values in Table 8 Updated note on duty cycle of heater in section 4.9 Added note on large current drawn by heater in section 4.9 Updated ordering information in Table 11
March 2022	3	multiple multiple 4 4 4 10 20 21	Included SHT45 RH- and T-accuracy specifications. Extended max. heater duty cycle to 10% Reduced RH response time to 4s in Table 1 Reduced long-term drift to <0.2%RH/y in Table 1 Reduced hysteresis to 0.8 %RH at 25 °C Table 1 Updated max. measurement times in Table 5 Included I2C communication timing in section 4.2 Introduced new product version in Table 10 Table 10 Updated ordering information in Table 11
November 2022	4	all 4 5 5 6 6 7 15 16 17 19 20 20 21	Updated Datasheet with new SHT43 Edited Table 1 with SHT43 data Inserted Figure 4 Edited Table 2 with SHT43 data Inserted Figure 8 Inserted Figure 12 for SHT43 Inserted section 2.4 Inserted Figure 16 or filter membrane Added footnote 12 for Laser marking of protective options Inserted section 6 about protective options Inserted Figure 20 showing protective cover Inserted Figure 22 Updated Table 10 with SHT43 (3 & C) Updated Table 11 with SHT43-ABDC-R3
January 2023	5	21	Added SHT43-BDCB-R3 to Table 11
February 2023	6	12	Typo correction C= I2C Address 0x46, table formatting
March 2023	6.1	1 12	Added power consumption 0.4 μW in general description Added remark on saving computation resources on page 12
August 2023	6.2	All 6 11 16 18	Reformatting and typo correction Inserting 25°C in Figure 6 - Figure 9 Updated Section 4.2 Inserted comment in Section 6.1 reagrding IP67 Correcting Reel Diameter to 7 inch in section 8

Important Notices

Warning, Personal Injury

Do not use this product as safety or emergency stop devices or in any other application where failure of the product could result in personal injury. Do not use this product for applications other than its intended and authorized use. Before installing, handling, using or servicing this product, please consult the data sheet and application notes. Failure to comply with these instructions could result in death or serious injury.

If the Buyer shall purchase or use SENSIRION products for any unintended or unauthorized application, Buyer shall defend, indemnify and hold harmless SENSIRION and its officers, employees, subsidiaries, affiliates and distributors against all claims, costs, damages and expenses, and reasonable attorney fees arising out of, directly or indirectly, any claim of personal injury or death associated with such unintended or unauthorized use, even if SENSIRION shall be allegedly negligent with respect to the design or the manufacture of the product.

ESD Precautions

The inherent design of this component causes it to be sensitive to electrostatic discharge (ESD). To prevent ESD-induced damage and/or degradation, take customary and statutory ESD precautions when handling this product. See application note "ESD, Latchup and EMC" for more information.

Warranty

SENSIRION warrants solely to the original purchaser of this product for a period of 12 months (one year) from the date of delivery that this product shall be of the quality, material and workmanship defined in SENSIRION's published specifications of the product. Within such period, if proven to be defective, SENSIRION shall repair and/or replace this product, in SENSIRION's discretion, free of charge to the Buyer, provided that:

- notice in writing describing the defects shall be given to SENSIRION within fourteen (14) days after their appearance;
- such defects shall be found, to SENSIRION's reasonable satisfaction, to have arisen from SENSIRION's faulty design, material, or workmanship;
- the defective product shall be returned to SENSIRION's factory at the Buyer's expense; and
- the warranty period for any repaired or replaced product shall be limited to the unexpired portion of the original period.

This warranty does not apply to any equipment which has not been installed and used within the specifications recommended by SENSIRION for the intended and proper use of the equipment. EXCEPT FOR THE WARRANTIES EXPRESSLY SET FORTH HEREIN, SENSIRION MAKES NO WARRANTIES, EITHER EXPRESS OR IMPLIED, WITH RESPECT TO THE PRODUCT. ANY AND ALL WARRANTIES, INCLUDING WITHOUT LIMITATION, WARRANTIES OF MERCHANTABILITY OR FITNESS FOR A PARTICULAR PURPOSE, ARE EXPRESSLY EXCLUDED AND DECLINED.

SENSIRION is only liable for defects of this product arising under the conditions of operation provided for in the data sheet and proper use of the goods. SENSIRION explicitly disclaims all warranties, express or implied, for any period during which the goods are operated or stored not in accordance with the technical specifications.

SENSIRION does not assume any liability arising out of any application or use of any product or circuit and specifically disclaims any and all liability, including without limitation consequential or incidental damages. All operating parameters, including without limitation recommended parameters, must be validated for each customer's applications by customer's technical experts. Recommended parameters can and do vary in different applications.

SENSIRION reserves the right, without further notice, (i) to change the product specifications and/or the information in this document and (ii) to improve reliability, functions and design of this product.

Headquarters and Subsidiaries

Sensirion AG

Laubisruetistr. 50
CH-8712 Staefa ZH
Switzerland

phone: +41 44 306 40 00
fax: +41 44 306 40 30
info@sensirion.com
www.sensirion.com

Sensirion Taiwan Co. Ltd

phone: +886 2 2218-6779
info@sensirion.com
www.sensirion.com

Sensirion Inc., USA

phone: +1 312 690 5858
info-us@sensirion.com
www.sensirion.com

Sensirion Japan Co. Ltd.

phone: +81 45 270 4506
info-jp@sensirion.com
www.sensirion.com/jp

Sensirion Korea Co. Ltd.

phone: +82 31 337 7700~3
info-kr@sensirion.com
www.sensirion.com/kr

Sensirion China Co. Ltd.

phone: +86 755 8252 1501
info-cn@sensirion.com
www.sensirion.com/cn

To find your local representative, please visit
www.sensirion.com/distributors