

Pin layout

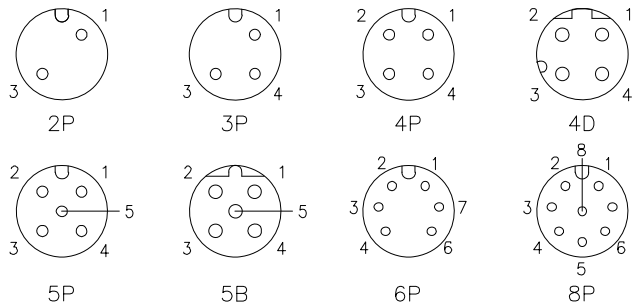

Technical specifications:

Coupling: Threaded coupling
 Termination: screw
 Pollution degree: 3
 Temperature range: -20°C ~ +80°C
 Degree of protection: IP67 when mated
 Mating cycles: ≥500
 Suitable cable Dia: A:4~6mm;B:6~8mm
 Wire gauge: 2~5Pin:AWG22; 6~8Pin:AWG24

Materials:

Contact: Brass
 Contact plating: Gold plated
 Contact insert: TPU Black
 Base shell: Zinc nickel plated
 Hex nut: Brass nickel plated
 Seal: NBR

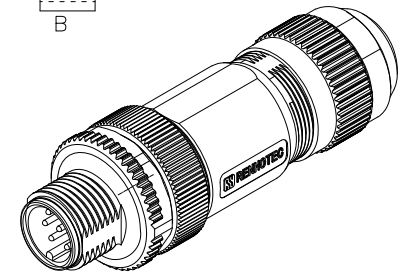
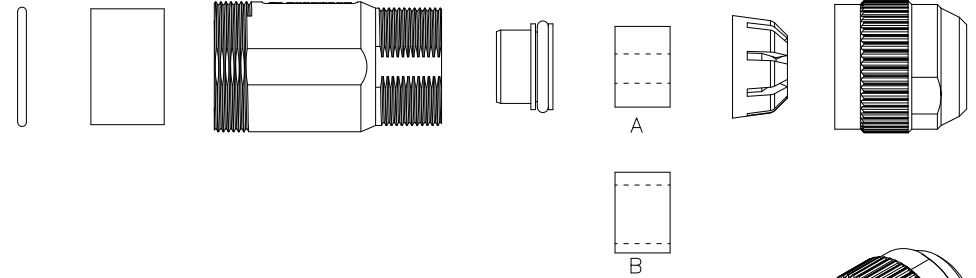
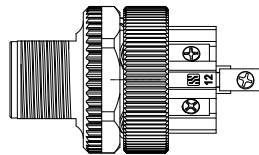
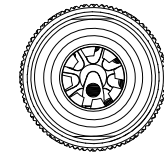
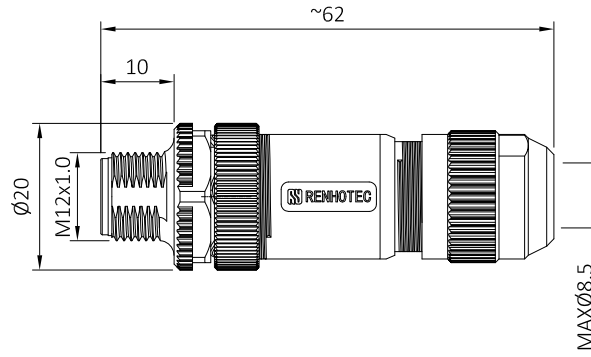
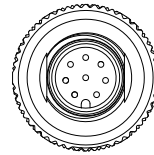

PIN	2	3	4	4D	5	5B	6	8
Rated voltage/ Current	4A/250V	4A/250V	4A/250V	4A/250V	4A/60V	4A/60V	2A/30V	2A/30V
Rated pulse voltage	2500V	2500V	2500V	2500V	1500V	1500V	800V	800V
Insulation resistance (MΩ)	≥ 100	≥ 100	≥ 100	≥ 100	≥ 100	≥ 100	≥ 100	≥ 100
Contact resistance (mΩ)	≤ 5	≤ 5	≤ 5	≤ 5	≤ 5	≤ 5	≤ 5	≤ 5

-TOLERANCES- UNLESS OTHERWISE SPECIFIED	DOSIN INDUSTRIAL(HK)CO.,LTD 江门市德索连接器有限公司 Jiangmen Dosin Connector Co., LTD Web: https://www.dosinconn.cn/ Mailbox: sale@dosin.cn Tel: (0086)769-81153906				
	PART DESCRIPTION: M12 Male connector,Assembly,Shielded				
UNLESS OTHERWISE SPECIFIED TOLERANCES FOR MILLIMETERS ARE: 0.5 - 8mm ± 0.20mm 8 - 30mm ± 0.25mm 30 - 120mm ± 0.30mm	Appr:	JIM.KING			
	Check:	Date	Scale	Unit	Type
	Draw:	2023.08.08	Free	MM	Z
P/N:		DS869MCS0439			
Date		2023.08.08	Scale	Free	Unit
Type		Z	Page		1/1