

SHT4xl - Digital

4th Gen., High-Accuracy, 16-bit, Industrial Grad, Relative Humidity and Temperature Sensor

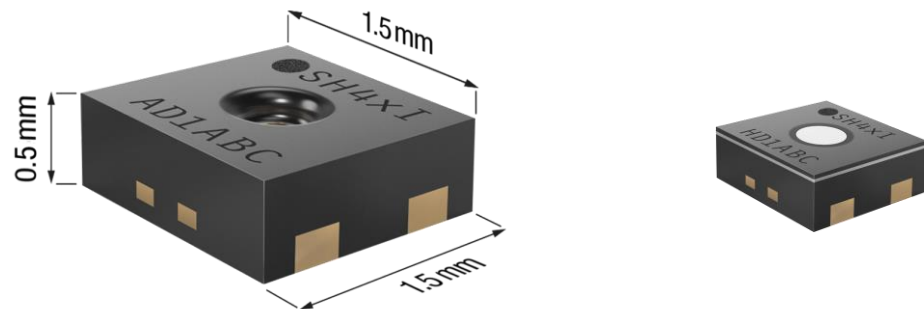

Highlights

- Accuracies $\Delta RH = \pm 2.0\% RH$, $\Delta T = \pm 0.2\text{ }^\circ C$
- Supply voltage $VDD = 2.3\text{ V} \dots 5.5\text{ V}$
- Average current: $21\text{ }\mu A$ (at meas. rate 1 Hz)
- I2C fast mode plus, CRC checksum
- Operating range: $0 \dots 100\% RH$, $-40 \dots 125\text{ }^\circ C$
- Variable power heater
- Fully functional in condensing environment
- Reliable water activity measurement in oil
- NIST traceability
- Mature technology from global market leader
- JEDEC JESD47 qualification, high ESD protec.
- Patented protection options

SHT4xl-Digital is an industrial-grade digital sensor platform for measuring relative humidity and temperature with different accuracy classes. It meets demanding ESD and robustness requirements of industrial applications. The sensors can be interfaced via several preconfigured I2C addresses. An integrated heater allows for advanced on-board-diagnostics while the sensor element is designed for harsh conditions such as condensing environments. The four-pin dual-flat-no-leads package is suitable for surface mount technology (SMT) processing. Protection options such as patented filter membranes and protective covers, available for any member of the SHT4xl-Digital family, enable operation in harshest environments and advanced production processes.

Device Overview

Product	Details
SHT40I-AD1B	base RH&T accur., 0x44 I2C addr.
SHT40I-AD1F	SHT40I-AD1B with PTFE membrane
SHT41I-AD1B	improved RH&T accur., 0x44 I2C addr.
SHT41I-AD1F	SHT41I-AD1B with PTFE membrane

See full product list on page 19.

Functional Block Diagram

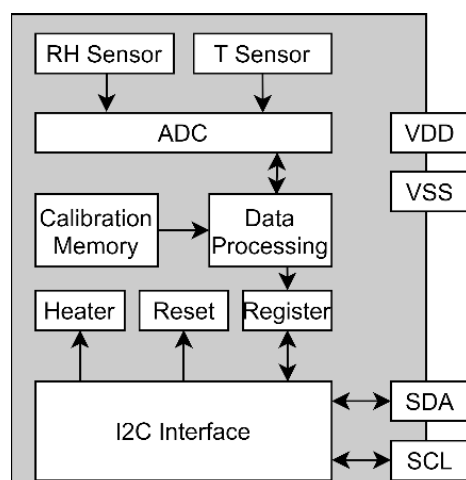

Scan me to provide feedback

Contents

1	Quick Start Guide.....	3
2	Sensor Specifications	4
2.1	Relative Humidity	4
2.2	Temperature.....	5
2.3	Recommended Operating Conditions.....	6
2.4	Water Activity in Oil	6
2.5	Design In.....	7
3	Electrical Specifications	7
3.1	Electrical Characteristics	7
3.2	Timings.....	8
3.3	Absolute Maximum Ratings.....	8
4	Sensor Operation.....	9
4.1	I2C Communication.....	9
4.2	I2C Communication Timing	9
4.3	Data type & length.....	9
4.4	Checksum Calculation	9
4.5	Command Overview.....	10
4.6	Conversion of Signal Output.....	10
4.7	Serial Number.....	11
4.8	Reset & Abort.....	11
4.9	Heater Operation	11
5	Physical Specification	12
5.1	Package Description.....	12
5.2	Package Outline.....	12
5.3	Land Pattern.....	13
5.4	Pin Assignment & Laser Marking	14
5.5	Thermal Information	14
6	Protection Options.....	15
6.1	Membrane Option	15
6.2	Protective Cover	15
7	Quality and Material Contents	16
8	Tape and Reel Packaging	16
9	Nomenclature	18
10	Ordering Information.....	19
11	Bibliography.....	19
12	Revision History.....	20

1 Quick Start Guide

A typical application circuit for SHT4xI-Digital is shown on top of **Figure 1**. After reaching the minimal supply voltage and allowing for the maximal power-up time of 1 ms the sensor is ready for I2C communication. The quickest way to measure humidity and temperature is pseudo-coded on the bottom of **Figure 1**. Together with the conversion formulae given in equations (1), (2), (3) & (4) the digital signals can be translated into relative humidity and temperature readings.

Typical application circuit

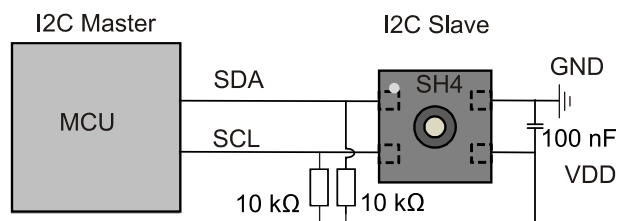

Pseudo code

```

i2c_write(i2c_addr=0x44, tx_bytes=[0xFD])
wait_seconds(0.01)
rx_bytes = i2c_read(i2c_addr=0x44, number_of_bytes=6)
t_ticks = rx_bytes[0] * 256 + rx_bytes[1]
checksum_t = rx_bytes[2]
rh_ticks = rx_bytes[3] * 256 + rx_bytes[4]
checksum_rh = rx_bytes[5]
t_degC = -45 + 175 * t_ticks/65535
rh_pRH = -6 + 125 * rh_ticks/65535
if (rh_pRH > 100):
    rh_pRH = 100
if (rh_pRH < 0):
    rh_pRH = 0
    
```

Figure 1. Typical application circuit (top) and pseudo code (bottom) for easy starting. For details on the signal cropping in the last four lines see section 4.6.

Find code resources and embedded drivers on: <https://github.com/Sensirion/embedded-sht/releases> 

CAD files are available on SnapEDA:

<https://www.snapeda.com/parts/SHT40-AD1B-R3/Sensirion/view-part/> 

2 Sensor Specifications

Every SHT4xl-Digital is individually tested and calibrated and is identifiable by its unique serial number (see section 4.7 for details on the serial number). For the calibration, Sensirion uses transfer standards, which are subject to a scheduled calibration procedure. The calibration of the reference, used for the calibration of the transfer standards, is NIST traceable through an ISO/IEC 17025 accredited laboratory.

2.1 Relative Humidity

Parameter	Conditions	Value	Units
SHT40I-Digital RH accuracy ¹	typ.	±2	%RH
	max.	See Figure 2	-
SHT41I-Digital RH accuracy ¹	typ.	±2	%RH
	max.	See Figure 3	-
Repeatability ^{2, 3}	high	0.08	%RH
	medium	0.15	%RH
	low	0.21	%RH
Resolution ⁴	-	0.01	%RH
Hysteresis	At 25 °C	±0.8	%RH
Specified range ⁵	extended ⁶	0 to 100	%RH
Response time ⁷	$\tau_{63\%}$	4	s
Long-term drift ⁸	typ.	<0.2	%RH/y

Table 1. General relative humidity sensor specifications.

¹ For definition of typ. and max. accuracy, please refer to the document “Sensirion Humidity Sensor Specification Statement”.

² The stated repeatability is three times the standard deviation (3σ) of multiple consecutive measurement values at constant conditions and is a measure for the noise on the physical sensor output. Different repeatability commands are listed in **Table 8**

³ Valid for 25 °C and 50 %RH.

⁴ Resolution of A/D converter.

⁵ Specified range refers to the range for which the humidity or temperature sensor specification is guaranteed.

⁶ For details about recommended humidity and temperature operating range, please refer to section 2.3.

⁷ Time for achieving 63% of a humidity step function, measured at 25 °C and 1 m/s airflow. Humidity response time in the application depends on the design-in of the sensor.

⁸ Typical value for operation in normal RH/T operating range. Value may be higher in environments with vaporized solvents, out-gassing tapes, adhesives, packaging materials, etc. For more details please refer to Handling Instructions. [3]

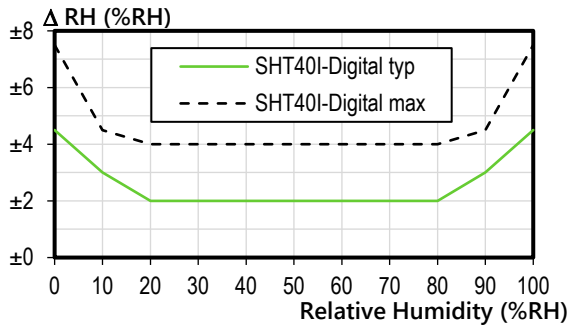

Figure 2. SHT40I-Digital typical and maximal relative humidity accuracy at 25 °C.

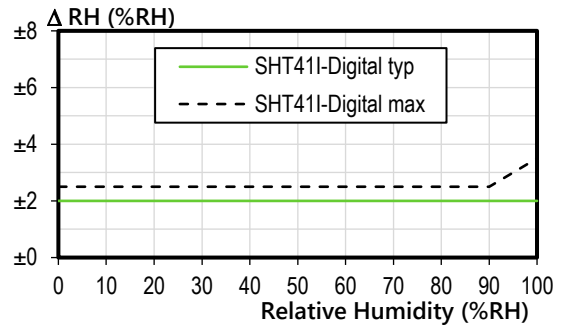

Figure 3. SHT41I-Digital typical and maximal relative humidity accuracy at 25 °C.

2.2 Temperature

Parameter	Conditions	Value	Units
SHT40I-Digital <i>T</i> Accuracy ¹	typ.	±0.2	°C
	max.	see Figure 4	-
SHT41I-Digital <i>T</i> Accuracy ¹	typ.	±0.2	°C
	max.	see Figure 5	-
Repeatability ²	high	0.04	°C
	medium	0.07	°C
	low	0.1	°C
Resolution ⁴	-	0.01	°C
Specified range ⁵	-	-40 to +125	°C
Response time ⁹	$\tau_{63\%}$	2	s
Long-term drift ¹⁰	typ.	<0.03	°C/y

Table 2. General Temperature Sensor specifications.

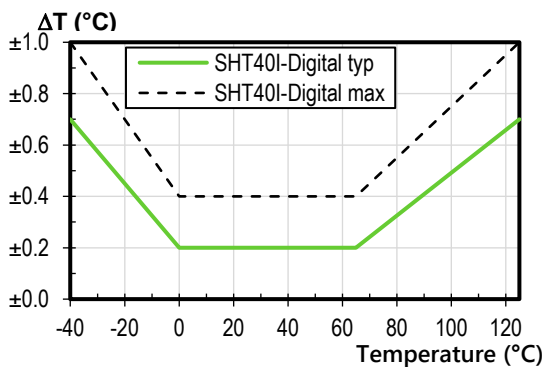

Figure 4. SHT40I-Digital typical and maximal temperature accuracy.

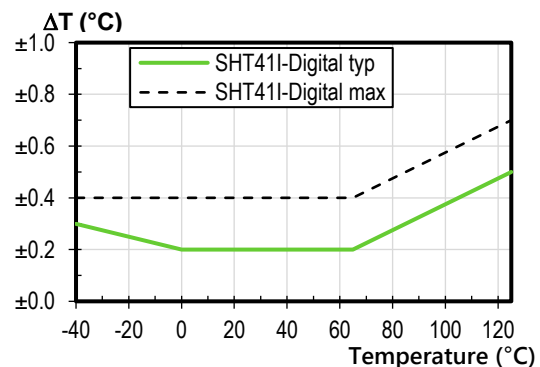

Figure 5. SHT41I-Digital typical and maximal temperature accuracy.

⁹ Temperature response time depends on heat conductivity of sensor substrate and design-in of sensor in application.

¹⁰ Max. value is <0.04 °C/y. And please note that it is different for the SHT43.

2.3 Recommended Operating Conditions

The sensor shows best performance when operated within the recommended normal temperature and humidity range of 5 °C ... 60 °C and 20 %RH ... 80 %RH, respectively. Long term exposure to conditions outside recommended normal range, especially at high relative humidity, may temporarily offset the RH signal (e.g. +3 %RH after 60 h at >80 %RH). After returning into the recommended normal temperature and humidity range the sensor will recover to within specifications by itself. Prolonged exposure to extreme conditions may accelerate aging.

Even though the Sensors from Sensirions SHT4x Family show exceptional resistance to volatile organic compounds and aging, the conditions described in the document "Handling Instructions for humidity Sensors" [2] must be met. Please note as well that this does apply not only to transportation and manufacturing, but also to operation of the SHT4xl-Digital.

2.4 Water Activity in Oil

Increased water activity in an oil indicates advanced aging and quality loss. Being able to retrieve data on the water activity in the oil, allows conclusions to be drawn about the degree of degradation of an oil, which strongly influences its properties, e.g. insulating ability. Thus, in crucial processes relying on the flawless performance of an oil, an implemented online monitoring of an oil's water activity, is very beneficial. For example, the occurrence of breakdowns caused by degraded, no longer insulating oil in electrical transformers, can be predicted, and consequently reduced.

Next to relative humidity measurements in air, the SHT4xl-Digital¹¹ is suitable for water activity measurements in oil¹². Similar to relative humidity, defined as the ratio of partial pressure of water in air and the saturation partial pressure, the water activity (a_w) in oil is defined as the ratio of water in solution to the saturation water content at the corresponding temperature. Conventionally, a_w is indicated in values from 0 to 1 instead of percentages known from relative humidity in air. Therefore, the signal conversion formula for water activity measurements differs from the RH conversion formula, as described in 4.6. Other than that, no additional adaptations compared to the measurement in air are required. Specifications¹³ for the use in mineral transformer oils can be found in **Table 3** below.

Parameter	Conditions	Value	Units
SHT4xl-Digital a_w accuracy	typ.	±0.02	a_w
Resolution ¹⁴	-	0.0001	a_w
Specified a_w range	-	0 to 1	a_w
Long-term drift ¹⁵	max.	0.005	a_w/y

Table 3. Water activity measurement specifications from 15 °C to 60 °C

As differences in oil compositions strongly affect water absorption and diffusion kinetics, and thus the response time during water activity measurements, the response time of the sensor strongly depends on the used oil and cannot be specified generally. Please note, that due to the slow kinetics of water diffusion in oil, placement of the sensor, homogeneity, and potentially mixing conditions, are of utmost importance to obtain correct measurements with any sensor.

¹¹ Excluding version with PTFE membrane

¹² In general a_w is independent of the oil being measured and works regardless of its chemical composition. Nevertheless, careful evaluation of oils is recommended since additives, or some oil components could falsify the measurements or harm the sensor. Furthermore, the sensors should only be used in oils with low electrical conductivity.

¹³ Specified only for temperature range from 15 °C to 60 °C, as determined for J10 transformer oil (DIN 57370 – VDE 0370).

¹⁴ Resolution of A/D converter

¹⁵ Typical value for operation in normal a_w operating range in mineral oils. Value may be higher in environments with higher additive concentration.

2.5 Design In

The above-mentioned specifications hold for the stand-alone sensing element. To achieve the best performance please consult the document Design in Guide [1] on our website Sensirion.com.

3 Electrical Specifications

Valid for all electrical specifications: Typical values correspond to $V_{DD} = 3.3\text{ V}$ and $T = 25\text{ °C}$. Min. and max. values are valid in the full temperature range $-40\text{ °C} \dots 125\text{ °C}$, at declared V_{DD} levels and are based on characterization.

3.1 Electrical Characteristics

Parameter	Symbol	Conditions	Min	Typ.	Max	Units	Comments
Supply voltage	V_{DD}		2.3	3.3	5.5	V	-
Power-up/down level	V_{POR}	Static power supply	0.7	-	2.3	V	-
Supply current (heater off)	I_{DD}	Idle state	-	18	-	μA	-
		Measurement	-	350	-	μA	Average current consumption while sensor is measuring
		Aver., high repeatab. Aver., med repeatab. Aver., low repeatab.	- - -	21 19 18	- - -	μA	Aver. current consumpt. (contin. operation at 1Hz)
Supply current (heater on)	I_{DD}	Nomin. heater "200mW"	-	40	80	mA	see section 4
		Nomin. heater "110mW"	-	22	44	mA	
		Nomin. heater "20mW"	-	4	8	mA	
Low level input voltage	V_{IL}	-	0	-	$0.3^* V_{DD}$	V	-
High level input voltage	V_{IH}	-	$0.7^* V_{DD}$	-	V_{DD}	V	-
Pull up resistors	R_p	$V_{DD} < 3.0\text{ V}$	820	-	-	Ω	-
		$V_{DD} \geq 3.0\text{ V}$	390				
Low level output voltage	V_{OL}	$V_{DD} \geq 2.3\text{ V}, R_p \geq 820\ \Omega$	-	-	0.4	V	-
		$V_{DD} \geq 3.0\text{ V}, R_p \geq 390\ \Omega$					
Cap bus load	C_b	$R_p \geq 820\ \Omega$: fast mode	-	-	400	pF	Capac. bus load can be determined from $C_b < t_{rise} / (0.8473 * R_p)$. Rise times are $t_{rise} = 300\text{ ns}$ for fast mode and $t_{rise} = 120\text{ ns}$ for fast mode plus
		$R_p \geq 390\ \Omega$, $V_{DD} \geq 3.0\text{ V}$: fast mode plus	-	-	340	pF	

Table 4. Electrical specifications.

3.2 Timings

Parameter	Symbol	Conditions	Min.	Typ.	Max.	Units	Comments
Power-up time	t_{PU}	After hard reset, $V_{DD} \geq V_{POR}$	-	0.3	1	ms	Time between V_{DD} reaching V_{POR} and sensor entering idle state
Soft reset time	t_{SR}	After soft reset	-	-	1	ms	Time between ACK of soft reset command and sensor entering idle state. Also valid for I2C general call reset.
Measurement duration	$t_{MEAS,l}$	Low repeatability	-	1.3	1.6	ms	The three repeatability modes differ with respect to measurement duration, noise level and energy consumption
	$t_{MEAS,m}$	Med. repeatability	-	3.7	4.5	ms	
	$t_{MEAS,h}$	High repeatability	-	6.9	8.3	ms	
Heater-on duration	t_{Heater}	Long pulse	0.81	1	1.19	s	After that time the heater is automatically switched off
		Short pulse	0.08	0.1	0.12	s	After that time the heater is automatically switched off

Table 5. System timing specifications

3.3 Absolute Maximum Ratings

Stress levels beyond those listed in **Table 6** may cause permanent damage or affect the reliability of the device. These are stress ratings only and functional operation of the device at these conditions is not guaranteed. Ratings are only tested each at a time.

Parameter	Rating
Supply voltage V_{DD}	-0.3 V...6.0 V
Max. voltage on any pin	VSS -0.3 V ... VDD +0.3 V
Operating temperature range	-40 °C ... 125 °C
Storage temperature range	-40 °C ...150 °C
ESD HBM	4 kV
ESD CDM	750 V
Latch up, JEDEC Class II, 125 °C	±100 mA

Table 6. Absolute maximum ratings.

4 Sensor Operation

4.1 I2C Communication

I2C communication is based on NXP’s I2C-bus specification and user manual UM10204 [3]. Supported I2C modes are standard, fast mode, and fast mode plus. Data is transferred in multiples of 16-bit words. In order to increase reliability of data transfer, I2C glitch protection is offered in form of 8-bit checksum (cyclic redundancy check = CRC, see section 4.4). All transfers must begin with a start condition (S) and terminate with a stop condition (P). To finish a read transfer, send not acknowledge (NACK) and stop condition (P). Addressing a specific slave device is done by sending its 7-bit I2C address followed by an eighth bit, denoting the communication direction: “zero” indicates transmission to the slave, *i.e.* “write”, a “one” indicates a “read” request. Schematics of the I2C transfer types are sketched in **Figure 6**. The sensor does not support clock-stretching. In case the sensor receives a read header and is still busy with *e.g.* measurement or heating, it will return a NACK. Measurement data can only be received once and will be deleted from the sensor’s register after the first acknowledged I2C read header.

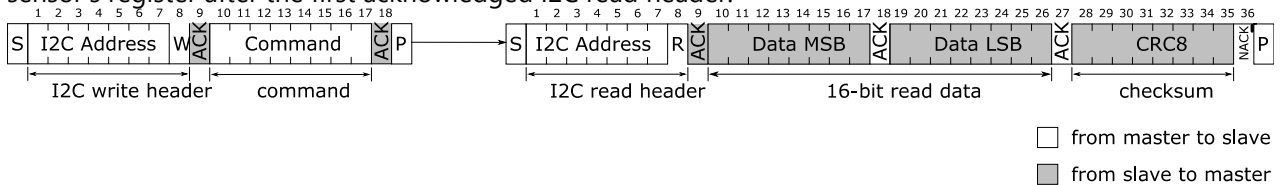

Figure 6. I2C transfer types: First a write header is sent to the I2C slave, followed by a command, for example “measure RH&T with highest precision”. After the measurement is finished the read request directed to this I2C slave will be acknowledged and transmission of data will be started by the slave.

4.2 I2C Communication Timing

All details on the timing are following the interface specification of NXP’s user manual UM10204 [2]. Please follow mandatory capacitor and resistor requirements given in **Table 4**.

4.3 Data type & length

I2C bus operates with 8-bit data packages. Information from the sensor to the master has a checksum after every second 8-bit data package.

Humidity and temperature data will always be transmitted in the following way: The first value is the temperature signal (2 * 8-bit data + 8-bit CRC), the second is the humidity signal (2 * 8-bit data + 8-bit CRC).

4.4 Checksum Calculation

For read transfers each 16-bit data is followed by a checksum with the following properties.

Property	Value
Name	CRC-8
Message Length	16-bit
Polynomial	0x31 ($x^8 + x^5 + x^4 + 1$)
Initialization	0xFF
Reflect Input/Output	false/false
Final XOR	0x00
Examples	CRC(0xBEEF) = 0x92

Table 7. Data checksum properties

The master may abort a read transfer after the 16-bit data if it does not require a checksum.

4.5 Command Overview

Command (hex)	Response length incl. CRC (bytes)	Description [return values]
0xFD	6	measure T & RH with high precision (high repeatability) [2 * 8-bit T-data; 8-bit CRC; 2 * 8-bit RH-data; 8-bit CRC]
0xF6	6	measure T & RH with medium precision (medium repeatability) [2 * 8-bit T-data; 8-bit CRC; 2 * 8-bit RH-data; 8-bit CRC]
0xE0	6	measure T & RH with lowest precision (low repeatability) [2 * 8-bit T-data; 8-bit CRC; 2 * 8-bit RH-data; 8-bit CRC]
0x89	6	read serial number [2 * 8-bit data; 8-bit CRC; 2 * 8-bit data; 8-bit CRC]
0x94	-	soft reset [ACK]
0x39	6	activate heater with 200 mW for 1 s, including a high precision measurement just before deactivation [2 * 8-bit T-data; 8-bit CRC; 2 * 8-bit RH-data; 8-bit CRC]
0x32	6	activate heater with 200 mW for 0.1 s including a high precision measurement just before deactivation [2 * 8-bit T-data; 8-bit CRC; 2 * 8-bit RH-data; 8-bit CRC]
0x2F	6	activate heater with 110 mW for 1 s including a high precision measurement just before deactivation [2 * 8-bit T-data; 8-bit CRC; 2 * 8-bit RH-data; 8-bit CRC]
0x24	6	activate heater with 110 mW for 0.1 s including a high precision measurement just before deactivation [2 * 8-bit T-data; 8-bit CRC; 2 * 8-bit RH-data; 8-bit CRC]
0x1E	6	activate heater with 20 mW for 1 s including a high precision measurement just before deactivation [2 * 8-bit T-data; 8-bit CRC; 2 * 8-bit RH-data; 8-bit CRC]
0x15	6	activate heater with 20 mW for 0.1 s including a high precision measurement just before deactivation [2 * 8-bit T-data; 8-bit CRC; 2 * 8-bit RH-data; 8-bit CRC]

Table 8. Overview of I2C commands. If the sensor is not ready to process a command *e.g.* because it is still measuring, it will response with NACK to the I2C read header. Given heater power values are typical and valid for VDD=3.3 V

4.6 Conversion of Signal Output

The digital sensor signals correspond to following humidity and temperature values:

$$RH = \left(-6 + 125 \cdot \frac{S_{RH}}{2^{16} - 1} \right) \%RH \quad (1)$$

$$a_w = \frac{1}{100} \left(-6 + 125 \cdot \frac{S_{RH}}{2^{16} - 1} \right) \quad (2)$$

$$T = \left(-45 + 175 \cdot \frac{S_T}{2^{16} - 1} \right) ^\circ C \quad (3)$$

$$T = \left(-49 + 315 \cdot \frac{S_T}{2^{16} - 1} \right) ^\circ\text{F} \quad (4)$$

N.B.: The RH conversion formula (1) allows values to be reported which are outside of the range of 0 %RH ... 100 %RH. Relative humidity values which are smaller than 0 %RH and larger than 100 %RH are non-physical; however these “uncropped” values might be found beneficial in some cases (e.g. when the distribution of the sensors at the measurement boundaries are of interest). For all [2]s who do not want to engage in evaluation of these non-physical values, cropping of the RH signal to the range of 0 %RH ... 100 %RH is advised.

N.B. 2: From a computational perspective, in formulae (1),(2), (3) and (4) the division by $2^{16} - 1$ can be simplified to a division by only 2^{16} . The introduced accuracy deviations are <0.002 %RH and <0.003 °C, respectively.

4.7 Serial Number

Each sensor has a unique serial number, that is assigned by Sensirion during production. It is stored in the one-time-programmable memory and cannot be manipulated after production. The serial number is accessible via I2C and is transmitted as two 16-bit words, each followed by an 8-bit CRC.

4.8 Reset & Abort

A reset of the sensor can be achieved in three ways:

1. Soft reset: send the reset command described in **Table 8**
2. I2C general call reset: all devices on I2C bus are reset by sending the command 0x06 to the I2C address 0x00.
3. Power down (incl. pulling SCL and SDA low)

Any command that triggers an action at the sensor can be aborted via I2C general call reset or soft reset.

4.9 Heater Operation

The sensor incorporates an integrated on-package heater which can be switched on by the set of commands given in **Table 8**. Three heating powers and two heating durations are selectable. After reception of a heater-on command, the sensor executes the following procedure:

1. The heater is enabled, and the timer starts its count-down.
2. On timer expiration a temperature and humidity measurement with the highest repeatability is started, the heater remains enabled.
3. After the measurement is finished the heater is turned off.
4. Temperature and humidity values are now available for readout.

The maximum on-time of the heater commands is one second in order to prevent overheating of the sensor by unintended usage of the heater. Thus, there is no dedicated command to turn off the heater. For extended heating periods it is required to send periodic heater-on commands, keeping in mind that the heater is designed for a maximal duty cycle of less than 10%. To obtain a fast increase in temperature the idle time between consecutive heating pulses shall be kept minimal.

Possible Heater Use Cases

There will be dedicated Sensirion application notes elaborating on various use cases of the heater. In general, the applications of the on-package heater range around:

1. Removal of condensed / spray water on the sensor surface. Although condensed water is not a reliability / quality problem to the sensor, it will however make the sensor non-responsive to RH changes in the air as long as there is liquid water on the surface.

2. Creep-free operation in high humid environments. Periodic heating pulses allow for creep-free high-humidity measurements for extended times.

Important notes for operating the heater:

1. The heater is designed for a maximum duty cycle of 10%, meaning the total heater-on-time should not be longer than 10% of the sensor’s lifetime.
2. During operation of the heater, sensor specifications are not valid.
3. The temperature sensor can additionally be affected by the thermally induced mechanical stress, offsetting the temperature reading from the actual temperature.
4. The sensor’s temperature (base temperature + temperature increase from heater) must not exceed $T_{max} = 125\text{ °C}$ in order to have proper electrical functionality of the chip.
5. The heater draws a large amount of current once enabled (up to ~75 mA in the highest power setting). Although a dedicated circuitry draws this current smoothly, the power supply must be strong enough to avoid large voltage drops that could provoke a sensor reset.
6. If higher heating temperatures are desired, consecutive heating commands must be sent to the sensor. The heater shall only be operated in ambient temperatures below 65 °C or else it could drive the sensor outside of its maximal operating temperature.

5 Physical Specification

5.1 Package Description

SHT4xI-Digital is provided in an open-cavity dual flat no lead (DFN) package. The humidity sensor opening is centered on the top side of the package. The sensor chip is made of silicon, hosted on a copper lead frame and overmolded by an epoxy-based mold compound. Exposed bottom side of the leadframe with the metallic contacts is Ni/Pd/Au coated, side walls are bare copper.

Moisture sensitivity level (MSL) of one according to IPC/JEDEC J-STD-020 is achieved. It is recommended to process the sensors within one year after date of delivery.

5.2 Package Outline

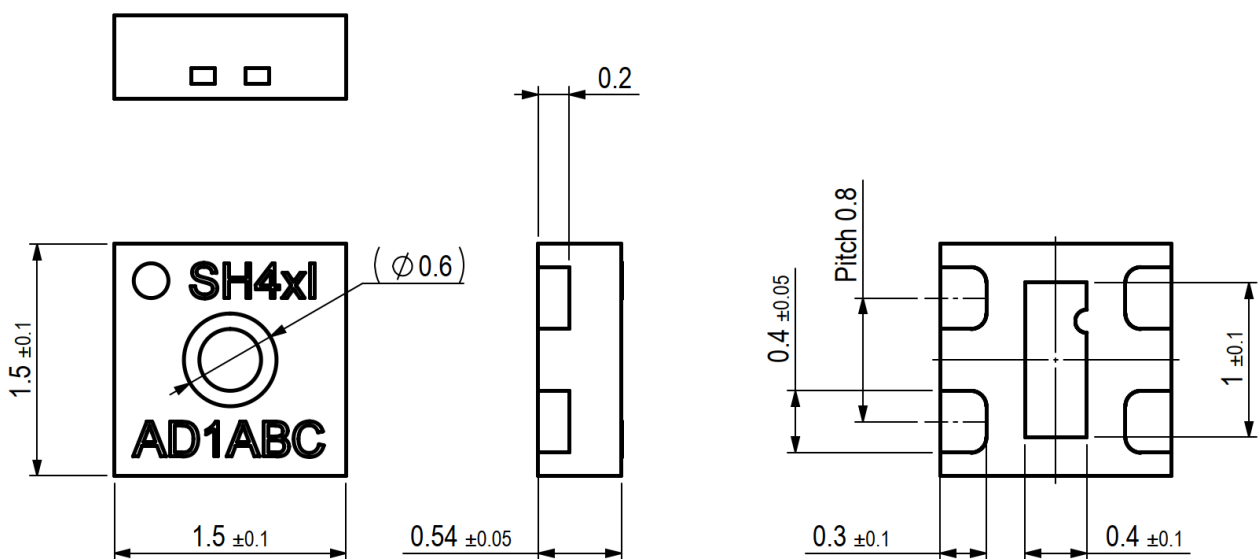

Figure 7. Dimensional drawing of SHT4xI-Digital including package tolerances (units mm).

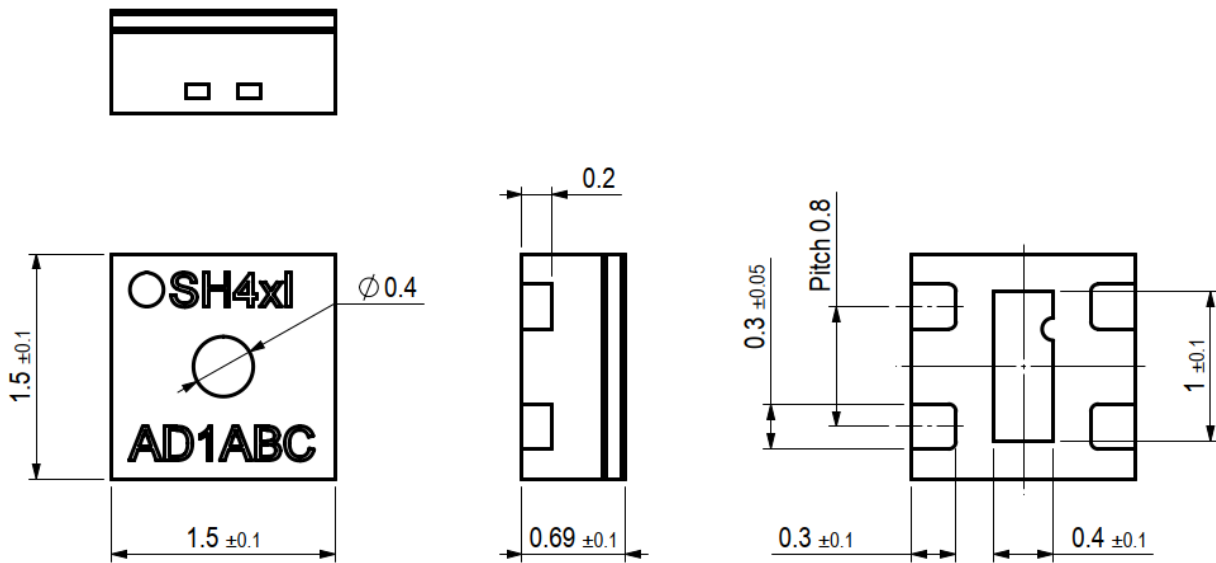

Figure 8. Dimensional drawing of SHT4xl-Digital with filter membrane including package tolerances (units mm)

5.3 Land Pattern

The land pattern is recommended to be designed according to the used PCB and soldering process together with the physical outer dimensions of the sensor. For reference, the land pattern used with Sensirion’s PCBs and soldering processes is given in **Figure 9**. Soldering of the central die pad is optional. Sensirion recommends not to solder the central die pad because the sensor can reach higher temperatures upon heater activation.

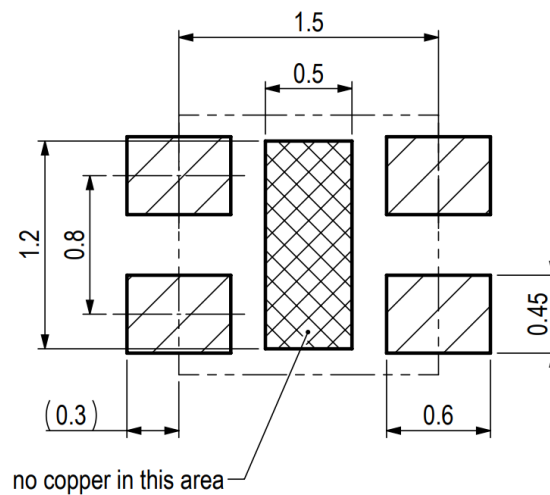

Figure 9. Recommended land pattern (in mm). Details can vary and depend on used PCBs and solder processes. There shall be no copper under the sensor other than at the pin pads.

5.4 Pin Assignment & Laser Marking

Pin	Name	Comments
1	SDA	Serial data, bidirectional
2	SCL	Serial clock, unidirectional input
3	VDD	Supply voltage
4	VSS	Ground

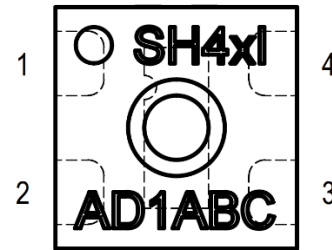

Figure 10. Pin assignment (transparent top view). Dashed lines are only visible if the sensor is viewed from below. The die pad is not directly connected to any pin.

The laser marking consists of two lines, indicated in **Figure 10**. In the first line a filled circle serves as pin-1 indicator and is followed by “SH4”. The fourth character will indicate the accuracy class of this product (here “x” serves as place holder). Last “I” indicates the industrial grade. In the second line, the first three characters specify the product characteristics according to positions 7, 8 and 9 of **Table 10**. The second three characters serve as internal batch tracking code.¹⁶

5.5 Thermal Information

Symbol	Description	Heater off, die pad soldered (K/W)	Heater on, die pad soldered (K/W)	Heater off, die pad not soldered (K/W)	Heater on, die pad not soldered (K/W)
$R_{\theta JA}$	Junction-to-ambient thermal resistance	246	308	297	357
$R_{\theta JC}$	Junction-to-case thermal resistance	189	255	191	257
$R_{\theta JB}$	Junction-to-board thermal resistance	159	225	193	258
Ψ_{JB}	Junction-to-board characterization param.	159	223	191	254
Ψ_{JT}	Junction-to-top characterization param.	38	105	44	112

Table 9. Typical values for thermal metrics. In the “heater on” columns a heater power of 200 mW was assumed. Soldering of the die pad is not recommended, therefore the two right hand side columns are bold. Values are based on simulation.

¹⁶ Please note, there will be no change in the laser marking for the protective option (filter membrane and protective cover).

6 Protection Options

6.1 Membrane Option

The filter membrane option for SHT4xl family members inherently provides an additional barrier for all pollutants to enter the sensor opening, thus lowering negative influences on the sensing element. Mostly designed to keep particles and dust from accumulating and reducing the response time, the membrane also enables more efficient and easy cleaning, as it helps to reduce liquid intrusion into the sensor opening. Even though not selectively filtering, in general, physical barriers allow to reduce the amount of unwanted chemical contamination and help to remove potentially harmful components by facilitating wiping (flat sensor surface). The integrated SHT4xl PTFE membrane provides additional protection from particles and enables sensor operation in harsh conditions (according to IP67). The membrane has a thickness of 100 μm offering a filtration efficiency of >99.99% for particles of 200 nm size and larger. Owing to the high permeability and the small volume between sensing element and membrane, the specified response time of the RH sensor is unaltered.

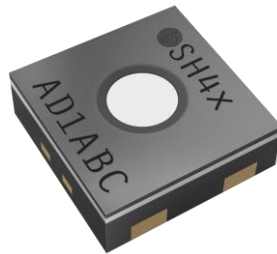

Figure 11. SHT4xl-Digital with integrated PTFE membrane, highlighting the beneficial flat geometry of the SHT4xl-Digital

To ensure full functionality of the sensor and avoid damaging its integrated filter membrane, when mounting the sensor, follow the reflow soldering process as described in the Handling Instructions [2]. Furthermore the therein described care regarding board wash and cleaning still apply.

6.2 Protective Cover

The SHT4xl-Digital will be available with a second protective option, a removable protective cover to protect the sensing element during sensor installation. The sensor will be delivered with the protective cover attached such that the sensor opening is completely covered and sealed. This enables cost-effective brush-over and spray-over application procedures of conformal coating material. Such coating is often required in highly corrosive environments to protect solder joints. In this process the protective cover prevents the sensor opening from being sealed by any coating and to it, the foil can be pulled off with tweezers at the designated non-sticking flap. The protective cover is made of polyimide making it highly resistant to chemicals and elevated temperatures. To ensure full functionality of the cover, when mounting the sensor, follow the reflow soldering process as described in the Handling Instruction [2].

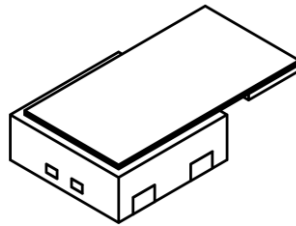

Figure 12. Sketch of the SHT4xI-Digital with attached polyimide foil.¹⁷

7 Quality and Material Contents

Qualification of SHT4xI-Digital is performed based on the JEDEC JESD47 qualification test method, qualification report available on request. The device is fully RoHS and WEEE compliant, e.g. free of Pb, Cd, and Hg.

For general remarks of best practice in processing humidity sensor please refer to the handling instructions [2].

8 Tape and Reel Packaging

All specifications for the tape and reel packaging can be found on Figure 21. Reel diameters are 13 inch and 7 inch for the 10k and the 2.5k packaging sizes, respectively.

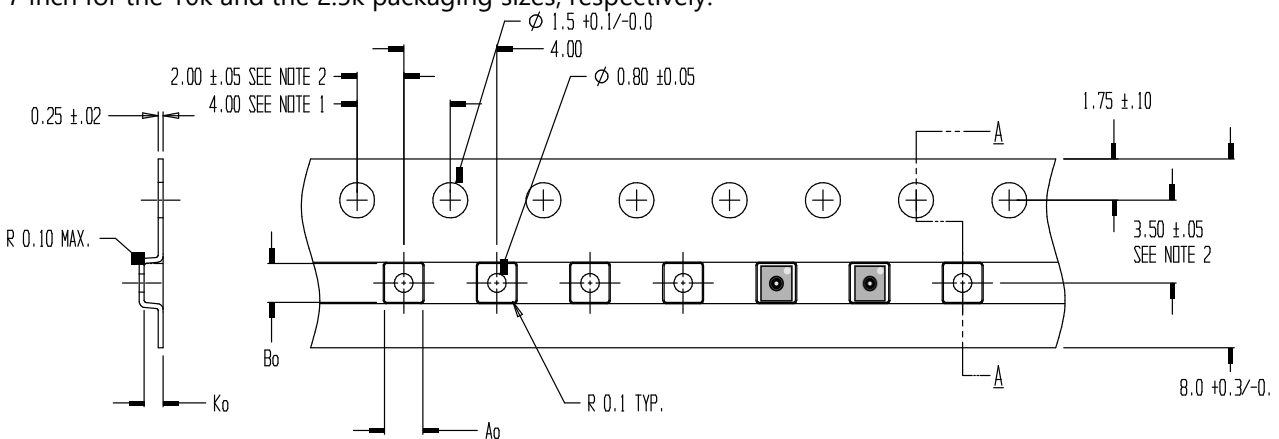

NOTES:

1. 10 SPROCKET HOLE PITCH CUMULATIVE TOLERANCE ± 0.2
2. POCKET POSITION RELATIVE TO SPROCKET HOLE MEASURED AS TRUE POSITION OF POCKET, NOT POCKET HOLE
3. A_0 AND B_0 ARE CALCULATED ON A PLANE AT A DISTANCE "R" ABOVE THE BOTTOM OF THE POCKET.

$A_0 = 1.65 \pm 0.05$
 $B_0 = 1.65 \pm 0.05$
 $K_0 = 0.81 \pm 0.05$

TOLERANCES - UNLESS NOTED 1PL ± 0.2 2PL ± 0.10

Figure 13. Tape and reel specifications including sensor orientation in pocket (see indication of two sensors on the right side of the tape).

¹⁷ This a preliminary sketch only and might be subject to change.

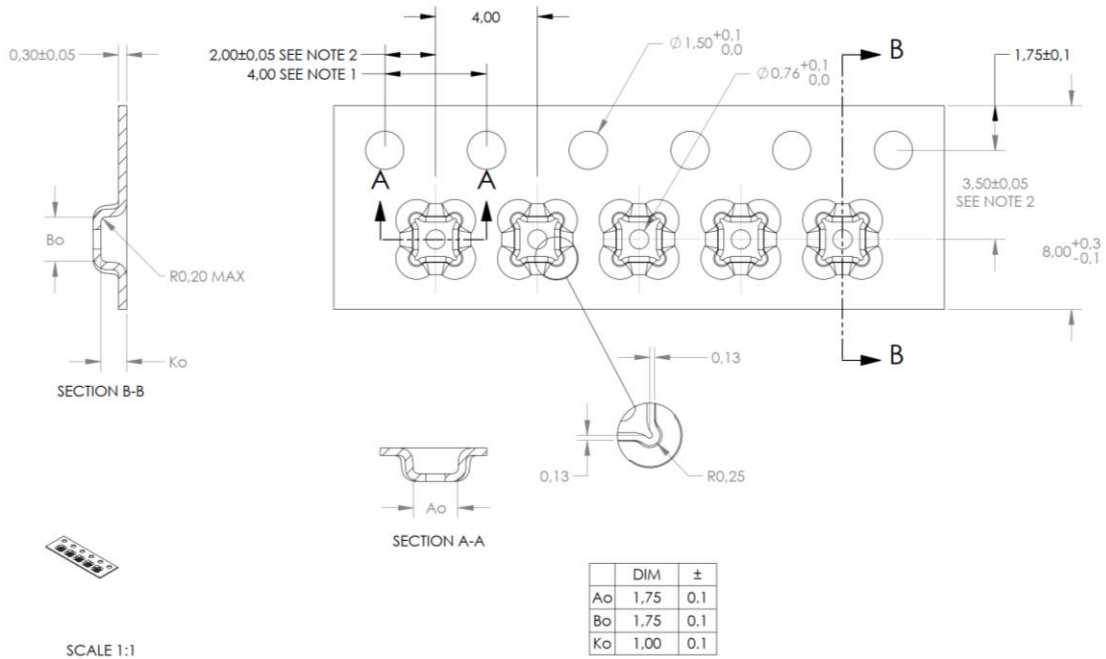

NOTES:

1. 10 SPROCKET HOLE PITCH CUMULATIVE TOLERANCE $\pm 0,2$
2. POCKET POSITION RELATIVE TO SPROCKET HOLE MEASURED AS TRUE POSITION OF POCKET, NOT POCKET HOLE.
3. Ao AND Bo ARE MEASURED ON A PLANE AT A DISTANCE "R" ABOVE THE BOTTOM OF THE POCKET.

Figure 14. Tape and reel specification including sensor orientation in pocket of sensor with membrane option.

9 Product Nomenclature

Position	Value(s)	Explanation
1	S	Sensirion
2	H	Humidity Signal
3	T	Temperature Signal
4	4	Fourth product generation
5	0	Base accuracy
	1	Improved accuracy
7	-	Delimiter
8	A	I2C interface with 0x44 address
	B	I2C interface with 0x45 address
	C	I2C interface with 0x46 address
9	D	DFN package
10	1	Reserved
11	B	Blank package without membrane
	F	Package with integrated, patented PTFE membrane
	P	Package with removable protective cover for conformal coating (coming soon)
12	-	delimiter
13	R	Tape on reel packaging
14	2	Packaging article contains 2'500 pieces
	3	Packaging article contains 10'000 pieces

Table 10. SHT4xI-Digital product nomenclature. For ordering information, kindly refer to **Table 11**.

10 Ordering Information

Material Description	Material Number	Details	Quantity (pcs)
SHT40I-AD1B-R2	3.000.553	base RH&T accuracy, 0x44 I2C addr.	2'500
SHT40I-AD1F-R2	3.000.888	base RH&T accuracy, 0x44 I2C addr. including patented PTFE membrane	2'500
SHT40I-AD1P-R2	tbd	base RH&T accuracy, 0x44 I2C addr. including removable protective cover	2'500
SHT40I-AD1B-R3	3.000.664	base RH&T accuracy, 0x44 I2C addr.	10'000
SHT40I-BD1B-R3	3.000.891	base RH&T accuracy, 0x45 I2C addr.	10'000
SHT40I-CD1B-R3	3.000.890	base RH&T accuracy, 0x46 I2C addr.	10'000
SHT41I-AD1B-R2	3.000.573	improved RH&T accuracy, 0x44 I2C addr.	2'500
SHT41I-AD1F-R2	3.000.885	improved RH&T accuracy, 0x44 I2C addr. including patented PTFE membrane	2'500
SHT41I-AD1P-R2	tbd	improved RH&T accuracy, 0x44 I2C addr. including removable protective cover	2'500
SHT41I-AD1B-R3	3.000.665	improved RH&T accuracy, 0x44 I2C addr.	10'000

Table 11. SHT4xl-Digital ordering options.

11 Bibliography

- [1] Sensirion, "SHTxx Design Guide," [Online]. Available: www.sensirion.com.
- [2] NXP Semiconductors, "User manual UM10204," vol. Rev. 6, 2014.
- [3] Sensirion, "Handling Instructions for Humidity Sensors," 2020.

12 Revision History

Date	Version	Pages	Changes
November 2021	1	All	Initial release
November 2022	2	1 1 3 6 7 10 11 13 14 15 17 18 19 All	Updated Device Overview with membrane options Added Feedback QR Code Added link to snapEDA Added Section 2.4 on water activity measurements Updated Table 4 electrical specs: Supply current "heater on" Corrected erratum in caption of Table 8 old: "... valid for VDD=3.3 V" new: "... valid for VDD=5.0 V" Added water activity sensor signal conversion formula Inserted Figure 8 for filter membrane Footnote 16:no change in laser marking of protective options Added Section 6.2 on protective options Inserted Figure 14 tape/reel specifications of membrane option Updated product nomenclature Table 10 Updated ordering information in Table 11 Reviewed font size, typos, references & general formatting
August 2023	3	All 7 9 10 15 16	Reformatting and typo correction Added Section 2.5 Updated Section 4.1 Adding N.B.2. to Section 4.6 Added "according to Ip67" to section 6.1 Correcting Reel Diameter to 7 inch in section 8

Important Notices

Warning, Personal Injury

Do not use this product as safety or emergency stop devices or in any other application where failure of the product could result in personal injury. Do not use this product for applications other than its intended and authorized use. Before installing, handling, using or servicing this product, please consult the data sheet and application notes. Failure to comply with these instructions could result in death or serious injury.

If the Buyer shall purchase or use SENSIRION products for any unintended or unauthorized application, Buyer shall defend, indemnify and hold harmless SENSIRION and its officers, employees, subsidiaries, affiliates and distributors against all claims, costs, damages and expenses, and reasonable attorney fees arising out of, directly or indirectly, any claim of personal injury or death associated with such unintended or unauthorized use, even if SENSIRION shall be allegedly negligent with respect to the design or the manufacture of the product.

ESD Precautions

The inherent design of this component causes it to be sensitive to electrostatic discharge (ESD). To prevent ESD-induced damage and/or degradation, take customary and statutory ESD precautions when handling this product. See application note "ESD, Latchup and EMC" for more information.

Warranty

SENSIRION warrants solely to the original purchaser of this product for a period of 12 months (one year) from the date of delivery that this product shall be of the quality, material and workmanship defined in SENSIRION's published specifications of the product. Within such period, if proven to be defective, SENSIRION shall repair and/or replace this product, in SENSIRION's discretion, free of charge to the Buyer, provided that:

- notice in writing describing the defects shall be given to SENSIRION within fourteen (14) days after their appearance;
- such defects shall be found, to SENSIRION's reasonable satisfaction, to have arisen from SENSIRION's faulty design, material, or workmanship;
- the defective product shall be returned to SENSIRION's factory at the Buyer's expense; and
- the warranty period for any repaired or replaced product shall be limited to the unexpired portion of the original period.

This warranty does not apply to any equipment which has not been installed and used within the specifications recommended by SENSIRION for the intended and proper use of the equipment. EXCEPT FOR THE WARRANTIES EXPRESSLY SET FORTH HEREIN, SENSIRION MAKES NO WARRANTIES, EITHER EXPRESS OR IMPLIED, WITH RESPECT TO THE PRODUCT. ANY AND ALL WARRANTIES, INCLUDING WITHOUT LIMITATION, WARRANTIES OF MERCHANTABILITY OR FITNESS FOR A PARTICULAR PURPOSE, ARE EXPRESSLY EXCLUDED AND DECLINED.

SENSIRION is only liable for defects of this product arising under the conditions of operation provided for in the data sheet and proper use of the goods. SENSIRION explicitly disclaims all warranties, express or implied, for any period during which the goods are operated or stored not in accordance with the technical specifications.

SENSIRION does not assume any liability arising out of any application or use of any product or circuit and specifically disclaims any and all liability, including without limitation consequential or incidental damages. All operating parameters, including without limitation recommended parameters, must be validated for each customer's applications by customer's technical experts. Recommended parameters can and do vary in different applications.

SENSIRION reserves the right, without further notice, (i) to change the product specifications and/or the information in this document and (ii) to improve reliability, functions and design of this product.

Headquarters and Subsidiaries

Sensirion AG

Laubisruetistr. 50
CH-8712 Staefa ZH
Switzerland

phone: +41 44 306 40 00
fax: +41 44 306 40 30
info@sensirion.com
www.sensirion.com

Sensirion Taiwan Co. Ltd

phone: +886 2 2218-6779
info@sensirion.com
www.sensirion.com

Sensirion Inc., USA

phone: +1 312 690 5858
info-us@sensirion.com
www.sensirion.com

Sensirion Japan Co. Ltd.

phone: +81 45 270 4506
info-jp@sensirion.com
www.sensirion.com/jp

Sensirion Korea Co. Ltd.

phone: +82 31 337 7700~3
info-kr@sensirion.com
www.sensirion.com/kr

Sensirion China Co. Ltd.

phone: +86 755 8252 1501
info-cn@sensirion.com
www.sensirion.com/cn

To find your local representative, please visit
www.sensirion.com/distributors