

1. Designed for long haul 2.5G Single Port Transformer Module
2. Supports four pairs of category 5 UTP cable, Cable interface for isolation and low common mode emissions.
3. Low profile Surface Mount Packaging designed for Hi-Temp Reflow Process
4. Compliant with IEEE 802.3bz standard for 2.5G Base-Z, Designed to support 1:1 Turns Ratio Transceivers.

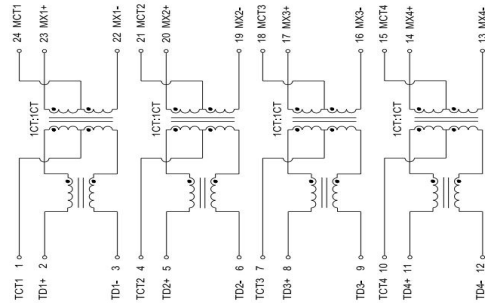

## DIMENSIONS & SCHEMATICS

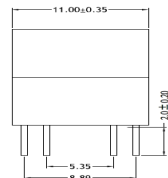
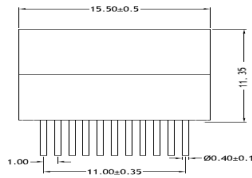
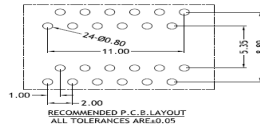
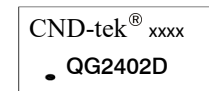

## TECHNICAL SPECIFICATIONS

OCL :	180 $\mu$ H Min. @ 100 KHz, 100mV with 8mA DC Bias
Leakage Inductance:	0.5 $\mu$ H Max. @ 100KHz, 0.1V
Cw/w:	35 pF Max. @ 100KHz, 0.1V
DCR:	1.20 $\Omega$ Max
Turns Ratio( $\pm$ 5%):	1CT:1(TX), 1CT:1(RX)
Polarity:	1-24, 4-21, 8-17, 11-14 In-Phase
Insertion Loss:	-1.0 dB Max. @ 1-100MHz -2.0dB Max. @ 100-200MHz
Return Loss:	-20 dB Min. @ 1-40MHz -20dB + 15*log(f/40)dB Min. @ 41-200MHz
Cross Talk:	-39dB Min. @ 1-100 MHz -25dB Min. @ 100.1-200 MHz
Common Mode Rejection :	-25dB Min. @ 1-200 MHz
Isolation HI-POT:	1500Vrms 1mA 60S or 1650VAC 1mA 6S
Operating Temperature range:	-40 C +85 C
Storage temperature range:	-40 C +125 C

## PACKING SPECIFICATION

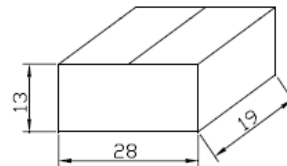
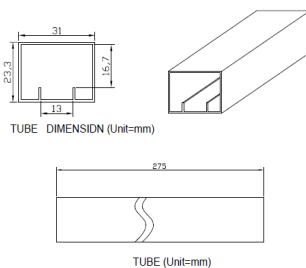

1. units/reel:32PCS
2. reel/carton:10PCS
3. units/carton :3200PCS