

PCB参考图

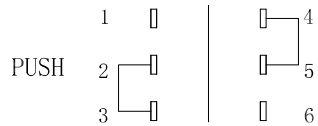

电路简示图

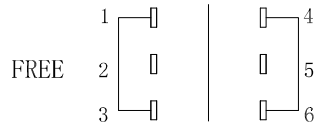
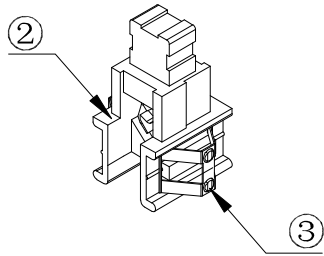
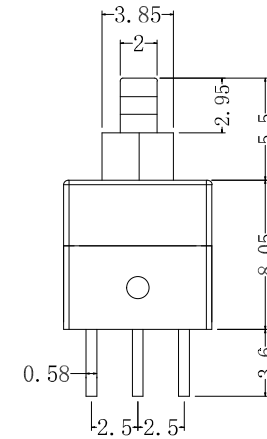
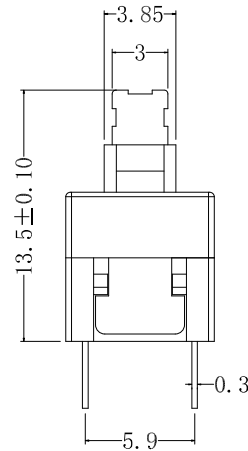
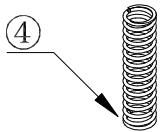

KFC8080-X

OPERATION:W:NO LOCK Z:LOCK

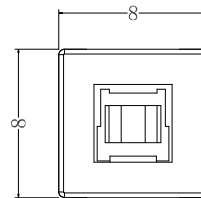

按力: 230 ±30gf

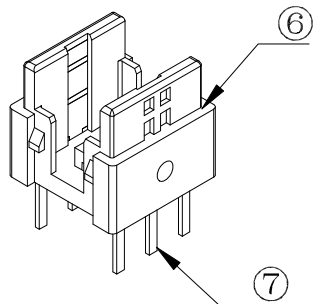
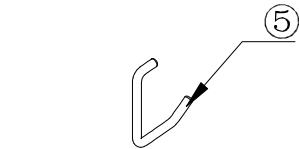

编号	组成部分	数量	材料名称及型号	备注
1	盖子	1	PC	白色
2	按键	1	POM	蓝色
3	簧片	2	磷铜	镀银
4	弹簧	1	碳素钢丝	本色
5	钩针	1	不锈钢丝	本色
6	底座	1	PA66	黑色
7	针脚	6	H65黄铜	镀银

DESIGNED		CHECKED		APPROVAL		DRAWING NUMBER		DATE		REV.		SCALE	
Mikey		Tom		Jerry		KFC8080-X		2015/5/3		A		3:1	
ECN BO.		DESCRIPTION.		APPROVAL		DRAWING NUMBER		DATE.		REV.		SCALE: 1/2	
PART NAME		MODEL NAME		3RD ANGLE PROJ		KFC8080-X		KFC8080-X		UNLESS OTHERWISE SPECIFIED,TOLERANCE:		X. ±0.25 X.x ±0.20 X.xx ±0.15 ANGULAR ±3°	
HanElectricity Co.,LTD		FILE.NO.											

瀚源