

3D View

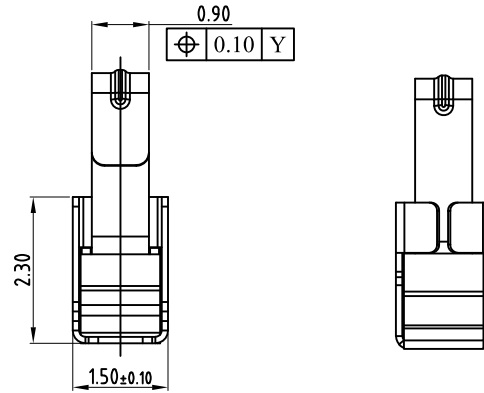

- NOTES:
- MATERIAL
1-1: SUS-304 THICKNE=0.10MM
 - SPECIFICATIONS
2-1: RATED CURRENT: 1.0A
2-2: VOLTAGE RATING: 1.5V
2-3: CONTACT RESISTANCE: 80mΩ/MAX
2-4: WELDING THRUST: ≥3KG
2-5: OPERATING TEMPERATURE: -40°C~+85°C
 - DURABILITY: 1500 CYCLES
 - SALT SPRAY TIME: 24H
 - ELECTROPLATE: THE NICKEL-PLATED SUBSTRATE IS 50u" MIN
 - REQUIREMENTS
6-1: TERMINAL TO EAT FULL TIN, NOT PEELING, WELDING OBVIOUS COLOR AND OTHER ADVERSE
6-2: ROHS, REACH, HF HALOGER ADVERSE OF DOMESTIC AND INTERNATIONAL ENVIRONMENTAL REQUIREMENTS

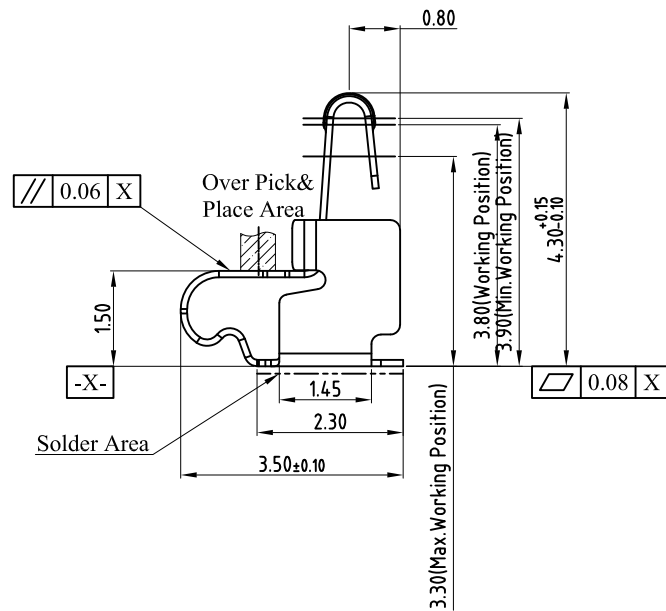
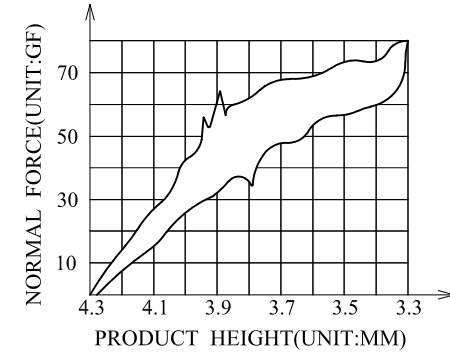
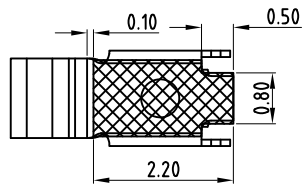

RECOMMENDED PCB LAYOUT
TOLERANCE: ±0.05MM
(FOR REFERENCE ONLY)

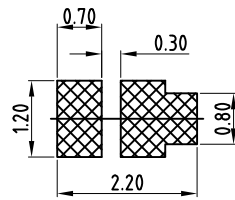

METAL MASK T=0.08
TOLERANCE: ±0.05MM
(FOR REFERENCE ONLY)

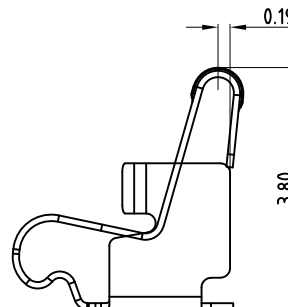

(For Reference Only)
Stated At Compression

 深圳市华宇创精密电子有限公司			
TOLERANCE: X.X ±0.30 X.XX ±0.25 X.XXX ±0.15 X' ±2' X.X' ±0.5'	DRAWN BY : 陈一鸣	DATE : 2014-02-23	PART NAME: 天线弹片 L3.50*W1.5*H4.3
	CHECKED BY: 马跃	DATE : 2014-02-23	PART NO. HYCW-TXT351543A
UNIT: mm [inch]	APPROVED BY: 邱敏	DATE : 2014-02-23	DRAW NO: HYC-2406081802
SCALE: 1:1	SIZE: A4		SHEET NO. 1 OF 1