

### Description

The TSZ121/122 of high precision operational amplifiers offer very low input offset voltages with virtually zero drift. TSZ121 is the single version, TSZ122 the dual version, with pinouts compatible with industry standards. The TSZ121/122 offers rail-to-rail input and output, excellent speed/ power consumption ratio, and 400 kHz gain bandwidth product, while consuming less than 40  $\mu$ A at 5 V. The devices also feature an ultra-low input bias current. These features make the TSZ121/122 family ideal for sensor interfaces, battery-powered applications and portable applications.

### Applications

- Battery-powered applications
- Portable devices
- Signal conditioning
- Medical instrumentation

### Features

- Very high accuracy and stability: offset voltage 5  $\mu$ V max at 25  $^{\circ}$ C, 8  $\mu$ V over full temperature range (-40  $^{\circ}$ C to 125  $^{\circ}$ C)
- Rail-to-rail input and output
- Low supply voltage: 1.8 - 5.5 V
- Low power consumption: 40  $\mu$ A max. at 5 V
- Gain bandwidth product: 400 kHz
- High tolerance to ESD: 4 kV HBM
- Extended temperature range: -40 to 125  $^{\circ}$ C

### Package pin connections

Figure 1. Pin connections for each package (top view)

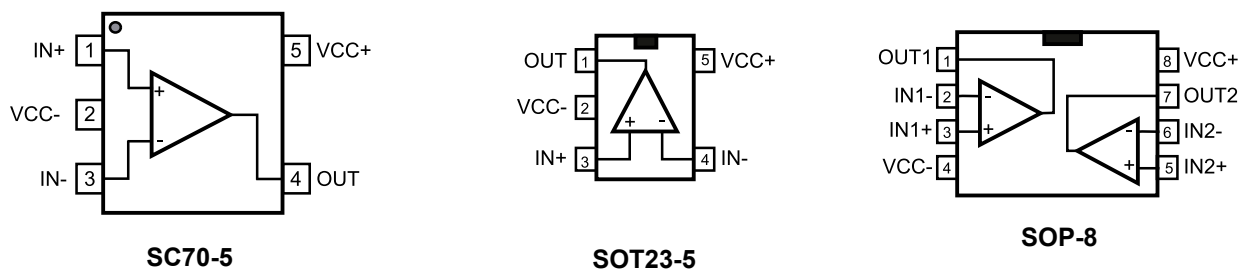

**Absolute maximum ratings and operating conditions**
**Table 1. Absolute maximum ratings (AMR)**

Symbol	Parameter		Value	Unit
$V_{CC}$	Supply voltage <sup>(1)</sup>		6	
$V_{id}$	Differential input voltage <sup>(2)</sup>		$\pm V_{CC}$	V
$V_{in}$	Input voltage <sup>(3)</sup>		$(V_{CC-}) - 0.2$ to $(V_{CC+}) + 0.2$	
$I_{in}$	Input current <sup>(4)</sup>		10	mA
$T_{stg}$	Storage temperature		-65 to 150	°C
$T_j$	Maximum junction temperature		150	
$R_{thja}$	Thermal resistance junction to ambient <sup>(5) (6)</sup>	SC70-5	205	°C/W
		SOT23-5	250	
		SOP-8	125	
ESD	HBM: human body model <sup>(7)</sup>		4	kV
	MM: machine model <sup>(8)</sup>		300	V
	CDM: charged device model <sup>(9)</sup>		1.5	kV
	Latch-up immunity		200	mA

- All voltage values, except the differential voltage are with respect to the network ground terminal.
- The differential voltage is the non-inverting input terminal with respect to the inverting input terminal.
- $V_{CC} - V_{in}$  must not exceed 6 V,  $V_{in}$  must not exceed 6 V
- Input current must be limited by a resistor in series with the inputs.
- $R_{th}$  are typical values.
- Short-circuits can cause excessive heating and destructive dissipation.
- Human body model: 100 pF discharged through a 1.5 k $\Omega$  resistor between two pins of the device, done for all couples of pin combinations with other pins floating.
- Machine model: a 200 pF cap is charged to the specified voltage, then discharged directly between two pins of the device with no external series resistor (internal resistor < 5  $\Omega$ ), done for all couples of pin combinations with other pins floating.
- Charged device model: all pins plus package are charged together to the specified voltage and then discharged directly to ground.

**Table 2. Operating conditions**

Symbol	Parameter	Value	Unit
$V_{CC}$	Supply voltage	1.8 to 5.5	V
$V_{icm}$	Common mode input voltage range	$(V_{CC-}) - 0.1$ to $(V_{CC+}) + 0.1$	
$T_{oper}$	Operating free air temperature range	-40 to 125	°C

**Very high accuracy (5  $\mu$ V) zero drift micropower 5 V operational amplifiers**
**Electrical characteristics**
**Table 3. Electrical characteristics at  $V_{CC+} = 1.8$  V with  $V_{CC-} = 0$  V,  $V_{icm} = V_{CC}/2$ ,  $T = 25$  °C, and  $R_L = 10$  k $\Omega$  connected to  $V_{CC}/2$  (unless otherwise specified)**

Symbol	Parameter	Conditions	Min.	Typ.	Max.	Unit
$V_{io}$	Input offset voltage	$T = 25$ °C		1	5	$\mu$ V
		$-40$ °C < $T < 125$ °C			8	
$\Delta V_{io}/\Delta T$	Input offset voltage drift <sup>(1)</sup>	$-40$ °C < $T < 125$ °C		10	30	nV/°C
$I_{ib}$	Input bias current ( $V_{out} = V_{CC}/2$ )	$T = 25$ °C		50	200 <sup>(2)</sup>	$\mu$ A
		$-40$ °C < $T < 125$ °C			300 <sup>(2)</sup>	
$I_{io}$	Input offset current ( $V_{out} = V_{CC}/2$ )	$T = 25$ °C		100	400 <sup>(2)</sup>	
		$-40$ °C < $T < 125$ °C			600 <sup>(2)</sup>	
CMR	Common mode rejection ratio, 20 log ( $\Delta V_{icm}/\Delta V_{io}$ ), $V_{ic} = 0$ V to $V_{CC}$ , $V_{out} = V_{CC}/2$ , $R_L > 1$ M $\Omega$	$T = 25$ °C	110	122		dB
		$-40$ °C < $T < 125$ °C	110			
$A_{vd}$	Large signal voltage gain, $V_{out} = 0.5$ V to ( $V_{CC} - 0.5$ V)	$T = 25$ °C	118	135		
		$-40$ °C < $T < 125$ °C	110			
$V_{OH}$	High-level output voltage	$T = 25$ °C			30	mV
$V_{OL}$	Low-level output voltage	$-40$ °C < $T < 125$ °C			70	
		$T = 25$ °C			30	
		$-40$ °C < $T < 125$ °C			70	
$I_{out}$	$I_{sink}$ ( $V_{out} = V_{CC}$ )	$T = 25$ °C	7	8		mA
		$-40$ °C < $T < 125$ °C	6			
	$I_{source}$ ( $V_{out} = 0$ V)	$T = 25$ °C	5	7		
		$-40$ °C < $T < 125$ °C	4			
$I_{CC}$	Supply current (per amplifier, $V_{out} = V_{CC}/2$ , $R_L > 1$ M $\Omega$ )	$T = 25$ °C		28	40	$\mu$ A
		$-40$ °C < $T < 125$ °C			40	
GBP	Gain bandwidth product	$R_L = 10$ k $\Omega$ , $C_L = 100$ pF		400		kHz
$F_u$	Unity gain frequency			300		
$\phi_m$	Phase margin			55		Degrees
$G_m$	Gain margin			17		dB
SR	Slew rate <sup>(3)</sup>			0.17		V/ $\mu$ s
$t_s$	Setting time		To 0.1 %, $V_{in} = 1$ Vp-p, $R_L = 10$ k $\Omega$ , $C_L = 100$ pF		50	
$e_n$	Equivalent input noise voltage	$f = 1$ kHz		60		nV/ $\sqrt$ Hz
		$f = 10$ kHz		60		
$\int e_n$	Low-frequency peak-to-peak input noise	Bandwidth, $f = 0.1$ to 10 Hz		1.1		$\mu$ Vpp
$C_s$	Channel separation	$f = 100$ Hz		120		dB
$t_{init}$	Initialization time	$T = 25$ °C		50		$\mu$ s
		$-40$ °C < $T < 125$ °C		100		

**Very high accuracy (5  $\mu$ V) zero drift micropower 5 V operational amplifiers**
**Table 4. Electrical characteristics at  $V_{CC+} = 3.3$  V with  $V_{CC-} = 0$  V,  $V_{icm} = V_{CC}/2$ ,  $T = 25$  °C, and  $R_L = 10$  k $\Omega$  connected to  $V_{CC}/2$  (unless otherwise specified)**

Symbol	Parameter	Conditions	Min.	Typ.	Max.	Unit
$V_{io}$	Input offset voltage	$T = 25$ °C		1	5	$\mu$ V
		$-40$ °C < $T < 125$ °C			8	
$\Delta V_{io}/\Delta T$	Input offset voltage drift <sup>(1)</sup>	$-40$ °C < $T < 125$ °C		10	30	nV/°C
$I_{ib}$	Input bias current ( $V_{out} = V_{CC}/2$ )	$T = 25$ °C		60	200 <sup>(2)</sup>	pA
		$-40$ °C < $T < 125$ °C			300 <sup>(2)</sup>	
$I_{io}$	Input offset current ( $V_{out} = V_{CC}/2$ )	$T = 25$ °C		120	400 <sup>(2)</sup>	
		$-40$ °C < $T < 125$ °C			600 <sup>(2)</sup>	
CMR	Common mode rejection ratio, 20 log ( $\Delta V_{icm}/\Delta V_{io}$ ), $V_{ic} = 0$ V to $V_{CC}$ , $V_{out} = V_{CC}/2$ , $R_L > 1$ M $\Omega$	$T = 25$ °C	115	128		dB
		$-40$ °C < $T < 125$ °C	115			
$A_{vd}$	Large signal voltage gain, $V_{out} = 0.5$ V to ( $V_{CC} - 0.5$ V)	$T = 25$ °C	118	135		
		$-40$ °C < $T < 125$ °C	110			
$V_{OH}$	High-level output voltage	$T = 25$ °C			30	mV
		$-40$ °C < $T < 125$ °C			70	
$V_{OL}$	Low-level output voltage	$T = 25$ °C			30	
		$-40$ °C < $T < 125$ °C			70	
$I_{out}$	$I_{sink}$ ( $V_{out} = V_{CC}$ )	$T = 25$ °C	15	18		mA
		$-40$ °C < $T < 125$ °C	12			
	$I_{source}$ ( $V_{out} = 0$ V)	$T = 25$ °C	14	16		
		$-40$ °C < $T < 125$ °C	10			
$I_{CC}$	Supply current (per amplifier, $V_{out} = V_{CC}/2$ , $R_L > 1$ M $\Omega$ )	$T = 25$ °C		29	40	$\mu$ A
		$-40$ °C < $T < 125$ °C			40	
GBP	Gain bandwidth product			400		kHz
$F_u$	Unity gain frequency			300		
$\phi_m$	Phase margin	$R_L = 10$ k $\Omega$ , $C_L = 100$ pF		56		Degrees
$G_m$	Gain margin			19		dB
SR	Slew rate <sup>(3)</sup>			0.19		V/ $\mu$ s
$t_s$	Setting time		To 0.1 %, $V_{in} = 1$ Vp-p, $R_L = 10$ k $\Omega$ , $C_L = 100$ pF		50	
$e_n$	Equivalent input noise voltage	$f = 1$ kHz		40		nV/ $\sqrt$ Hz
		$f = 10$ kHz		40		
$f_{e_n}$	Low-frequency peak-to-peak input noise	Bandwidth, $f = 0.1$ to 10 Hz		0.8		$\mu$ Vpp
$C_s$	Channel separation	$f = 100$ Hz		120		dB
$t_{init}$	Initialization time	$T = 25$ °C		50		$\mu$ s
		$-40$ °C < $T < 125$ °C		100		

**Very high accuracy (5  $\mu$ V) zero drift micropower 5 V operational amplifiers**
**Table 5. Electrical characteristics at  $V_{CC+} = 5$  V with  $V_{CC-} = 0$  V,  $V_{icm} = V_{CC}/2$ ,  $T = 25$  °C, and  $R_L = 10$  k $\Omega$  connected to  $V_{CC}/2$  (unless otherwise specified)**

Symbol	Parameter	Conditions	Min.	Typ.	Max.	Unit
$V_{io}$	Input offset voltage	$T = 25$ °C		1	5	$\mu$ V
		$-40$ °C < $T$ < $125$ °C			8	
$\Delta V_{io}/\Delta T$	Input offset voltage drift <sup>(1)</sup>	$-40$ °C < $T$ < $125$ °C		10	30	nV/°C
$I_{ib}$	Input bias current ( $V_{out} = V_{CC}/2$ )	$T = 25$ °C		70	200 <sup>(2)</sup>	pA
		$-40$ °C < $T$ < $125$ °C			300 <sup>(2)</sup>	
$I_{io}$	Input offset current ( $V_{out} = V_{CC}/2$ )	$T = 25$ °C		140	400 <sup>(2)</sup>	pA
		$-40$ °C < $T$ < $125$ °C			600 <sup>(2)</sup>	
CMR	Common mode rejection ratio, 20 log ( $\Delta V_{icm}/\Delta V_{io}$ ), $V_{ic} = 0$ V to $V_{CC}$ , $V_{out} = V_{CC}/2$ , $R_L > 1$ M $\Omega$	$T = 25$ °C	115	136		dB
		$-40$ °C < $T$ < $125$ °C	115			
SVR	Supply voltage rejection ratio, 20 log ( $\Delta V_{CC}/\Delta V_{io}$ ), $V_{CC} = 1.8$ V to 5.5 V, $V_{out} = V_{CC}/2$ , $R_L > 1$ M $\Omega$	$T = 25$ °C	120	140		dB
		$-40$ °C < $T$ < $125$ °C	120			
$A_{vd}$	Large signal voltage gain, $V_{out} = 0.5$ V to ( $V_{CC} - 0.5$ V)	$T = 25$ °C	120	135		dB
		$-40$ °C < $T$ < $125$ °C	110			
		$V_{RF} = 100$ mV <sub>p</sub> , $f = 400$ MHz		84		
EMIRR <sup>(3)</sup>	EMI rejection rate = $-20$ log ( $V_{RFpeak}/\Delta V_{io}$ )	$V_{RF} = 100$ mV <sub>p</sub> , $f = 900$ MHz		87		dB
		$V_{RF} = 100$ mV <sub>p</sub> , $f = 1800$ MHz		90		
		$V_{RF} = 100$ mV <sub>p</sub> , $f = 2400$ MHz		91		
$V_{OH}$	High-level output voltage	$T = 25$ °C			30	mV
		$-40$ °C < $T$ < $125$ °C			70	
$V_{OL}$	Low-level output voltage	$T = 25$ °C			30	mV
		$-40$ °C < $T$ < $125$ °C			70	
$I_{out}$	$I_{sink}$ ( $V_{out} = V_{CC}$ )	$T = 25$ °C	15	18		mA
		$-40$ °C < $T$ < $125$ °C	14			
	$I_{source}$ ( $V_{out} = 0$ V)	$T = 25$ °C	14	17		
		$-40$ °C < $T$ < $125$ °C	12			
$I_{CC}$	Supply current (per amplifier, $V_{out} = V_{CC}/2$ , $R_L > 1$ M $\Omega$ )	$T = 25$ °C		31	40	$\mu$ A
		$-40$ °C < $T$ < $125$ °C			40	
GBP	Gain bandwidth product	$R_L = 10$ k $\Omega$ , $C_L = 100$ pF		400		kHz
$F_u$	Unity gain frequency			300		

Very high accuracy (5  $\mu$ V) zero drift micropower 5 V operational amplifiers

Symbol	Parameter	Conditions	Min.	Typ.	Max.	Unit
$\phi_m$	Phase margin			53		Degrees
$G_m$	Gain margin	$R_L = 10\text{ k}\Omega, C_L = 100\text{ pF}$		19		dB
SR	Slew rate <sup>(4)</sup>			0.19		V/ $\mu$ s
$t_s$	Setting time	To 0.1 %, $V_{in} = 100\text{ mVp-p}, R_L = 10\text{ k}\Omega, C_L = 100\text{ pF}$		10		$\mu$ s
$e_n$	Equivalent input noise voltage	f = 1 kHz		37		nV/ $\sqrt{\text{Hz}}$
		f = 10 kHz		37		
$f_{e_n}$	Low-frequency peak-to-peak input noise	Bandwidth, f = 0.1 to 10 Hz		0.75		$\mu$ Vpp
$C_s$	Channel separation	f = 100 Hz		120		dB
$t_{init}$	Initialization time	T = 25 °C		50		$\mu$ s
		-40 °C < T < 125 °C		100		

### Electrical characteristic curves

Figure 2. Supply current vs. supply voltage

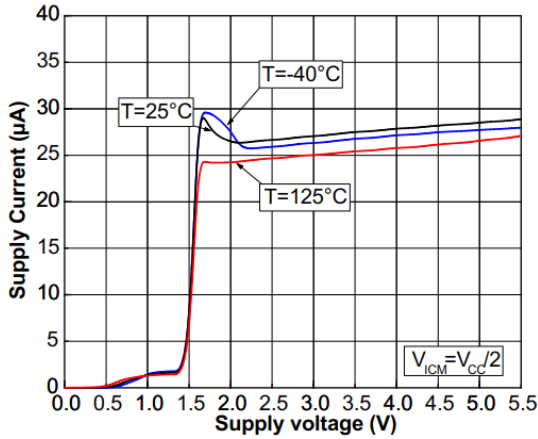

Figure 3. Input offset voltage distribution at  $V_{CC} = 5\text{ V}$

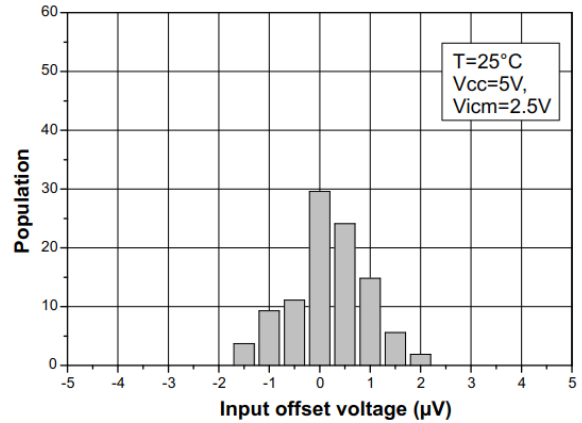

Figure 4. Input offset voltage distribution at  $V_{CC} = 3.3\text{ V}$

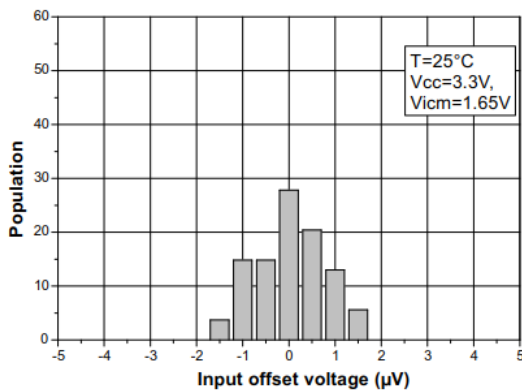

Figure 5. Input offset voltage distribution at  $V_{CC} = 1.8\text{ V}$

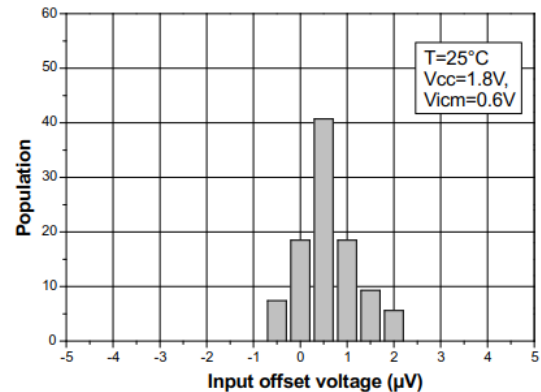

Figure 6. Vio temperature co-efficient distribution (-40  $^\circ\text{C}$  to 25  $^\circ\text{C}$ )

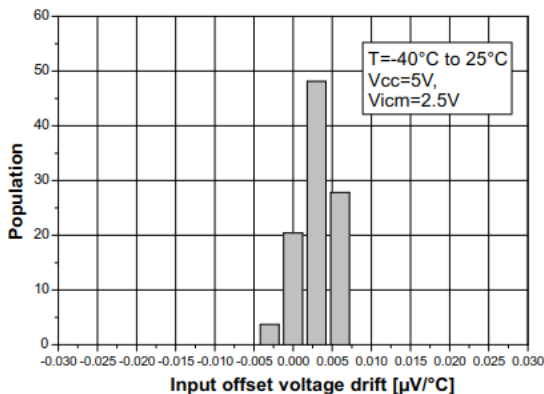

Figure 7. Vio temperature co-efficient distribution (25  $^\circ\text{C}$  to 125  $^\circ\text{C}$ )

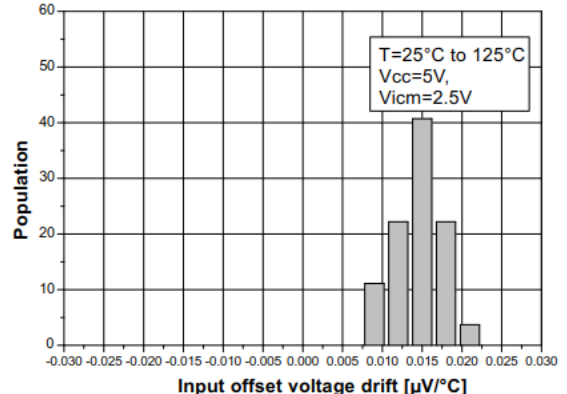

Figure 8. Input offset voltage vs. supply voltage

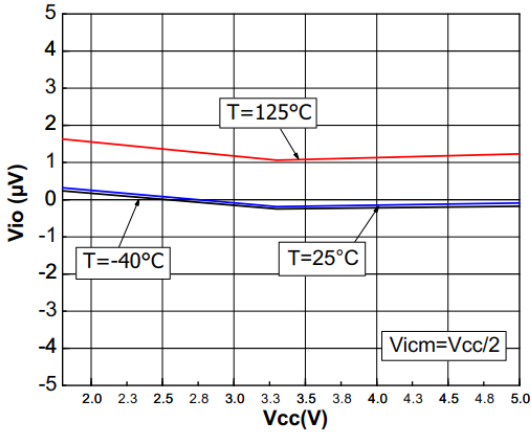

Figure 9. Input offset voltage vs. input common-mode at  $V_{CC} = 1.8\text{ V}$

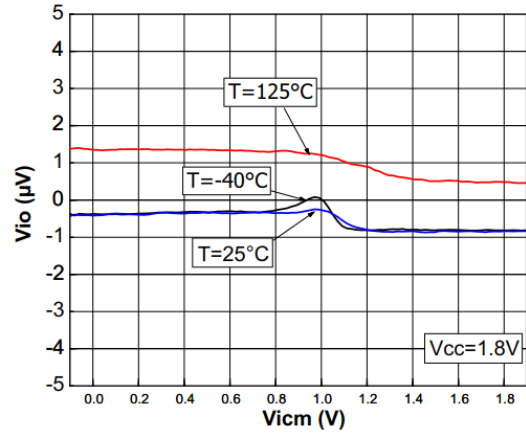

Figure 10. Input offset voltage vs. input common-mode at  $V_{CC} = 2.7\text{ V}$

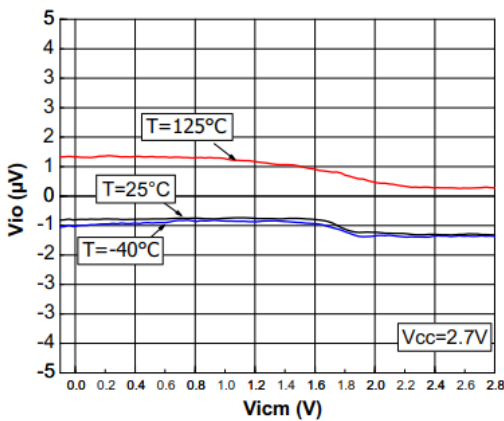

Figure 11. Input offset voltage vs. input common-mode at  $V_{CC} = 5.5\text{ V}$

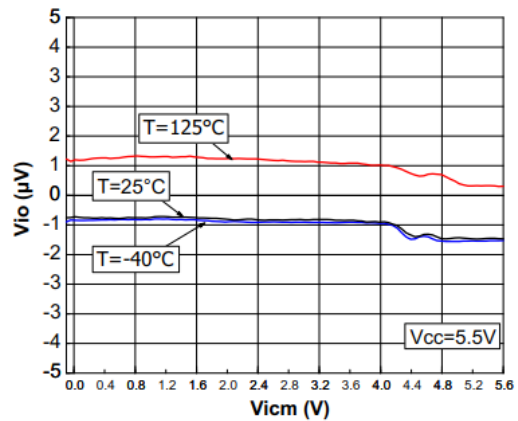

Figure 12. Input offset voltage vs. temperature

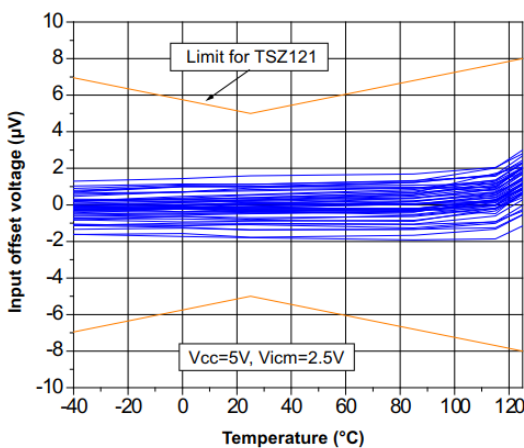

Figure 13.  $V_{OH}$  vs. supply voltage

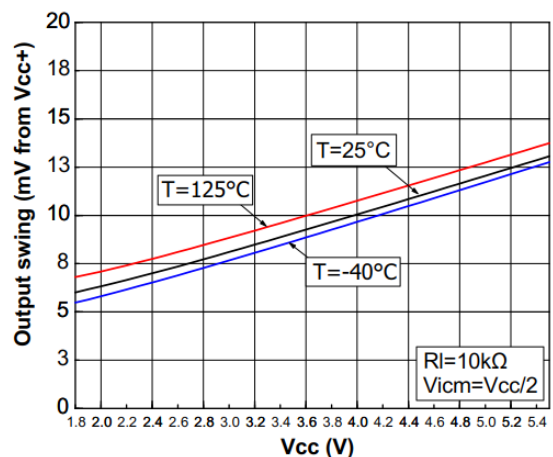



Figure 14.  $V_{OL}$  vs. supply voltage

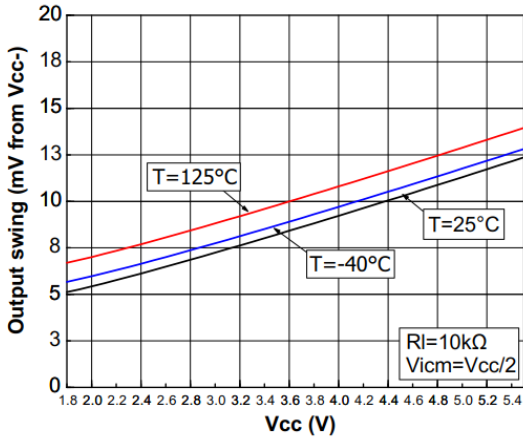

Figure 15. Output current vs. output voltage at  $V_{CC} = 1.8\text{ V}$

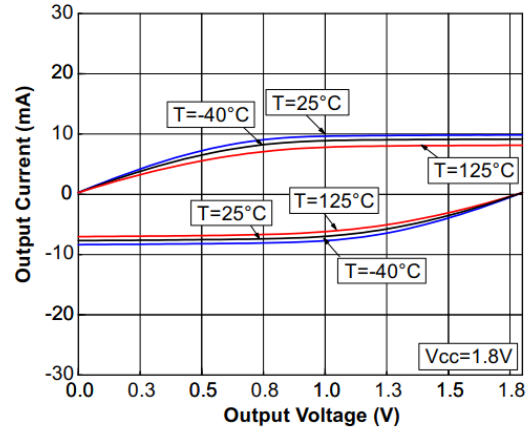

Figure 16. Output current vs. output voltage at  $V_{CC} = 5.5\text{ V}$

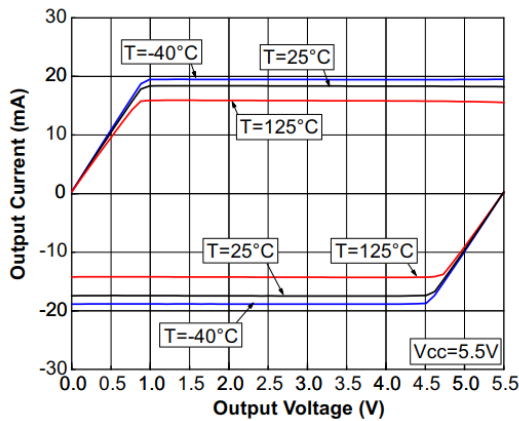

Figure 17. Input bias current vs. common mode at  $V_{CC} = 5\text{ V}$

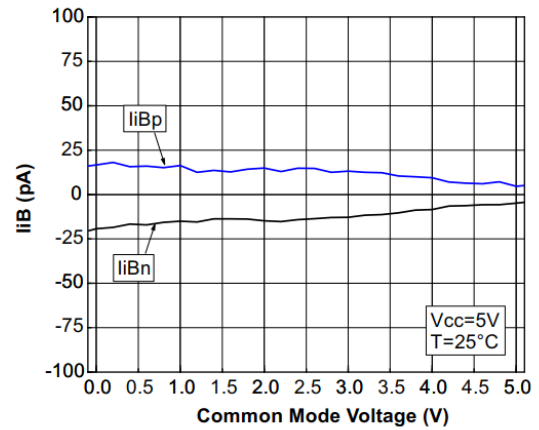

Figure 18. Input bias current vs. common mode at  $V_{CC} = 1.8\text{ V}$

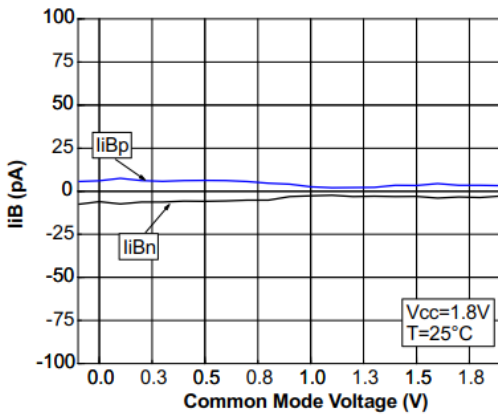

Figure 19. Input bias current vs. temperature at  $V_{CC} = 5\text{ V}$

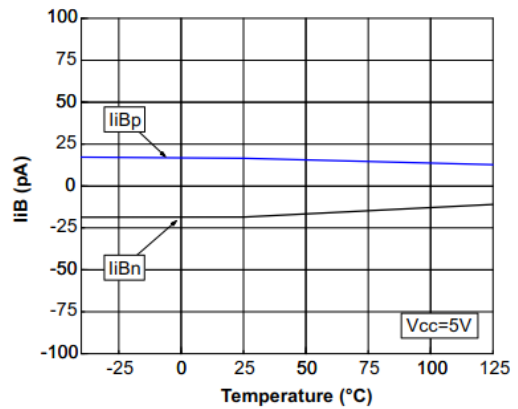

Figure 20. Bode diagram at  $V_{CC} = 1.8$  V

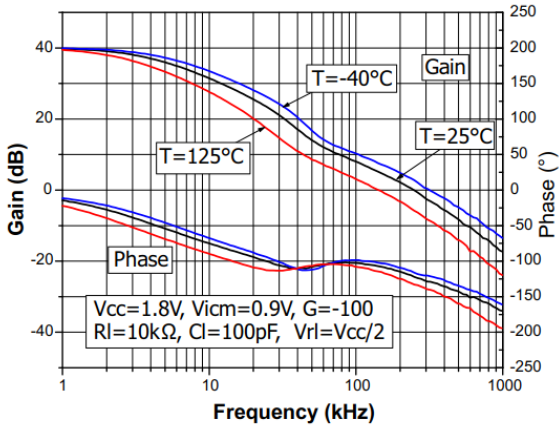

Figure 21. Bode diagram at  $V_{CC} = 2.7$  V

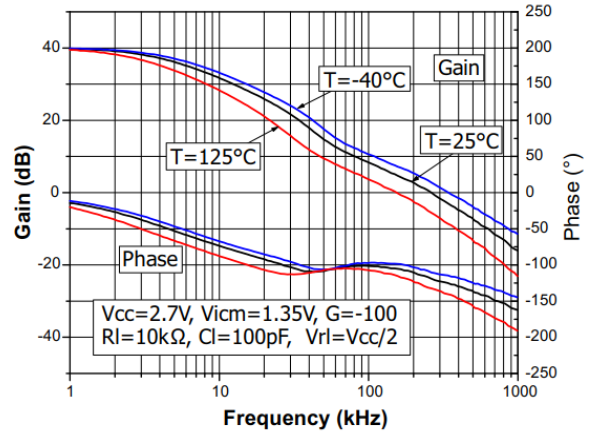

Figure 22. Bode diagram at  $V_{CC} = 5.5$  V

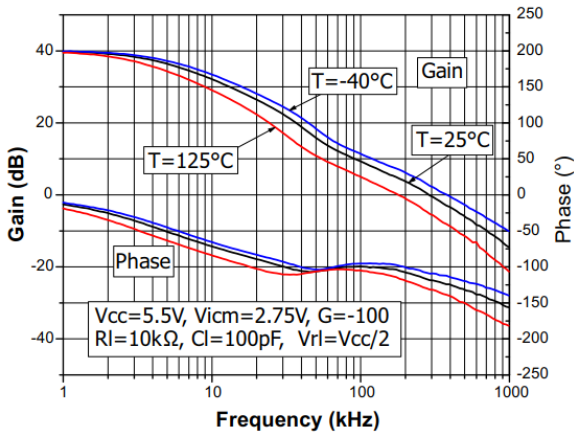

Figure 23. Open loop gain vs. frequency

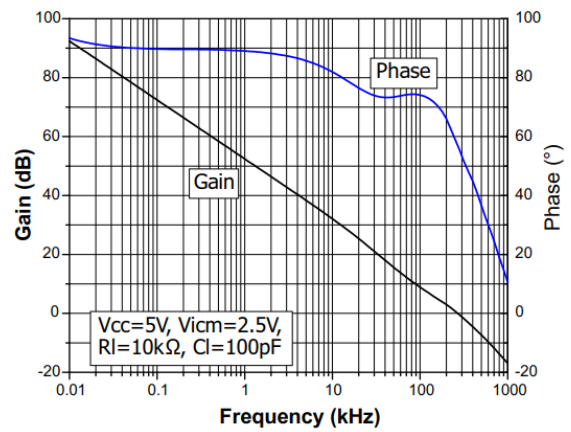

Figure 24. Positive slew rate vs. supply voltage

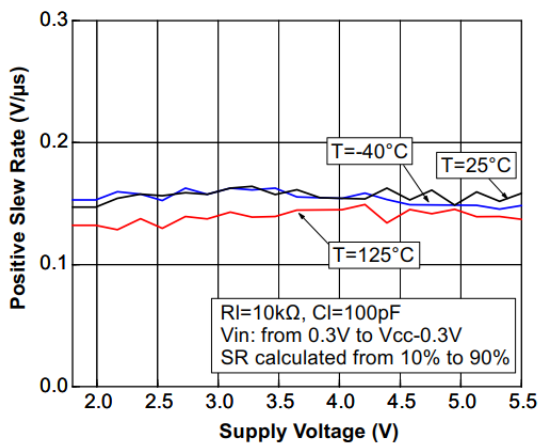
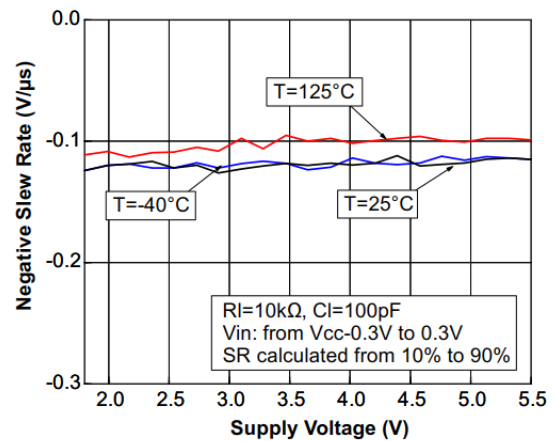

Figure 25. Negative slew rate vs. supply voltage



Very high accuracy (5  $\mu$ V) zero drift micropower 5 V operational amplifiers

Figure 26. 0.1 Hz to 10 Hz noise

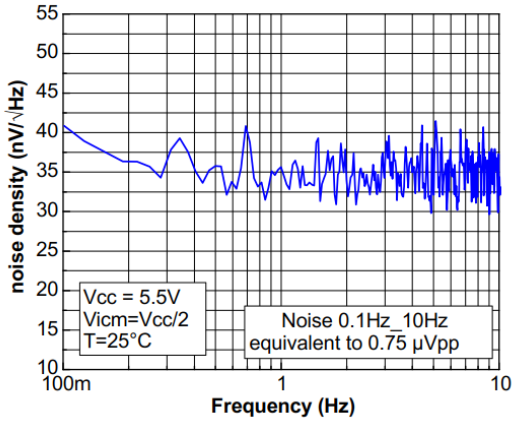

Figure 27. Noise vs. frequency

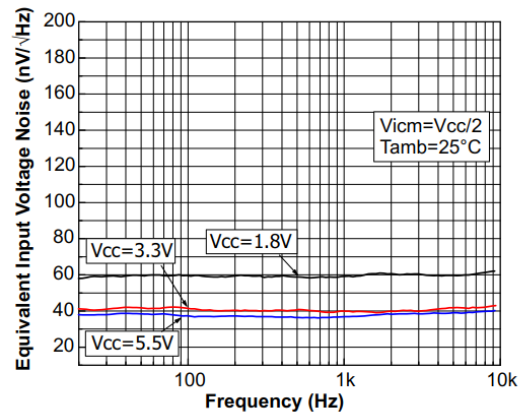

Figure 28. Noise vs. frequency and temperature

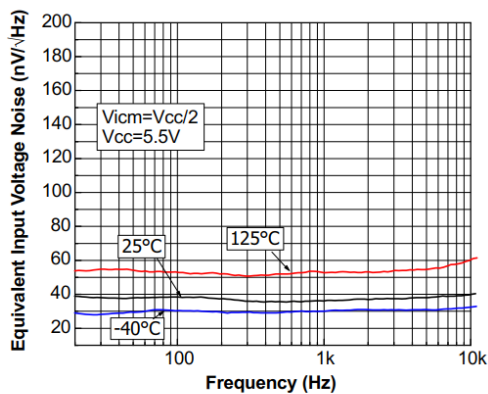

Figure 29. Output overshoot vs. load capacitance

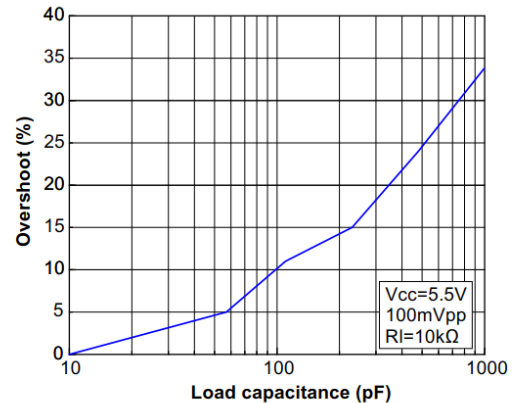

Figure 30. Small signal

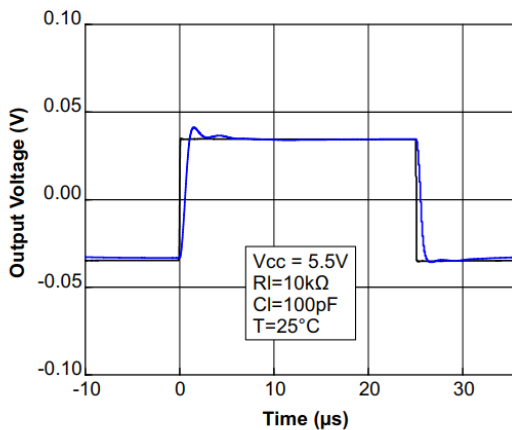
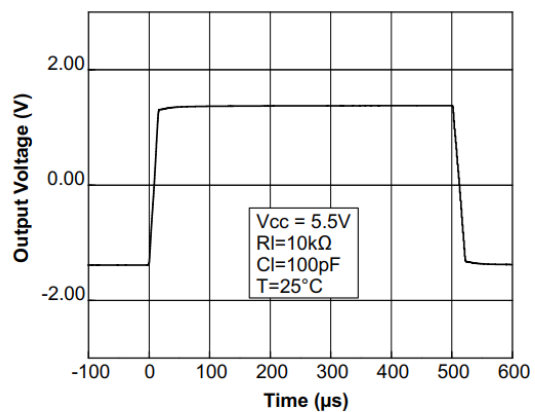

Figure 31. Large signal



Very high accuracy (5  $\mu$ V) zero drift micropower 5 V operational amplifiers

Figure 32. Positive overvoltage recovery at  $V_{CC} = 1.8$  V

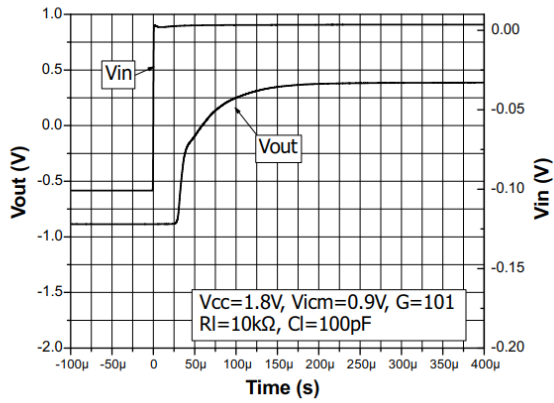

Figure 33. Positive overvoltage recovery at  $V_{CC} = 5$  V

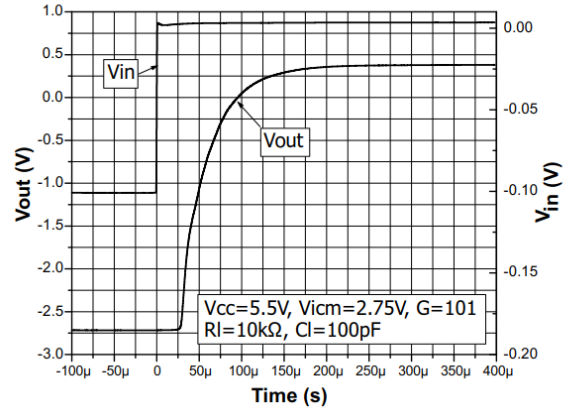

Figure 34. Negative overvoltage recovery at  $V_{CC} = 1.8$  V

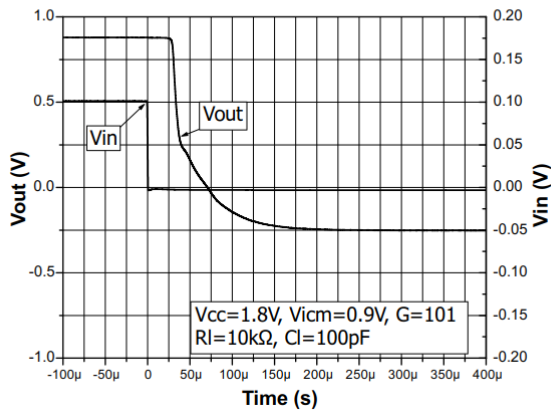

Figure 35. Negative overvoltage recovery at  $V_{CC} = 5$  V

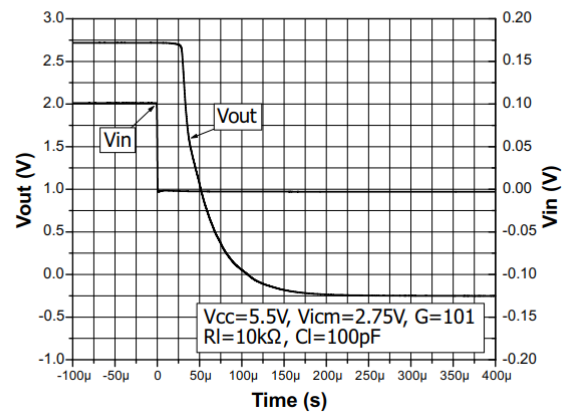

Figure 36. PSRR vs. frequency

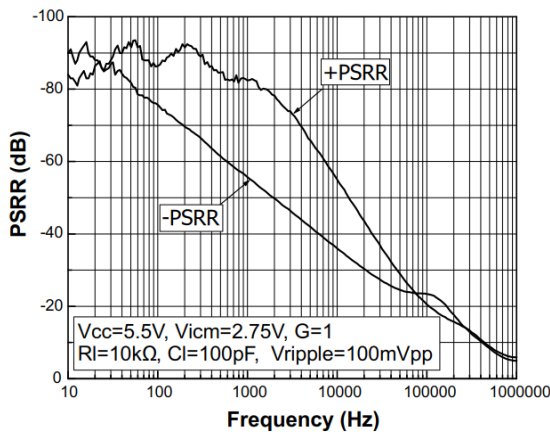
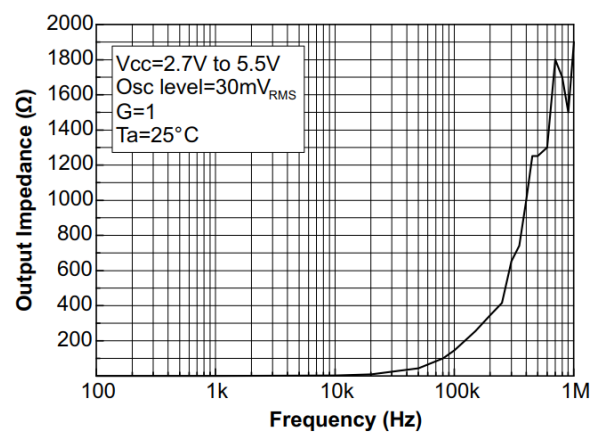
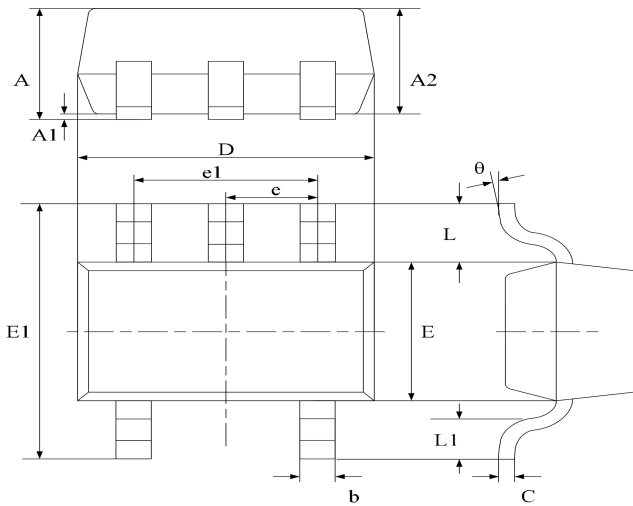

Figure 37. Output impedance vs. frequency



Package Dimension

SC70-5 (SOT353)



Symbol	Dimensions In Millimeters		Dimensions In Inches	
	Min	Max	Min	Max
A	0.800	1.100	0.035	0.043
A1	0.000	0.100	0.000	0.004
A2	0.800	0.900	0.035	0.039
b	0.150	0.350	0.006	0.014
C	0.080	0.150	0.003	0.006
D	1.8500	2.150	0.079	0.087
E	1.100	1.400	0.045	0.053
E1	1.950	2.200	0.085	0.096
e	0.850 typ.		0.026 typ.	
e1	1.200	1.400	0.047	0.055
L	0.42 ref.		0.021 ref.	
L1	0.260	0.460	0.010	0.018
$\theta$	0°	8°	0°	8°

SOT23-5

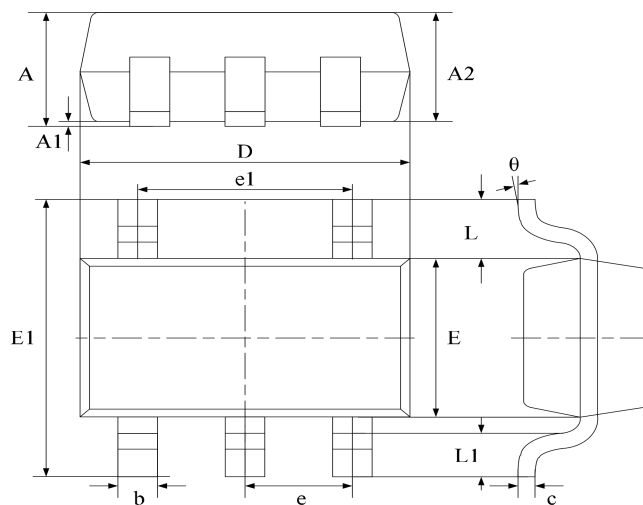

Symbol	Dimensions In Millimeters		Dimensions In Inches	
	Min	Max	Min	Max
A	1.040	1.350	0.042	0.055
A1	0.040	0.150	0.002	0.006
A2	1.000	1.200	0.041	0.049
b	0.380	0.480	0.015	0.020
c	0.110	0.210	0.004	0.009
D	2.720	3.120	0.111	0.127
E	1.400	1.800	0.057	0.073
E1	2.600	3.000	0.106	0.122
e	0.950 typ.		0.037 typ.	
e1	1.900 typ.		0.078 typ.	
L	0.700 ref.		0.028 ref.	
L1	0.300	0.600	0.012	0.024
$\theta$	0°	8°	0°	8°

SOP-8

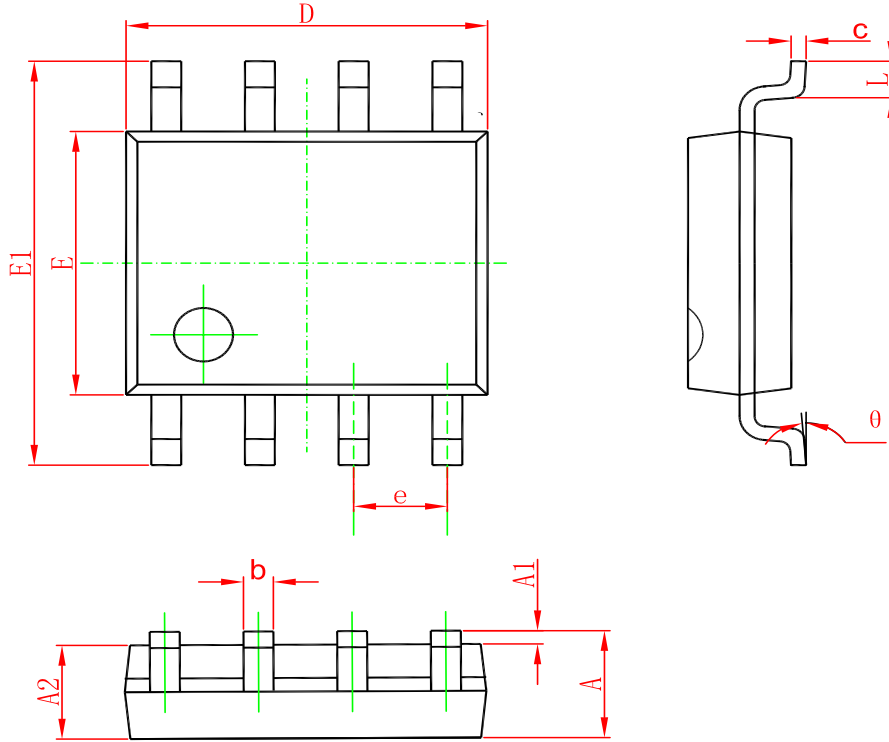

Symbol	Dimensions In Millimeters		Dimensions In Inches	
	Min	Max	Min	Max
A	1.350	1.750	0.053	0.069
A1	0.100	0.250	0.004	0.010
A2	1.350	1.550	0.053	0.061
b	0.330	0.510	0.013	0.020
c	0.170	0.250	0.006	0.010
D	4.700	5.100	0.185	0.200
E	3.800	4.000	0.150	0.157
E1	5.800	6.200	0.228	0.244
e	1.270(BSC)		0.050(BSC)	
L	0.400	1.270	0.016	0.050
θ	0°	8°	0°	8°

### Ordering information

Order code	Package	Baseqty	Deliverymode	Maring
UMW TSZ121IYLT	SOT23-5	3000	Tape and reel	K192 U
UMW TSZ122IYDT	SOP-8	2500	Tape and reel	TSZ122
UMW TSZ122IDT	SOP-8	2500	Tape and reel	TSZ122
UMW TSZ121ICT	SC70-5	3000	Tape and reel	K44 U