

General Description

The WSM350N04 is the highest performance trench N-Ch MOSFET with extreme high cell density, which provide excellent R_{DS(on)} and gate charge for most of the synchronous buck converter applications.

The WSM350N04 meet the RoHS and Green Product requirement, 100% EAS guaranteed with full function reliability approved.

Features

- Advanced high cell density Trench technology
- Super Low Gate Charge
- Excellent CdV/dt effect decline
- 100% EAS Guaranteed
- Green Device Available

Product Summary

BV _{DSS}	R _{DS(on)}	I _D
40V	1.0mΩ	350A

Applications

- Synchronous Rectification
- Networking DC-DC Power System
- Load Switch

TOLLA-8L Pin Configuration



Absolute Maximum Ratings

Symbol	Parameter	Rating	Units
V _{DS}	Drain-Source Voltage	40	V
V _{GS}	Gate-Source Voltage	±20	V
I _D @T _C =25°C	Continuous Drain Current, V _{GS} @ 10V	350	A
I _D @T _C =100°C	Continuous Drain Current, V _{GS} @ 10V	210	A
I _{DM}	Pulsed Drain Current T _C =25°C	585	A
EAS	Avalanche Energy, Single pulse, L=0.1mH	1125	mJ
I _{AS}	Avalanche Current, Single pulse, L=0.1mH	150	A
P _D @T _C =25°C	Total Power Dissipation	104	W
P _D @T _C =100°C	Total Power Dissipation	42	W
T _{STG}	Storage Temperature Range	-55 to 150	°C
T _J	Operating Junction Temperature Range	-55 to 150	°C

Thermal Data

Symbol	Parameter	Typ.	Max.	Unit
R _{θJA}	Thermal Resistance Junction-Ambient	---	58	°C/W
R _{θJC}	Thermal Resistance Junction-Case	---	1.2	°C/W

Electrical Characteristics (T_J=25 °C, unless otherwise noted)

Symbol	Parameter	Conditions	Min.	Typ.	Max.	Unit
BV _{DSS}	Drain-Source Breakdown Voltage	V _{GS} =0V, I _D =250μA	40	---	---	V
ΔBV _{DSS} /ΔT _J	BV _{DSS} Temperature Coefficient	Reference to 25°C, I _D =1mA	---	0.096	---	V/°C
R _{DS(ON)}	Static Drain-Source On-Resistance	V _{GS} =10V, I _D =25A	---	1.0	1.5	mΩ
		V _{GS} =4.5V, I _D =15A	---	1.5	2.0	mΩ
V _{GS(th)}	Gate Threshold Voltage	V _{GS} =V _{DS} , I _D =250μA	1.3	1.7	2.5	V
ΔV _{GS(th)}	V _{GS(th)} Temperature Coefficient		---	-5.5	---	mV/°C
I _{DSS}	Drain-Source Leakage Current	V _{DS} =40V, V _{GS} =0V, T _J =25°C	---	---	1	μA
		V _{DS} =40V, V _{GS} =0V, T _J =55°C	---	---	10	
I _{GSS}	Gate-Source Leakage Current	V _{GS} =±25V, V _{DS} =0V	---	---	±100	nA
R _g	Gate Resistance	V _{DS} =0V, V _{GS} =0V, f=1MHz	---	1.0	---	Ω
Q _g	Total Gate Charge (10V)	V _{DS} =20V, V _{GS} =10V, I _D =25A	---	50	---	nC
Q _{gs}	Gate-Source Charge		---	12	---	
Q _{gd}	Gate-Drain Charge		---	11	---	
T _{d(on)}	Turn-On Delay Time	V _{DD} =20V, V _{GS} =10V, R _G =6Ω, R _L =20Ω, I _{DS} =1A.	---	19	---	ns
T _r	Rise Time		---	10	---	
T _{d(off)}	Turn-Off Delay Time		---	58	---	
T _f	Fall Time		---	51	---	
C _{iss}	Input Capacitance	V _{DS} =20V, V _{GS} =0V, f=1MHz	---	9500	---	pF
C _{oss}	Output Capacitance		---	4500	---	
C _{rss}	Reverse Transfer Capacitance		---	3200	---	

Diode Characteristics

Symbol	Parameter	Conditions	Min.	Typ.	Max.	Unit
I _S	Continuous Source Current	V _G =V _D =0V, Force Current	---	---	200	A
V _{SD}	Diode Forward Voltage	V _{GS} =0V, I _S =25A, T _J =25°C	---	---	1.2	V

A: The value of R_{θJA} is measured with the device mounted on 1in² FR-4 board with 2oz. Copper, in a still air environment with T_A=25°C. The value in any given application depends on the user's specific board design.

B: Repetitive rating, pulse width limited by junction temperature.

C: The current rating is based on the t_s 10s junction to ambient thermal resistance rating.

Typical Operating Characteristics

Power Dissipation

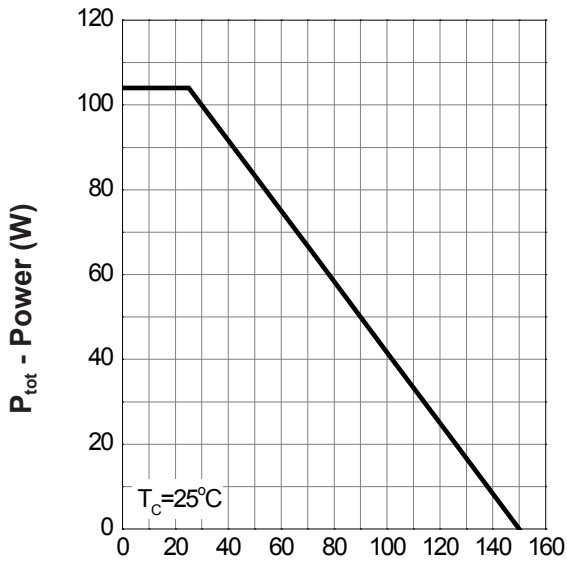

T_j - Junction Temperature (°C)

Drain Current

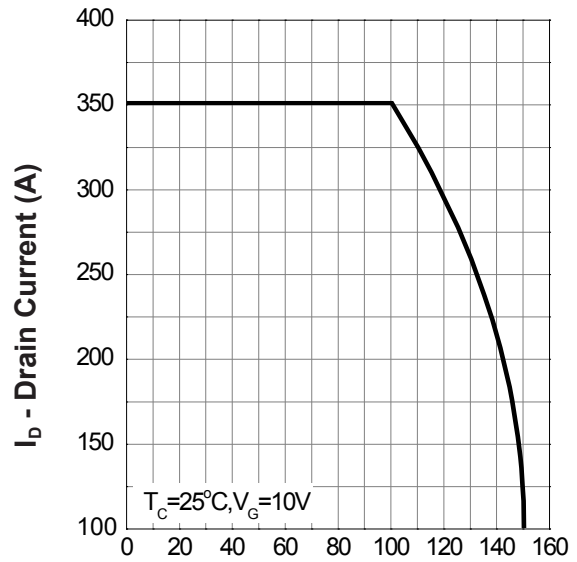

T_j - Junction Temperature (°C)

Gate-Source On Resistance

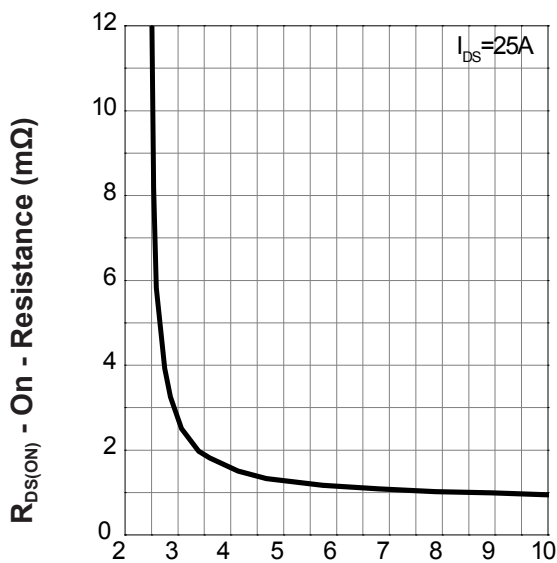

V_{GS} - Gate - Source Voltage (V)

Gate Threshold Voltage

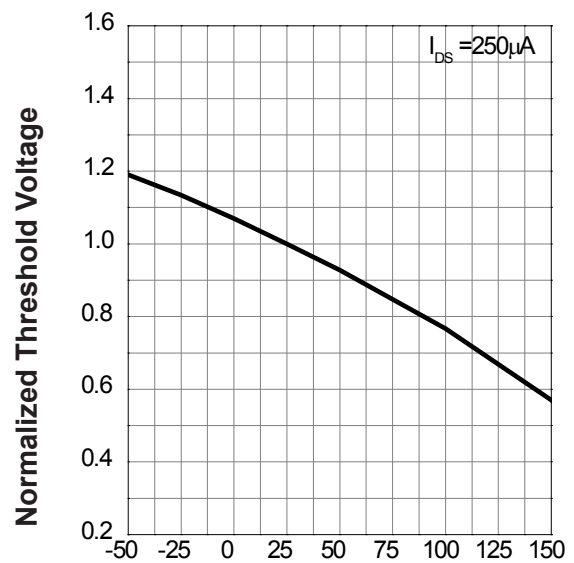

T_j - Junction Temperature (°C)

Typical Operating Characteristics

Safe Operation Area

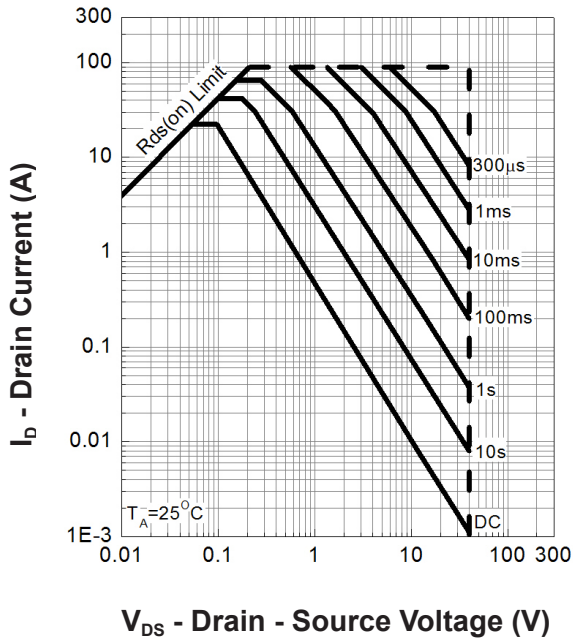

Thermal Transient Impedance

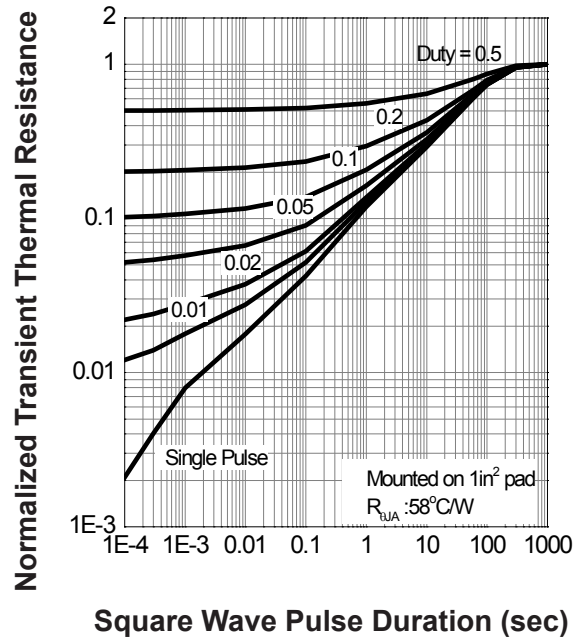

Output Characteristics

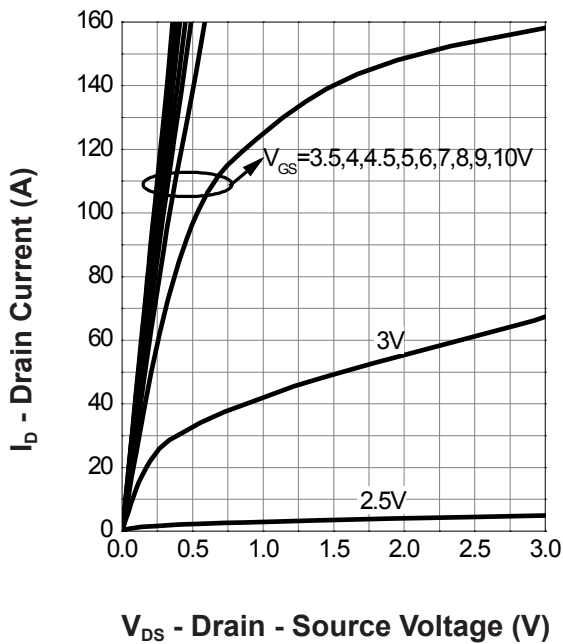

Drain-Source On Resistance

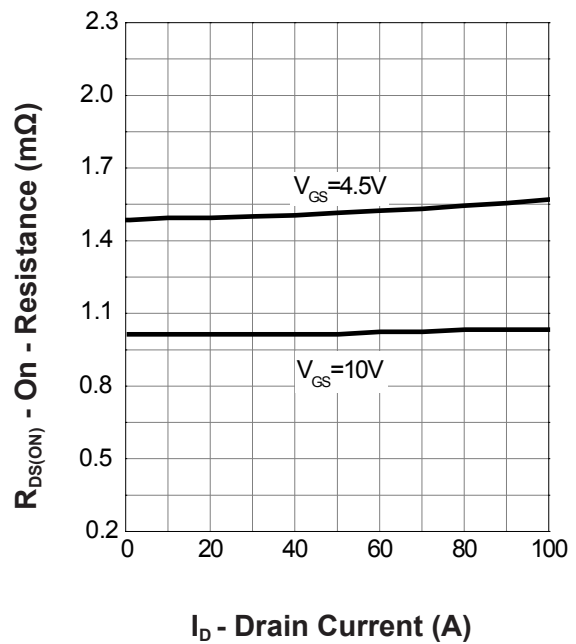

Typical Operating Characteristics

Capacitance

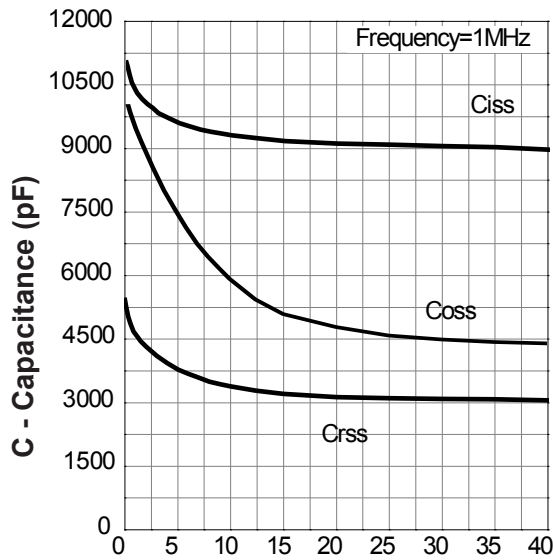

V_{DS} - Drain-Source Voltage (V)

Gate Charge

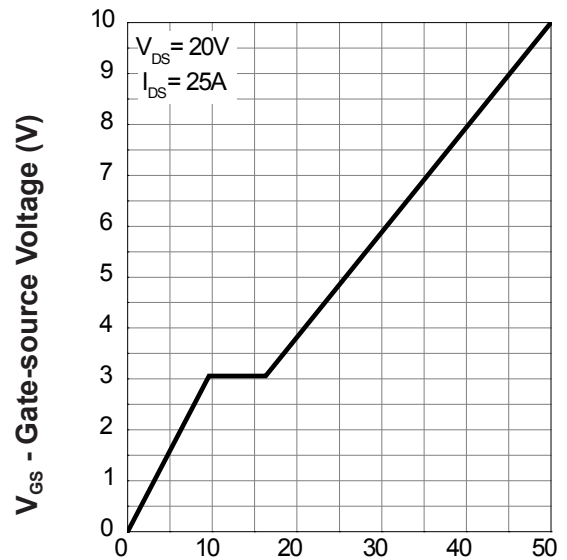

Q_G - Gate Charge (nC)

Drain-Source On Resistance

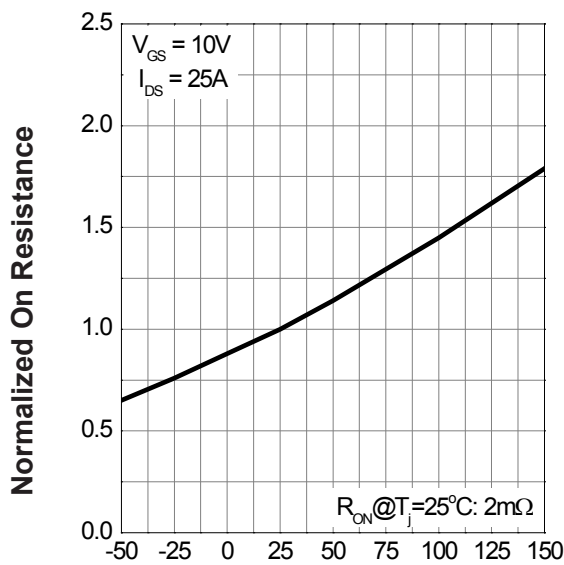

T_j - Junction Temperature (°C)

Source-Drain Diode Forward

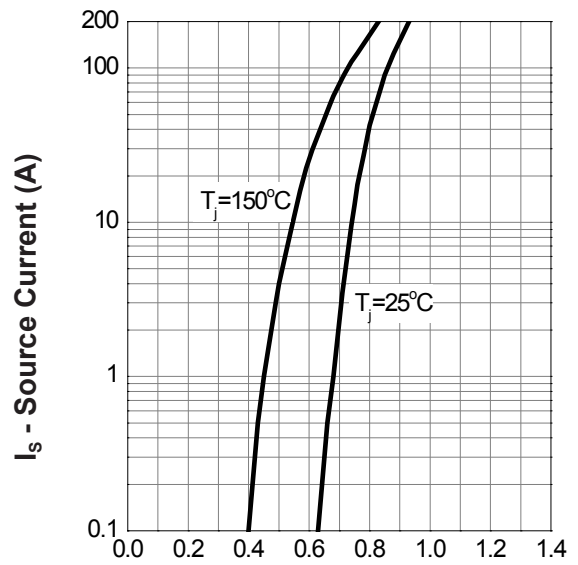

V_{SD} - Source - Drain Voltage (V)

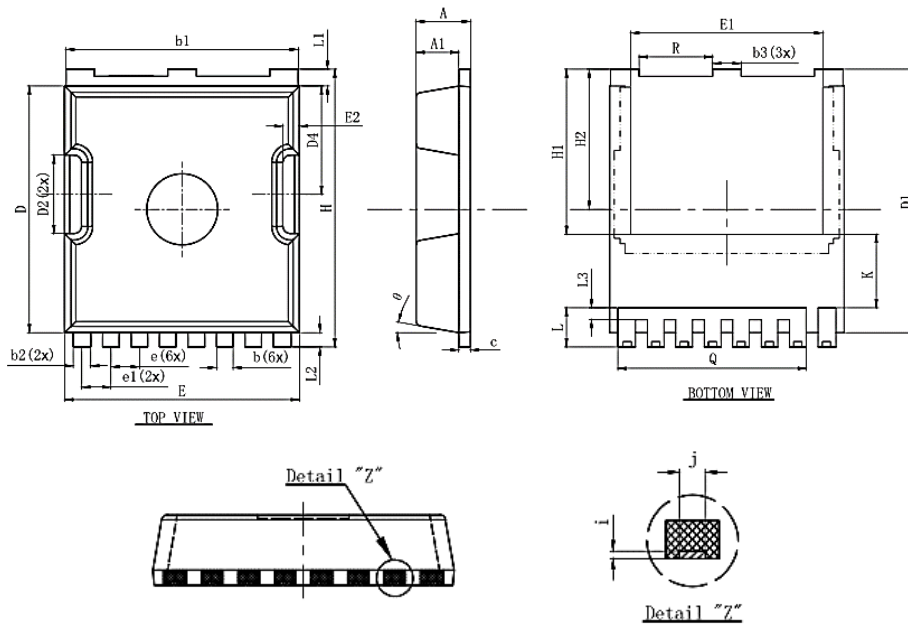
Packaging information

Symbol	Dimensions In Millimeters		
	Min.	Nom	Max.
A	2.2	2.3	2.4
A1	1.7	1.8	1.9
b	0.6	0.7	0.8
b1	9.7	9.8	9.9
b2	0.65	0.75	0.85
b3	1.1	1.2	1.3
C	0.4	0.5	0.6
D	10.3	10.4	10.5
D1	11.0	11.1	11.2
D2	3.2	3.3	3.4
D4	4.47	4.57	4.67
E	9.8	9.9	10.0
E1	8.0	8.1	8.2
E2	0.5	0.6	0.7
e	1.200 (BSC)		
e1	1.225 (BSC)		
H	11.6	11.7	11.8
H1	6.95BSC		
H2	5.9BSC		
i	0.1REF		
j	0.350REF		
K	3.100REF		
L	1.55	1.65	1.75
L1	0.6	0.7	0.8
L2	0.5	0.6	0.7
L3	0.4	0.5	0.6
Q	7.95REF		
R	3.0	3.1	3.2
θ	10°REG		



Attention

- 1, Any and all Winsok power products described or contained herein do not have specifications that can handle applications that require extremely high levels of reliability, such as life-support systems, aircraft's control systems, or other applications whose failure can be reasonably expected to result in serious physical and/or material damage. Consult with your Winsok power representative nearest you before using any Winsok power products described or contained herein in such applications.
- 2, Winsok power assumes no responsibility for equipment failures that result from using products at values that exceed, even momentarily, rated values (such as maximum ratings, operating condition ranges, or other parameters) listed in products specifications of any and all Winsok power products described or contained herein.
- 3, Specifications of any and all Winsok power products described or contained herein stipulate the performance, characteristics, and functions of the described products in the independent state, and are not guarantees of the performance, characteristics, and functions of the described products as mounted in the customer's products or equipment. To verify symptoms and states that cannot be evaluated in an independent device, the customer should always evaluate and test devices mounted in the customer's products or equipment.
- 4, Winsok power Semiconductor CO., LTD. strives to supply high-quality high-reliability products. However, any and all semiconductor products fail with some probability. It is possible that these probabilistic failures could give rise to accidents or events that could endanger human lives that could give rise to smoke or fire, or that could cause damage to other property. When designing equipment, adopt safety measures so that these kinds of accidents or events cannot occur. Such measures include but are not limited to protective circuits and error prevention circuits for safe design, redundant design, and structural design.
- 5, In the event that any or all Winsok power products (including technical data, services) described or contained herein are controlled under any of applicable local export control laws and regulations, such products must not be exported without obtaining the export license from the authorities concerned in accordance with the above law.
- 6, No part of this publication may be reproduced or transmitted in any form or by any means, electronic or mechanical, including photocopying and recording, or any information storage or retrieval system, or otherwise, without the prior written permission of Winsok power Semiconductor CO., LTD.
- 7, Information (including circuit diagrams and circuit parameters) herein is for example only; it is not guaranteed for volume production. Winsok power believes information herein is accurate and reliable, but no guarantees are made or implied regarding its use or any infringements of intellectual property rights or other rights of third parties.
- 8, Any and all information described or contained herein are subject to change without notice due to product/technology improvement, etc. When designing equipment, refer to the "Delivery Specification" for the Winsok power product that you intend to use.
- 9, this catalog provides information as of Sep. 2014. Specifications and information herein are subject to change without notice.