

1 Ampere Surface Mount Schottky Barrier Rectifier



SS12F-SS120F

Features:

- Metal silicon junction, majority carrier conduction
- For surface mounted applications
- Low power loss, high efficiency
- Fast switching for high efficiency
- High forward surge current capability
- For use in low voltage, high frequency inverters

SMAF

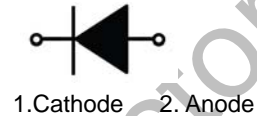

Absolute Maximum Ratings and Electrical characteristics

Ratings at 25 °C ambient temperature unless otherwise specified. Single phase, half wave, 60Hz resistive or inductive load, for capacitive load, derate by 20 %

Parameter	Symbols	SS12F	SS14F	SS16F	SS18F	SS110F	SS112F	SS115F	SS120F	Units
Maximum Repetitive Peak Reverse Voltage	V_{RRM}	20	40	60	80	100	120	150	200	V
Maximum RMS voltage	V_{RMS}	14	28	42	56	70	84	105	140	V
Maximum DC Blocking Voltage	V_{DC}	20	40	60	80	100	120	150	200	V
Maximum Average Forward Rectified Current	$I_{F(AV)}$	1.0								A
Peak Forward Surge Current, 8.3ms Single Half Sine-wave Superimposed on Rated Load (JEDEC method)	I_{FSM}	25								A
Max Instantaneous Forward Voltage at 1 A	V_F	0.55	0.70	0.85			0.90		V	
Maximum DC Reverse Current $T_a = 25^\circ\text{C}$ at Rated DC Reverse Voltage $T_a = 100^\circ\text{C}$	I_R	0.3		0.2			0.1		mA	
		10		5			2			
Typical Junction Capacitance ⁽¹⁾	C_j	110		80					pF	
Typical Thermal Resistance ⁽²⁾	$R_{\theta JA}$	95								°C/W
Operating Junction Temperature Range	T_j	-55 ~ +125								°C
Storage Temperature Range	T_{stg}	-55 ~ +150								°C

(1) Measured at 1 MHz and applied reverse voltage of 4 V D.C

(2) P.C.B. mounted with 2.0" X 2.0" (5 X 5 cm) copper pad areas.

Typical Characteristics

Fig.1 Forward Current Derating Curve

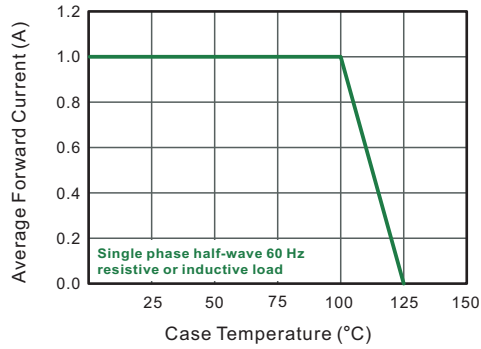

Fig.2 Typical Reverse Characteristics

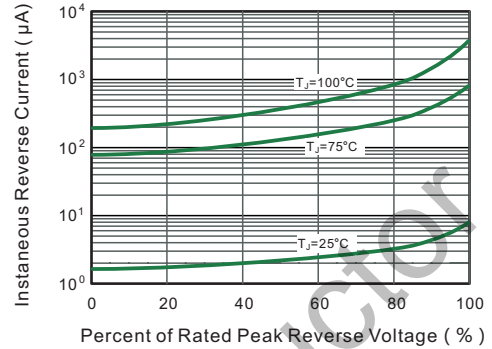

Fig.3 Typical Forward Characteristic

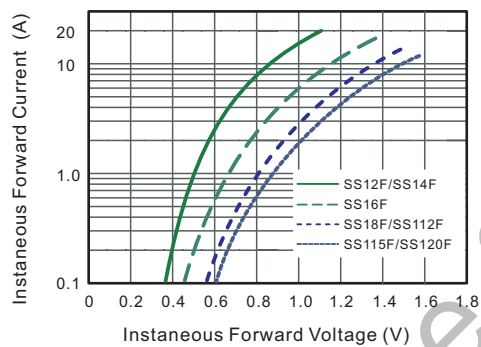

Fig.4 Typical Junction Capacitance

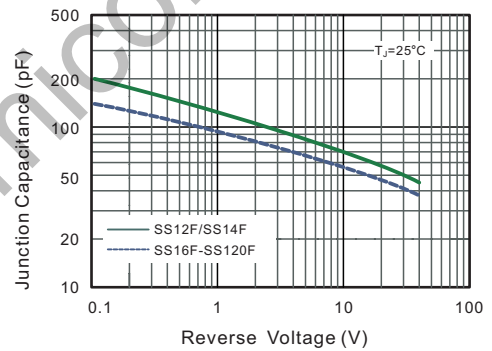

Fig.5 Maximum Non-Repetitive Peak Forward Surge Current

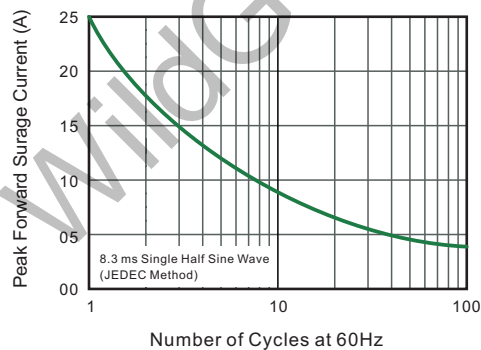
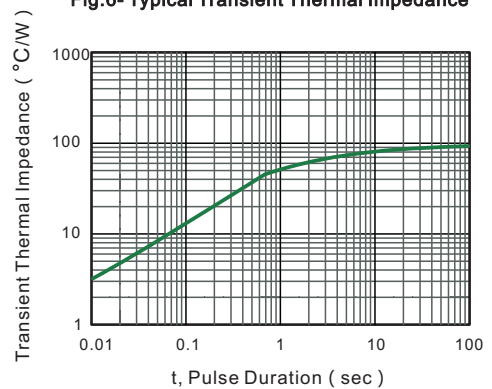

Fig.6- Typical Transient Thermal Impedance



Package Dimension

SMAF

Unit: mm

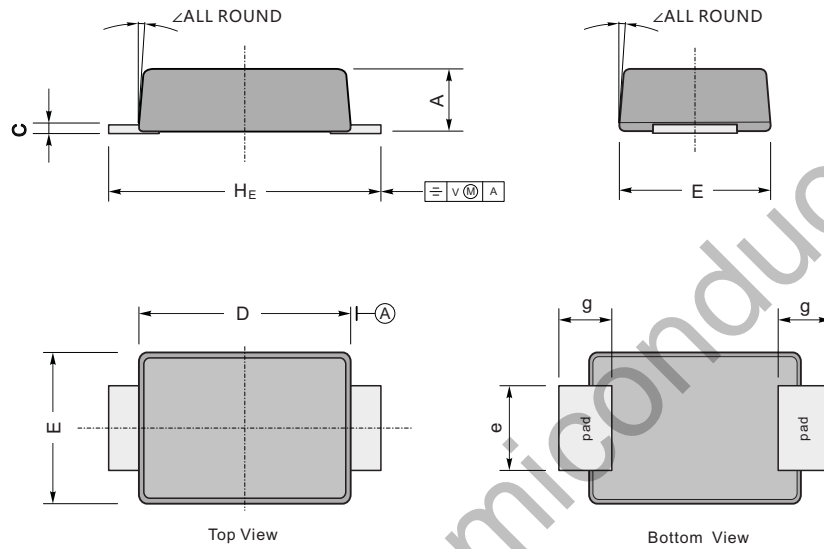

UNIT		A	C	D	E	e	g	H _E	\angle
mm	max	1.2	0.20	3.7	2.7	1.6	1.2	4.9	7°
	min	0.9	0.12	3.3	2.4	1.3	0.8	4.4	
mil	max	47	7.9	146	106	63	47	193	
	min	35	4.7	130	94	51	31	173	

The recommended mounting pad size

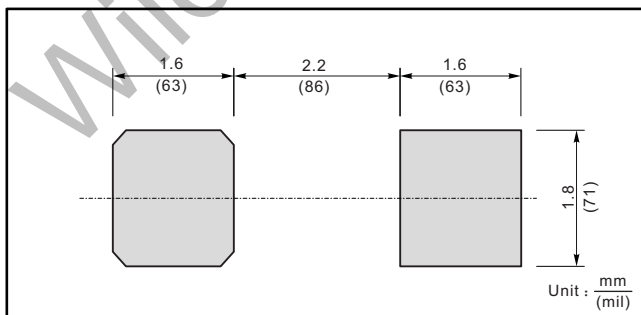

Marking

Type number	Marking code
SS12F	SS12
SS14F	SS14
SS16F	SS16
SS18F	SS18
SS110F	SS110
SS112F	SS112
SS115F	SS115
SS120F	SS120