

A

B

C

D

E

REV.	DESCRIPTION	ECN NO.	NAME	DATE

1

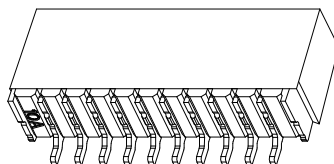
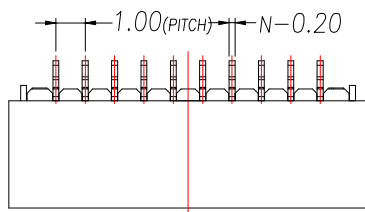

NOTES:

- Working temp:-25°C~85°C.
- Voltage rating:50V AC/DC(rms)
- Contact resistance:40mΩ max.
- Insulation resistance:100MΩ min.
- Current rating:1A AV/DC
- Withstanding Voltage:500V AC/minute
- Pin Retention Force:3N min.
- Housing material:LCP UL94-V0,Natural
- Terminal materl:Brass,
plating Ni 40u" min , plating Tin 100u"min.
- Solder tab material:Brass,
plating Ni 40u" min , plating Tin 100u"min.

2

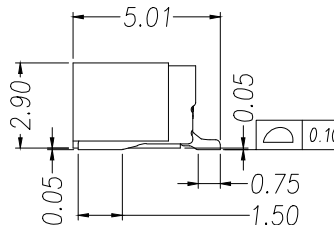
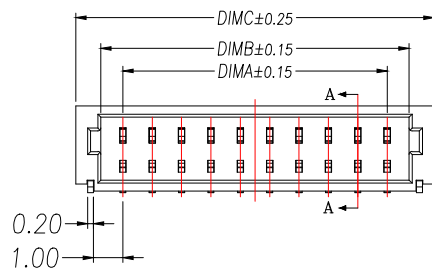

3

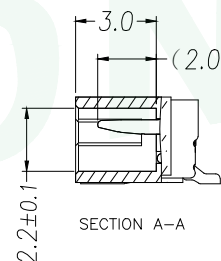
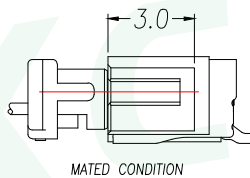
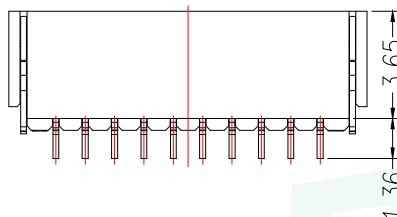

4

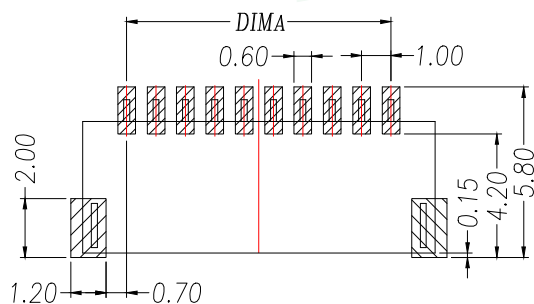



RECOMMENDED PCB LAYOUT TOP VIEW (TOLERANCE:±0.05)

SMT SOLDER AREA

5

PIN	NO.	Dim A	Dim B	Dim C
2	WF-1F11002P	1.00	2.50	4.20
3	WF-1F11003P	2.00	3.50	5.20
4	WF-1F11004P	3.00	4.50	6.20
5	WF-1F11005P	4.00	5.50	7.20
6	WF-1F11006P	5.00	6.50	8.20
7	WF-1F11007P	6.00	7.50	9.20
8	WF-1F11008P	7.00	8.50	10.20
9	WF-1F11009P	8.00	9.50	11.20
10	WF-1F110010P	9.00	10.50	12.20
11	WF-1F110011P	10.00	11.50	13.20
12	WF-1F110012P	11.00	12.50	14.20
13	WF-1F110013P	12.00	13.50	15.20
14	WF-1F110014P	13.00	14.50	16.20
15	WF-1F110015P	14.00	15.50	17.20
16	WF-1F110016P	15.00	16.50	18.20

GENERAL TOLERANCE		DONGGUAN BAOXUN PRECISION TECHNOLOGY CO., LTD					
DIM.	TOL.	TITLE: 线对板插座 SH1.0 卧式贴片					
X		DWG. NO.: WF-1F100ANP				DRAWN: MAX	
X.X	±0.30	PART NO.: WF-1F100ANP				CHECKED: ELLA	
X.XX	±0.25	UNIT: mm				APPROVED: WILL	
X.XXX	±0.15	SCALE: none	SHEET: 1 of 1	DWG. SIZE: A4	LAYER: bxconn		
GENERAL ANGLE:	±3°						

REV.	DESCRIPTION	ECN NO.	NAME	DATE

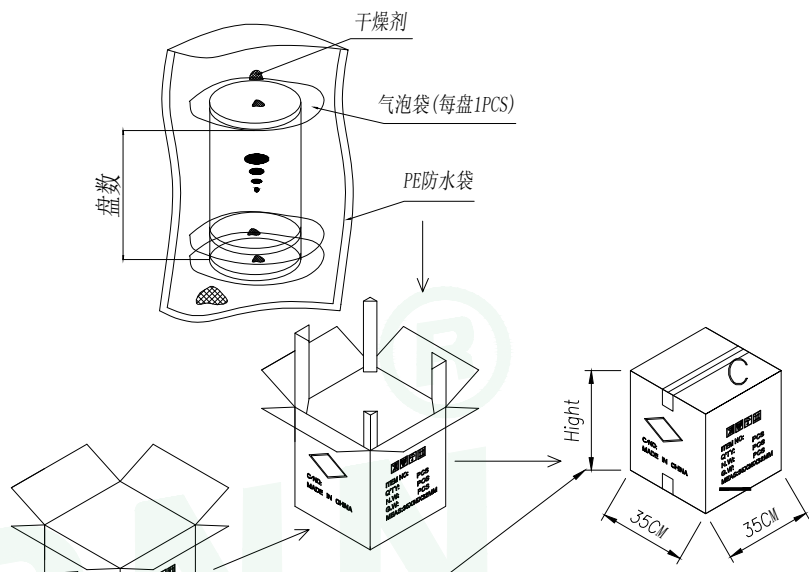
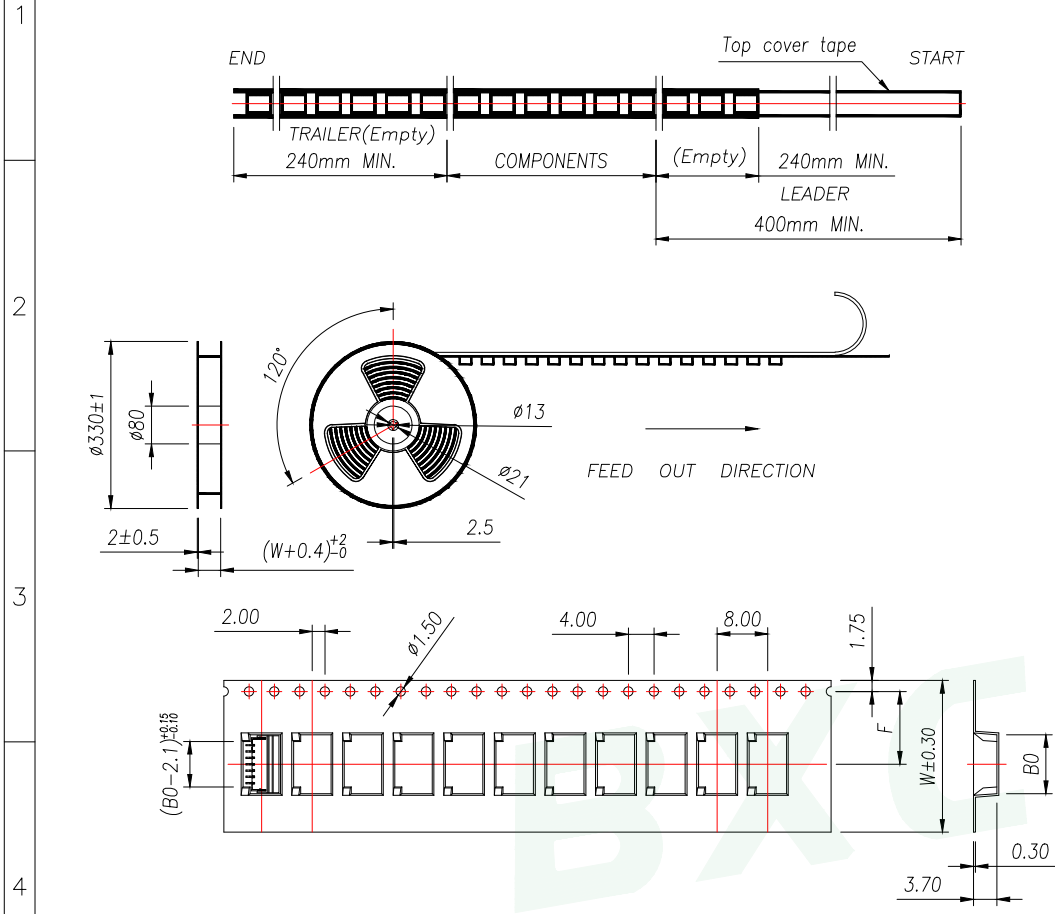

Carton Type	Small Siz	Medium	Standard
Height(CM)	7.5	15	32

NOTE:
 1.10 SPROCKET HOLE PITCH CUMULATIVE TOLERANCE $\pm 0.2\text{mm}$.
 2.CARRIER CAMBER NOT TO EXCEED 1mm IN 100mm.
 3.ALL DIMENSIONS MEET EIA-481 REQUIREMENTS.
 4.MATERIAL: CLEAR ANTISTATIC PS; COLD SEALING.
 5.COMPONENT LOAD PER REEL: 2000 PCS.

PIN	NO.	B0	Dim W	Dim F	PCS/RELL	RELL/CARTON	PCS/CARTON
2	WF-1F11002P	4.30	16	7.50	2000	14	28000
3	WF-1F11003P	5.30					
4	WF-1F11004P	6.30					
5	WF-1F11005P	7.30					
6	WF-1F11006P	8.30	24	11.50	2000	10	20000
7	WF-1F11007P	9.30					
8	WF-1F11008P	10.30					
09	WF-1F11009P	11.30					
10	WF-1F110010P	12.30					
11	WF-1F110011P	13.30					
12	WF-1F110012P	14.30					
13	WF-1F110013P	15.30					

GENERAL TOLERANCE		DONGGUAN BAOXUN PRECISION TECHNOLOGY CO., LTD			
DIM.	TOL.	TITLE: 线对板针座 SH1.0 卧式贴片			
X		DWG. NO.: WF-1F100ANP		DRAWN: MAX	
X.X	± 0.30	PART NO.: WF-1F100ANP		CHECKED: ELLA	
X.XX	± 0.25	UNIT: mm		APPROVED: WILL	
X.XXX	± 0.15	SCALE: none	SHEET: 1 of 1	DWG. SIZE: A4	LAYER: bxcn
GENERAL	ANGLE: $\pm 3^\circ$				



REV.	DESCRIPTION	ECN NO.	NAME	DATE

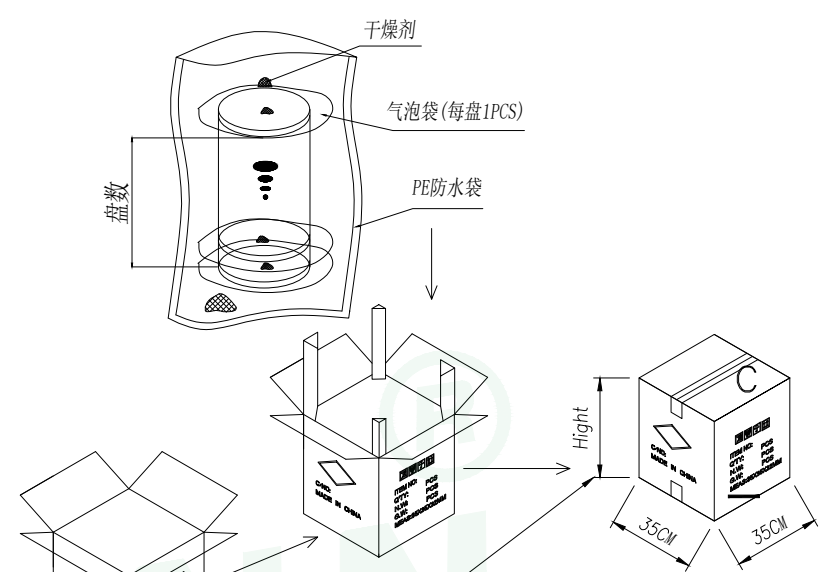
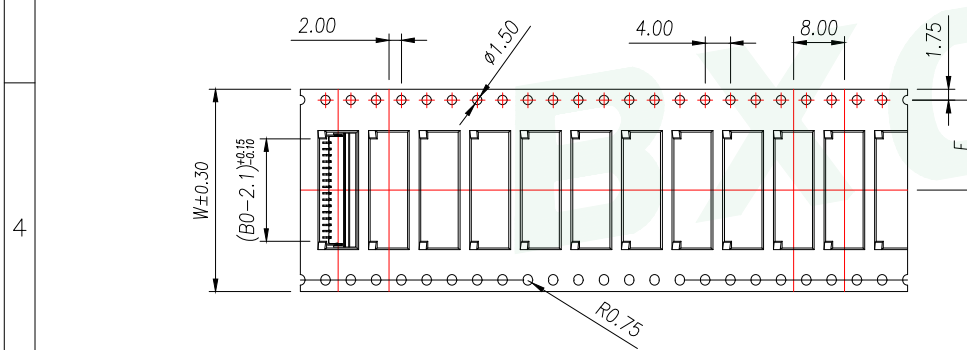
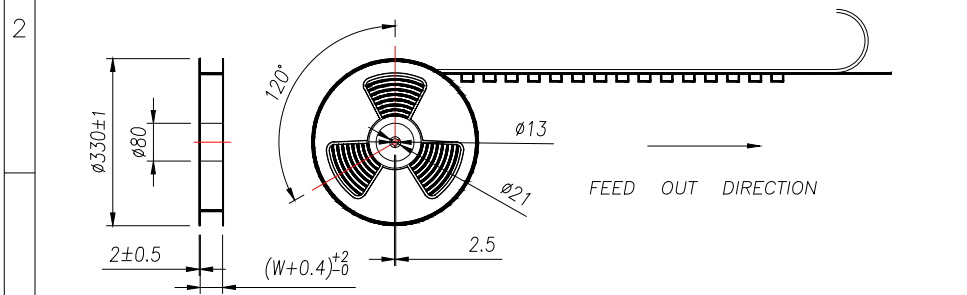
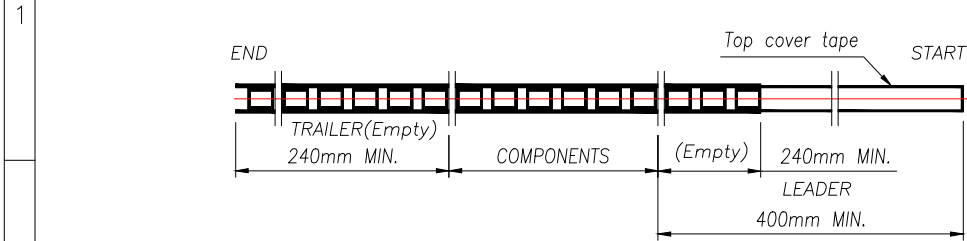

Carton Type	Small Siz	Medium	Standard
Hight(CM)	7.5	15	32

- NOTE:
- 1.10 SPROCKET HOLE PITCH CUMULATIVE TOLERANCE $\pm 0.2\text{mm}$.
 - 2.CARRIER CAMBER NOT TO EXCEED 1mm IN 100mm.
 - 3.ALL DIMENSIONS MEET EIA-481 REQUIREMENTS.
 - 4.MATERIAL: CLEAR ANTISTATIC PS, COLD SEALING.
 - 5.COMPONENT LOAD PER REEL: 2000 PCS.

PIN	NO.	B0	Dim W	Dim F	PCS/RELL	RELL/CARTON	PCS/CARTON
14	WF-1F110014P	16.30	32	14.2	2000	8	16000
15	WF-1F110015P	17.30					
16	WF-1F110016P	18.30					

GENERAL TOLERANCE		DONGGUAN BAOXUN PRECISION TECHNOLOGY CO., LTD			
DIM.	TOL.	TITLE: 线对板针座 SH1.0 卧式贴片			
X		DWG. NO.: WF-1F100ANP		DRAWN: MAX	
X.X	± 0.30	PART NO.: WF-1F100ANP		CHECKED: ELLA	
X.XX	± 0.25	UNIT: mm		APPROVED: WILL	
X.XXX	± 0.15	SCALE: none	SHEET: 1 of 1	DWG. SIZE: A4	LAYER: bxconn
GENERAL ANGLE:	$\pm 3^\circ$				

