

REV.	DESCRIPTION	ECN NO.	NAME	DATE

1
2
3
4
5

NOTES:

- Working temp: -25°C~85°C.
- Voltage rating: 50V AV/DC(rms)
- Contact resistance: 50mΩ max.
- Insulation resistance: 100MΩ min.
- Current rating: 1A AV/DC
- Withstanding Voltage: 500V AC/minute
- Pin Retention Force: 10N min.
- Housing material: LCP UL94-V0, Natural
- Terminal materl: Brass,
plating Ni 50u" min , plating Tin 100u" min.
- Solder tab material: Brass,
plating Ni 50u" min , plating Tin 100u" min.

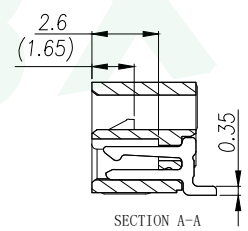
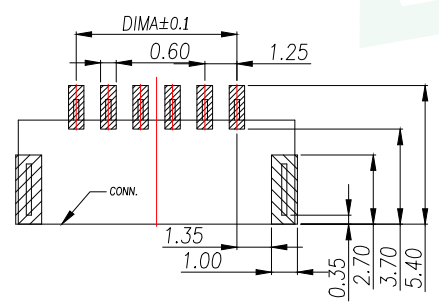
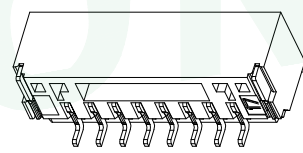
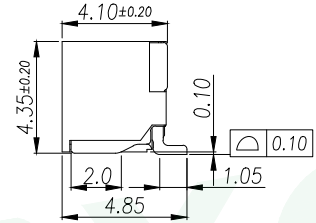
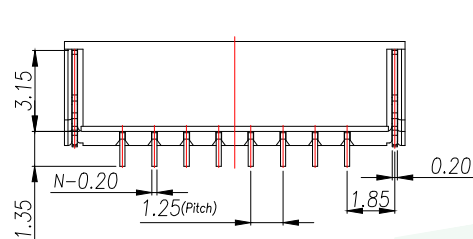
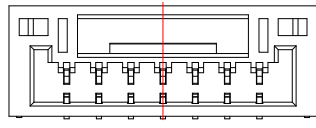
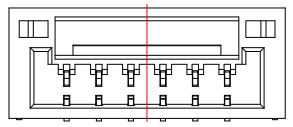
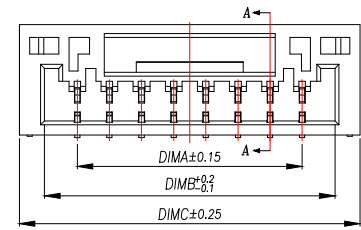

RECOMMENDED PCB LAYOUT TOP VIEW (TOLERANCE:±0.05)
 SMT SOLDER AREA

PIN	NO.	Dim A	Dim B	Dim C
2	WF-1F125B2P	1.25	3.80	5.75
3	WF-1F125B3P	2.50	5.05	7.00
4	WF-1F125B4P	3.75	6.30	8.25
5	WF-1F125B5P	5.00	7.55	9.50
6	WF-1F125B6P	6.25	8.80	10.75
7	WF-1F125B7P	7.50	10.05	12.00
8	WF-1F125B8P	8.75	11.30	13.25
9	WF-1F125B9P	10.00	12.55	14.50
10	WF-1F125B10P	11.25	13.80	15.75
11	WF-1F125B11P	12.50	15.05	17.00
12	WF-1F125B12P	13.75	16.30	18.25
13	WF-1F125B13P	15.00	17.55	19.50
14	WF-1F125B14P	16.25	18.80	20.75
15	WF-1F125B15P	17.50	20.05	22.00
16	WF-1F125B16P	18.75	21.30	23.25

GENERAL TOLERANCE	DONGGUAN BAOXUN PRECISION TECHNOLOGY CO., LTD				
DIM. TOL.	TITLE: 线对板针座 GH1.25 卧式贴片				
X ±0.30	DWG. NO.: WF-1F125BNP		DRAWN: MAX		
X.X ±0.25	PART NO.: WF-1F125BNP		CHECKED: ELLA		
X.XX ±0.15	UNIT: mm	SCALE: none	SHEET: 1 of 1	DWG. SIZE: A4	LAYER: bxconn
X.XXX ±0.15	APPROVED: WILL				
GENERAL ANGLE: ±3°					

BXCONN[®]

REV.	DESCRIPTION	ECN NO.	NAME	DATE

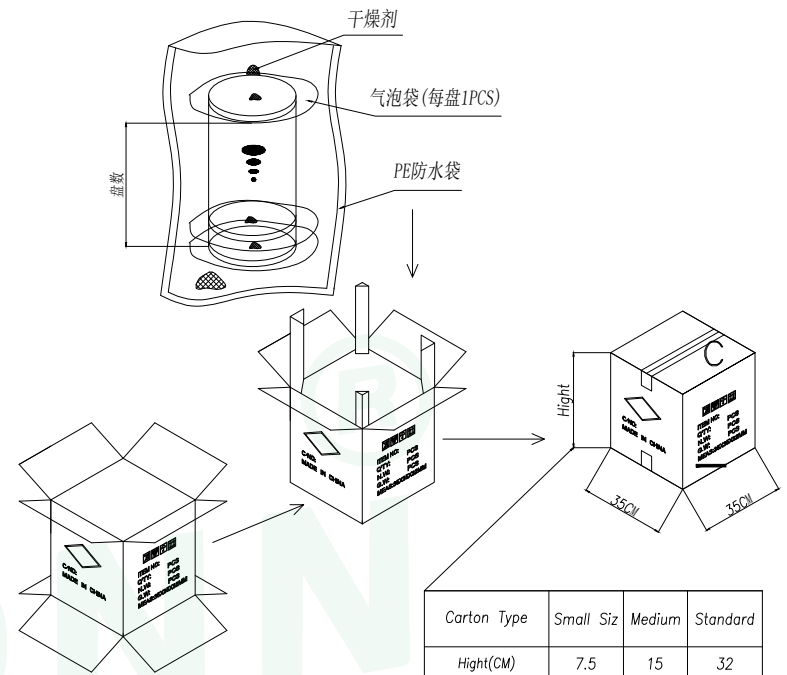
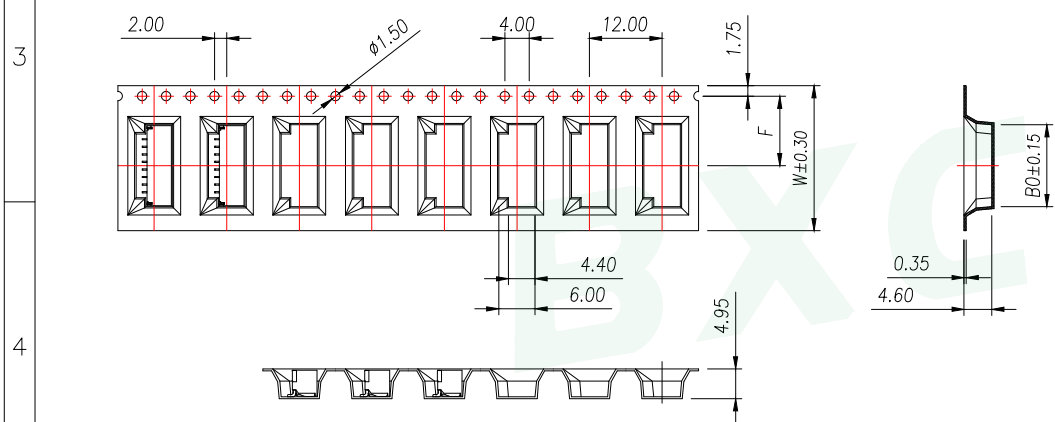
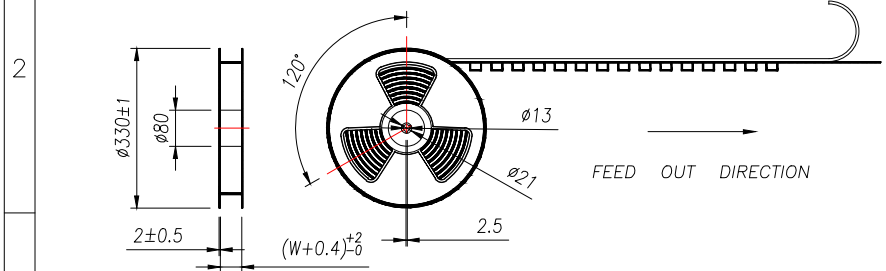
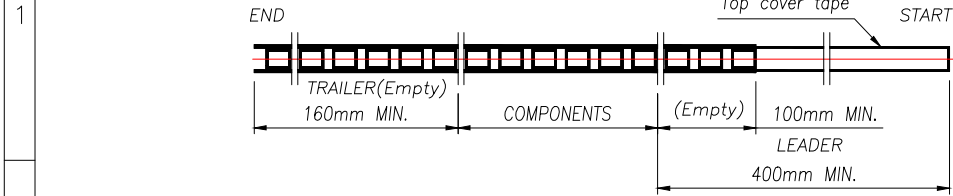

Carton Type	Small Siz	Medium	Standard
Hight(CM)	7.5	15	32

NOTE:
 1.10 SPROCKET HOLE PITCH CUMULATIVE TOLERANCE ± 0.2 mm.
 2.CARRIER CAMBER NOT TO EXCEED 1mm IN 100mm.
 3.ALL DIMENSIONS MEET EIA-481 REQUIREMENTS.
 4.MATERIAL: CLEAR ANTISTATIC PS, COLD SEALING.
 5.THICKNESS: 0.35 ± 0.05 mm.
 6.PACKING LENGTH PER REEL: 12.4 METERS.
 7.COMPONENT LOAD PER REEL: 1000 PCS.

PIN	NO.	Dim B0	Dim W	Dim F	PCS/RELL	RELL/CARTON	PCS/CARTON
2	WF-1F125B2P	8.20	16	7.5	1000	14	14000
3	WF-1F125B3P	10.20					
4	WF-1F125B4P	12.20					
5	WF-1F125B5P	14.20					
6	WF-1F125B6P	16.20	24	11.50		10	10000
7	WF-1F125B7P	18.20					
8	WF-1F125B8P	20.20					
9	WF-1F125B9P	22.20					

GENERAL TOLERANCE		DONGGUAN BAOXUN PRECISION TECHNOLOGY CO., LTD			
DIM.	TOL.	TITLE: 线对板针座 GH1.25 卧式贴片			
X		DWG. NO.: WF-1F125BNP		DRAWN: MAX	
X.X	± 0.30	PART NO.: WF-1F125BNP		CHECKED: ELLA	
X.XX	± 0.25	UNIT: mm		APPROVED: WILL	
X.XXX	± 0.15	SCALE: none	SHEET: 1 of 1	DWG. SIZE: A4	LAYER: bxconn
GENERAL	ANGLE: $\pm 3^\circ$				



REV.	DESCRIPTION	ECN NO.	NAME	DATE

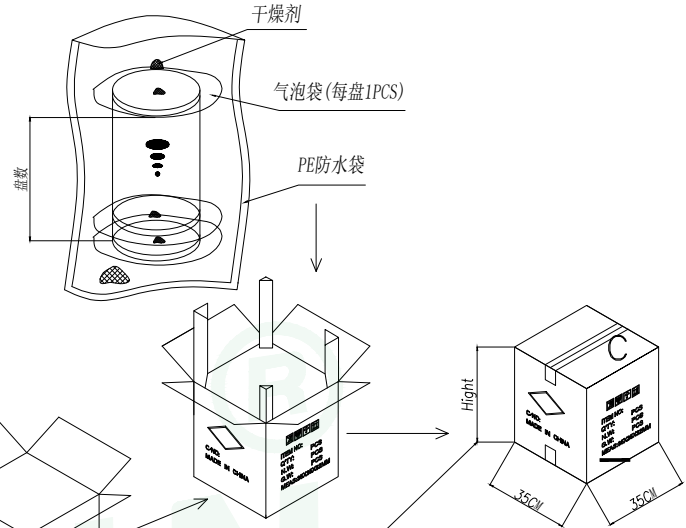
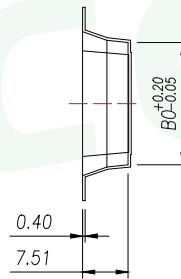
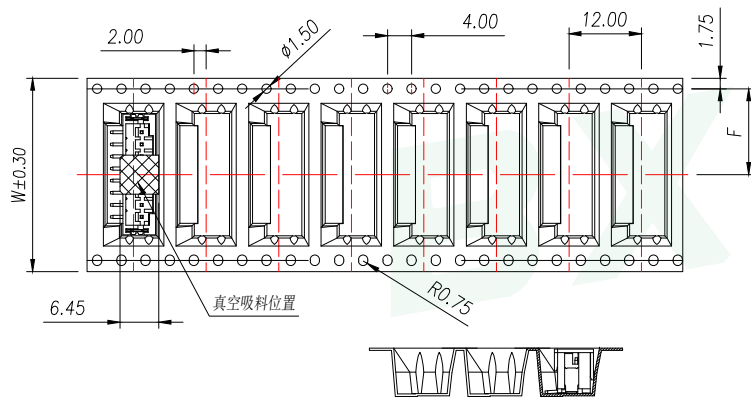
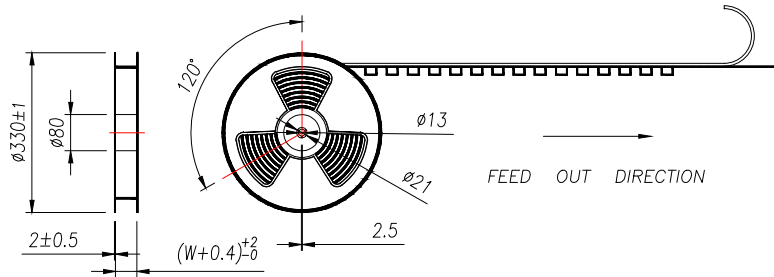
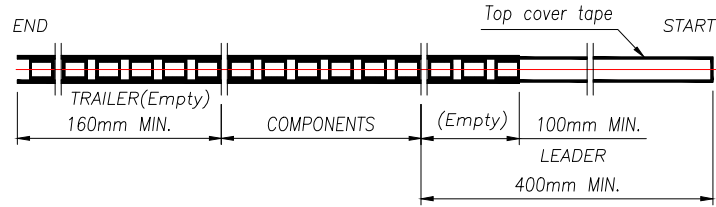

Carton Type	Small Siz	Medium	Standard
Hight(CM)	7.5	15	32

- NOTE:
- 1.10 SPROCKET HOLE PITCH CUMULATIVE TOLERANCE $\pm 0.2\text{mm}$.
 - 2.CARRIER CAMBER NOT TO EXCEED 1mm IN 100mm.
 - 3.ALL DIMENSIONS MEET EIA-481 REQUIREMENTS.
 - 4.MATERIAL: CLEAR ANTISTATIC PS, COLD SEALING.
 - 5.THICKNESS: $0.35 \pm 0.05\text{mm}$.
 - 6.PACKING LENGHT PER REEL: 12.4 METERS.
 - 7.COMPONENT LOAD PER REEL: 1000 PCS.

PIN	NO.	Dim BO	Dim W	Dim F	PCS/RELL	RELL/CARTON	PCS/CARTON
10	WF-1F125B10P	16.05	32	14.2	1000	8	8000
11	WF-1F125B11P	17.30					
12	WF-1F125B12P	18.55					
13	WF-1F125B13P	19.80					
14	WF-1F125B14P	21.05	44	20.2	6	6000	
15	WF-1F125B15P	22.30					
16	WF-1F125B16P	23.55					

GENERAL TOLERANCE		DONGGUAN BAOXUN PRECISION TECHNOLOGY CO., LTD				
DIM.	TOL.	TITLE: 线对板针座 GH1.25 卧式贴片				
X		DWG. NO.: WF-1F125BNP		DRAWN: MAX		
X.X	± 0.30	PART NO.: WF-1F125BNP		CHECKED: ELLA		
X.XX	± 0.25	UNIT: mm		APPROVED: WILL		
X.XXX	± 0.15	SCALE: none	SHEET: 1 of 1	DWG. SIZE: A4	LAYER: bxconn	
GENERAL ANGLE:	$\pm 3^\circ$					