

JIS1608 [EIA 0603]

[NTCG164LH104HTDS](#)

- ▶ UL certificate/E250289
- ▶ Max. Temp. 125°C
- ▶ Automotive Grade
- ▶ Compliant with AEC-Q200



Dimension and Construction

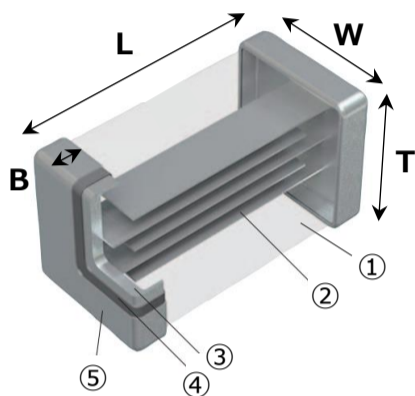

Symbol	Dimension
L	1.6±0.1mm
W	0.8±0.1mm
T	0.8±0.1mm
B	0.2mm min.

No.	Name
①	Semiconductor ceramics
②	Internal electrode
③	Base electrode
④	Ni plating
⑤	Sn plating

Electrical Characteristics

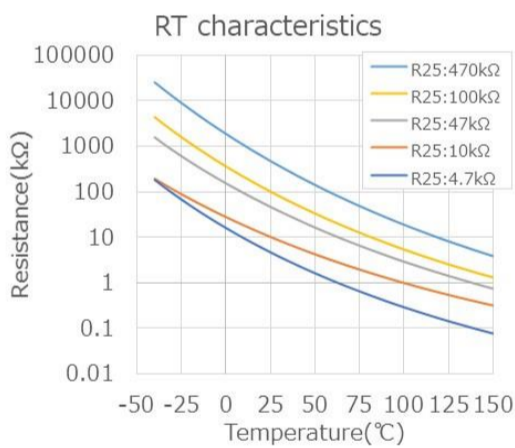

Item	Specification
Resistance	[at 25°C] 100kΩ±3%
B value	[at 25/50°C] 4485K typ. [at 25/85°C] 4550K±3%
Max. Rated power	[at 25°C] 100mW
Thermal Dissipation Constant	[at 25°C] 1mW/°C
Permissible Operating Current	[at 25°C] 0.1mA
Max. Voltage	5V
Operating Temperature	-40°C~125°C
1degC Step Data	[-40°C~125°C] Link

Package



Item	Specification
Packing	Taping (Paper carrier)
Reel Dimension	φ180mm
Packing Quantity	4,000pcs/reel
Weight	0.0050g