

# 产品规格书

## SPECIFICATION FOR APPROVAL

产品名称 Description	半导体激光器件
产品型号 Part No	DRS680-0005-0008-2121E
制作日期 Date	2023-08-15

制作 Producer	工程部 Engineering Dept.	业务部 Business department	批准 Approval
张均	谭尚军	欧阳松	陈明祥

客户承认结果 Customer acknowledges Results		



## 外观 Exterior:

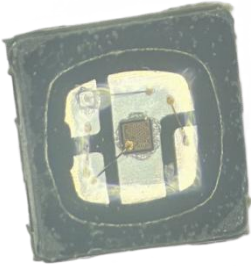

## 产品构造 Product conformation:

- 封装: 2121 封装  
Packaging glue: 2121 encapsulation
- 发光颜色: 红光 波长 680nm  
Luminous color: red wavelength 680nm
- 芯片规格: 8mil\*8mil  
Chip specification: 8mil\*8mil
- 发光角度: 22 度  
Luminous Angle: 20 degrees
- 静电敏感材质  
Electrostatic sensitive material



**ATTENTION**  
OBSERVE PRECAUTIONS  
FOR HANDLING  
ELECTROSTATIC  
DISCHARGE  
SENSITIVE  
DEVICES

注意: 操作时请注意静电敏感  
释放设备装置

产品外形尺寸 Package outline dimensions:

Top view

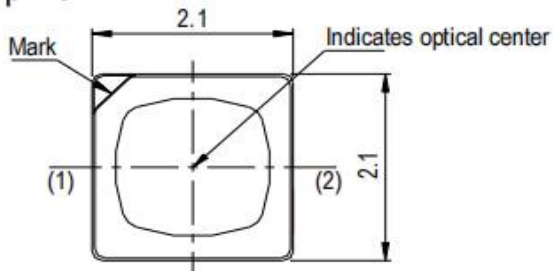

Side view

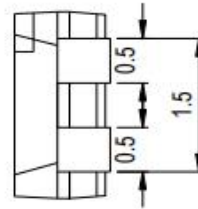

Side view

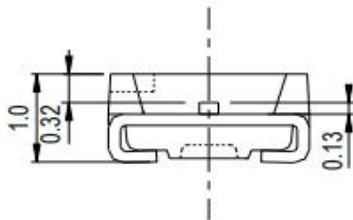

Polarity

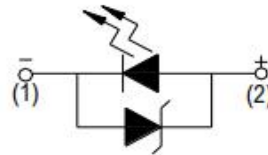

Bottom view

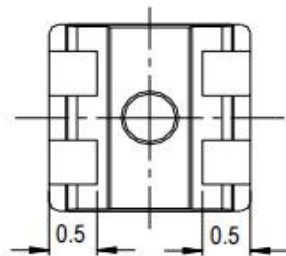

备注(Note):

1. 标注尺寸单位为毫米  
Dimensions are in millimeters.
2. 除特别标注外, 所有尺寸允许公差 $\pm 0.1\text{mm}$ .  
Tolerances unless mentioned are  $\pm 0.1\text{mm}$ .

光电特性 Electrical Optical Characteristics(@25°C)

参数 Parameter	符号 Symbol	单位 Unit	最小 值 Min.	典型 值 Typ.	最大 值 Max	备注 Note
阈值电流 Threshold Current	I <sub>th</sub>	mA		2.6		
正向电压 Forward Voltage	V <sub>f</sub>	V		2.5		IF = 10mA
光功率 Output Power	P <sub>op</sub>	mW	4.0	5		IF = 10mA
斜率效率 Slope Efficiency	SE	W/A	0.55	0.7		
转换效率 Power Conversion Efficiency	PCE	%		20		IF = 10mA
波长 Wavelength	λ <sub>op</sub>	nm	675	680		
发散角 Divergence Angle(1/e <sub>2</sub> )		deg		22		IF = 10mA

25° C, QCW 模式 (pulse length 0.5ms, 1% Duty Cycle )

### L-I-V 性能曲线

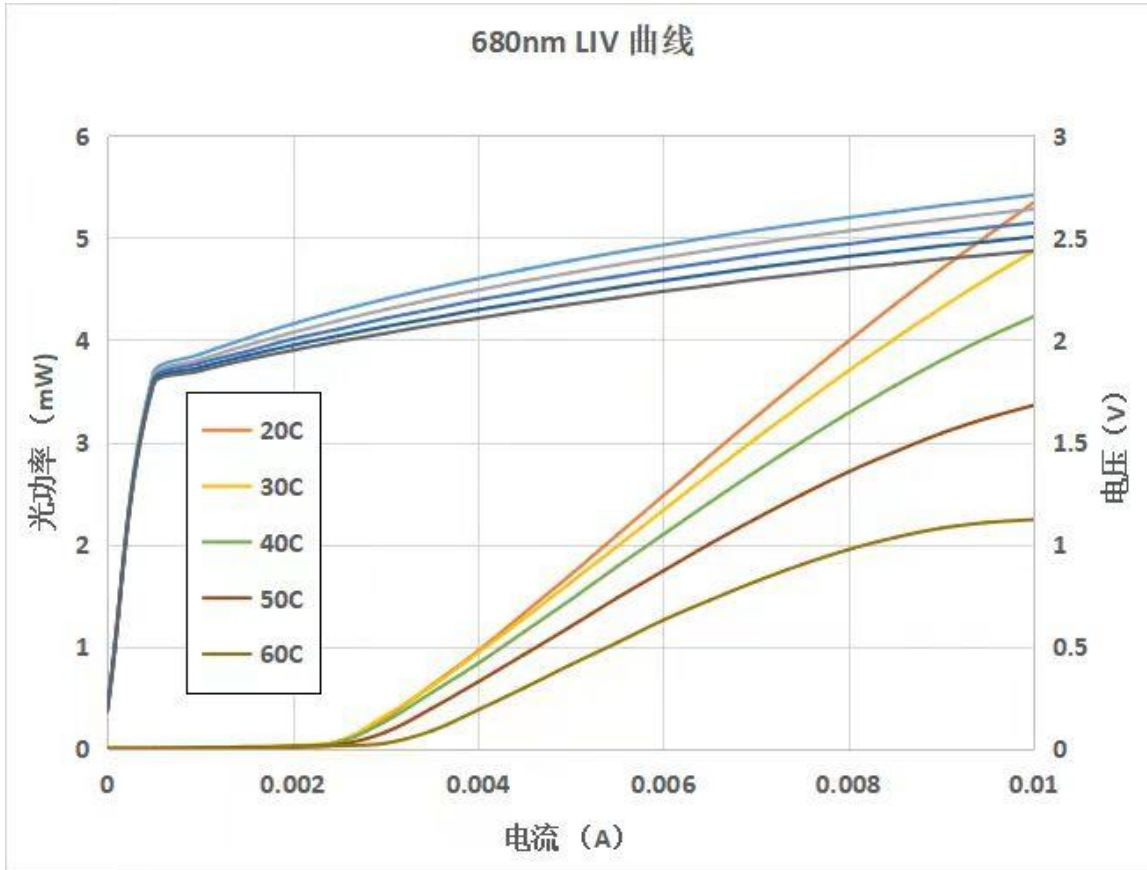

### 光谱

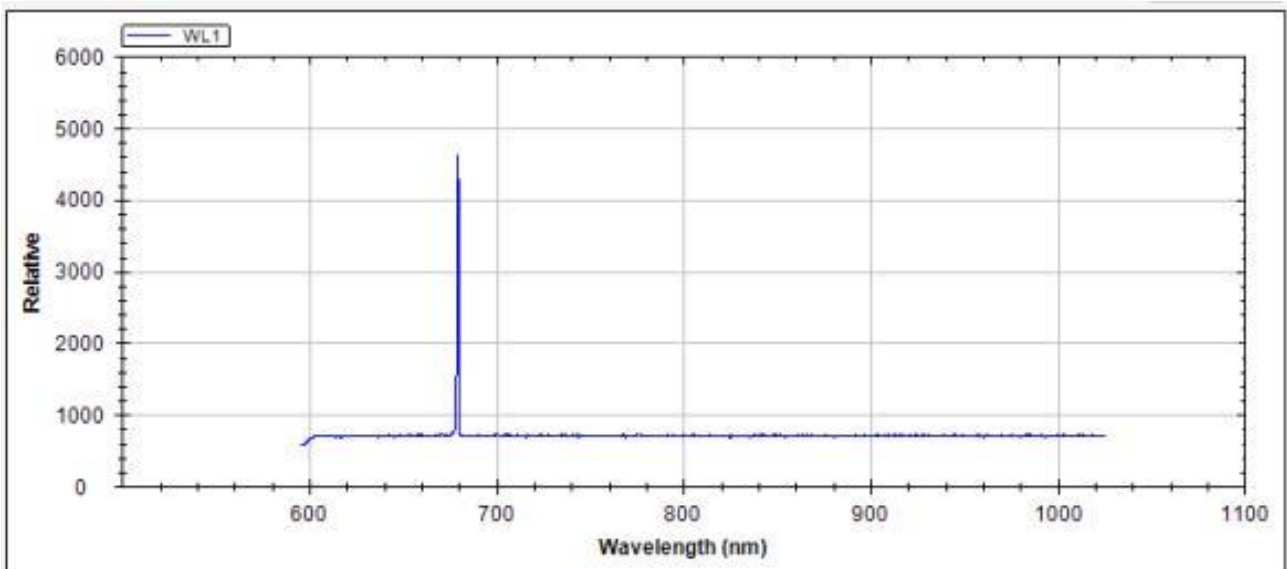

远场发散角 (  $\sim 22^\circ$  at 10mA )

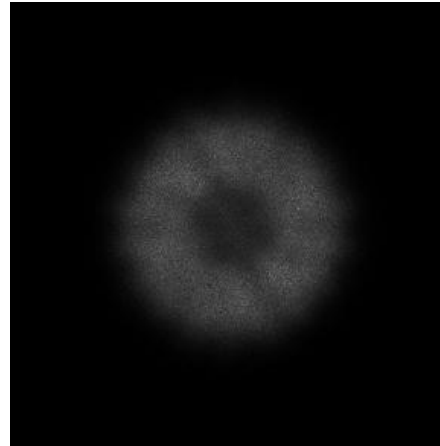
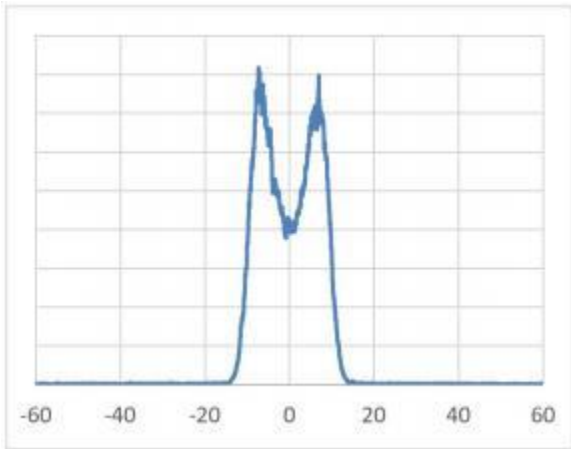

绝对最大额定参数

参数 Parameter	符号 Symbol	单位 Unit	范围
工作温度 Operating Temperature	Topr	°C	-20 ~ +65
存贮温度 Storage Temperature	Tstg	°C	-20 ~ +85

# 卷轴尺寸 Reel Dimensions:

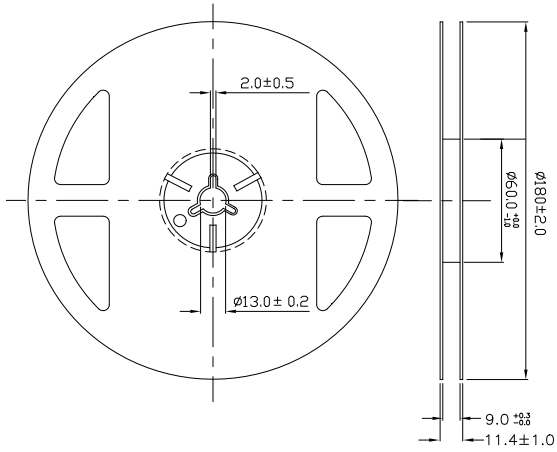

Loaded quantity 3500PCS per reel

## Polarity Direction

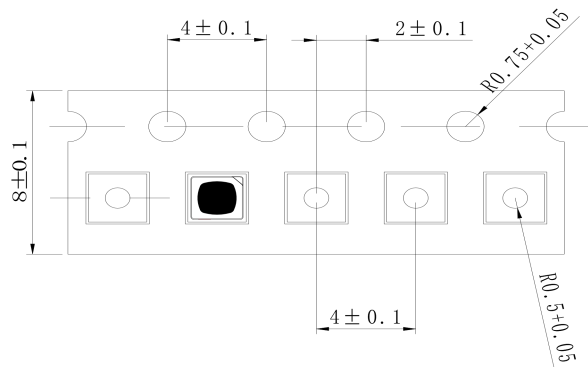
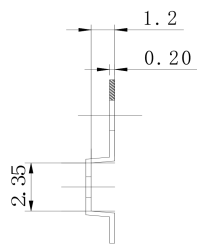
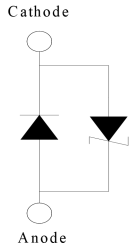

## 应用注意事项 Application precautions:

### 保存及使用 Preservation and use:

1. 在打开包装前，应存放在 30℃/60%RH 或以下的环境中。打开包装后，应置于 20-30℃/30%RH 或以下的环境中使用。  
Before opening the package, it should be stored at 30℃/60%RH or less. After opening the package, it should be placed in an environment of 20-30℃/30%RH or less.
2. molding 封装及 SMD VCSEL 开封后要在 24H 之内使用，为了避免环境的影响，建议拆封后，经过 60℃/24H 除湿，没用完 VCSEL 需及时做抽真空包装处理，避免再次使用时发生失效。  
To avoid the impact of the environment, it is recommended to dehumidify after unpacking at 60℃/24H. All the VCSELs are needed to be vacuumed to avoid failure
3. 若干燥剂褪色或过期使用，需干燥烘烤：60±5℃/24 小时。  
If the desiccant faded or expired use, dry baking: 60±5℃/24 hours.
4. VCSEL 的胶表面易沾灰尘，需要做好相关防尘措施。  
VCSEL Glue surface easy to dust, need to do the relevant dust prevention measures.

### 取放 pick and place

夹取 VCSEL 时只能触及支架体，镊子之类的工具不要对透镜施压。更不要刺或推透镜。

When taking the VCSEL, you should only touch the bracket. Tools such as tweezers should not put pressure on the lens. Don't stab or push the lens.

### 热量处理 Heat treatment

在过大电流驱动时 VCSEL 的 Tj (节点温度) 会超过限制值，这导致 VCSEL 的寿命严重缩短，热量处理措施要有效的减小应用产品的热阻。比较通用的做法：把 VCSEL 封装器件安装在金属基质的 PCB 板上。1W VCSEL 产品要求金属基板的表面散热面积至少 30cm<sup>2</sup> (3W 产品建议 80cm<sup>2</sup> 以上)，且其导热系数要高于 2.0W/mK。VCSEL 和金属基板结合靠导热性较好的导热胶，要求导热系数高于 1.0W/mK，厚度小于 100um。

When driven by excessive current, the Tj (node temperature) of VCSEL will exceed the period limit value, which leads to a serious shortening of VCSEL life. Thermal treatment measures should effectively reduce the thermal resistance of application products. Common practice: install VCSEL packages on metal matrix PCB boards. 1W VCSEL products require the surface heat dissipation area of the metal substrate to be at least 30cm squared (over 80cm squared is recommended for 3W products), and its thermal conductivity is higher than 2.0w /mK. VCSEL and gold substrate are combined by thermal conductive adhesive with good thermal conductivity. The thermal conductivity coefficient is required to be higher than 1.0w /mK and the thickness is less than 100um.

### 清洁 Clean

需要清洁的话，用干净的软碎布沾点酒精轻力擦除异物，不可以采用诸如丙酮之类的清洁剂以免可能造成腐蚀破坏。

If you need to clean, use a clean, soft cloth dipped in alcohol to gently remove foreign matter. Do not use a cleaner such as acetone to avoid possible corrosion damage.

### 电性注意事项 Electrical precautions

1. VCSEL 不允许反向驱动。  
VCSEL Reverse drive is not allowed
2. 限流措施是必要的，否则轻微的电压变化会导致较大的电流变化，可能造成 VCSEL 失效。  
Current limiting measures are necessary, otherwise slight voltage changes will lead to large current changes, which may lead to VCSEL failure.
3. 在发光量满足要求的前提下，推荐采用低于额定电流的驱动电流，这样有利于提高产品的可靠性。  
Under the premise that the luminous quantity meets the requirements, it is recommended to use the drive current lower than the rated current, which is conducive to improving the reliability of the product.

### 防静电措施 anti-static precautions

VCSEL 是静电敏感器件，在保存、使用过程中要采取防静电措施。静电和电涌会导致产品特性发生改变，例如正向电压降低等，情况严重甚至会损毁产品。所以对于整个工序（生产，测试，包装等）与 VCSEL 直接接触的员工都要做好防止和消除静电的措施。所有相关的设备和机器都应该



正确接地。接地交流电阻小于 1.0 欧姆，工作台上需垫表面电阻 106-109 欧姆的桌垫。在容易产生静电的环境和设备上，还必须安装离子风扇。作业过程中，操作员需使用防静电手环，防静电垫子，防静电工作服，工作鞋，手套，防静电容等。

VCSEL is electrostatic sensitive devices, in the process of preservation, use to take anti-static measures. Static electricity and surge can lead to changes in product characteristics, such as forward voltage reduction, which can be serious and even damage the product. So for the whole process (production, testing, packaging, etc.) and VCSEL direct contact staff should do a good job to prevent and eliminate electrostatic measures. All related equipment and machinery should be properly grounded. The grounding ac resistance is less than 1.0 ohm, the table mat with surface resistance of 106-109 ohm is needed on the work table. Ion fans must also be installed in electrostatic environments and equipment. During the operation, the operator should use anti-static bracelet, anti-static mat, anti-static overalls, working shoes, gloves, anti-static capacity.

## 电烙铁焊接 An electric soldering iron

建议使用防静电电烙铁，尖端处温度不超过 350°C，每次焊锡时少于 3 秒。电烙铁的功率宜低于 60W。每焊完一次之后间隔 2 秒以上，分别焊好两个电极引脚。焊接时不可对透镜用力施压。VCSEL 如有问题一般都是从焊锡时开始出现。故必须按要求小心作业。

It is recommended to use anti-static electric soldering iron, the temperature at the tip does not exceed 350°C, less than 3 seconds for each soldering. The power of the soldering iron should be less than 60W. Weld two electrode pins more than 2 seconds after each welding. Do not force the lens during welding. Problems with VCSELs usually begin when they are soldered. So you must work carefully as required.

## SMT 回流焊说明 Reflow instructions

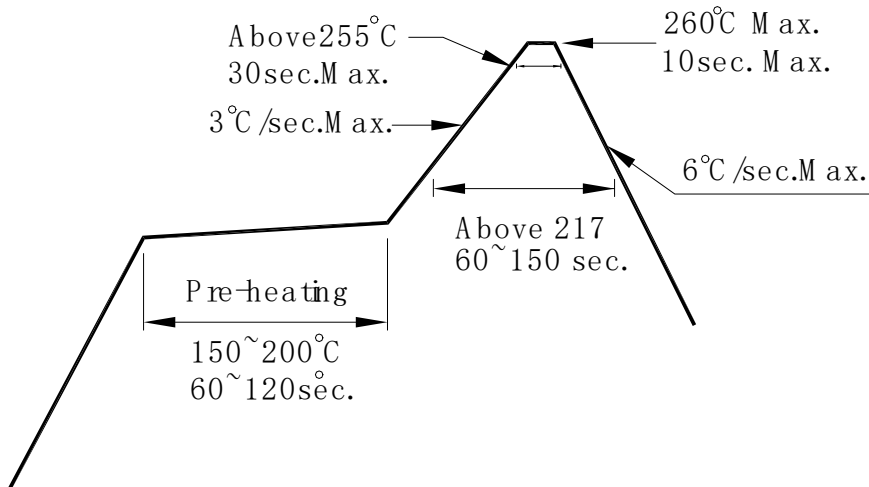

## 注意事项 matters need attention:

- 回流焊只允许做一次。  
Reflow soldering is only allowed once.
- 回流焊过程中不要对灯体施加压力。  
Do not apply pressure to the lamp body during reflow
- 回流焊完成之后不要挤压散热板、不可压到胶体部分。  
After reflow welding is completed, do not press the heat dissipation plate, do not press to the colloidal part.
- 若有比较低熔点的锡膏，TP 可以适当降低。  
If there is a lower melting point of solder paste, TP can be appropriately reduced.