

H3-MACP-011051

5-1225MHz 75Ω 7.5dB Coupler

APPLICATIONS

• Ideally suited for CATV Broadband applications.

FEATURES

- Surface mount
- 7.5dB Coupler
- RoHS compliant and Pb free
- Available on tape and reel

DIMENSIONS

Land Pattern

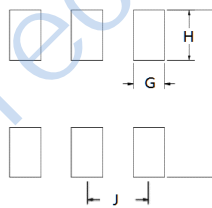
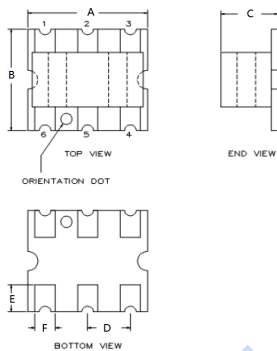

A	B	C
7.11	6.35	3.10
D	E	F
2.54	1.70	1.20

G	H	I
1.30	2.15	6.71
J		
2.54		

Unless otherwise stated dimensions are in mm

Tolerance: .xx ± 0.25, .xxx ± 0.05

ELECTRICAL SPECIFICATIONS@25°C:

Parameters (P#: ENA PORT)	frequency band	Min.	Typ.	Max.	Unit
Port Impedance, Z0(P1/P2/P3/P4)			75/75/75/75		Ohm
Coupling (pin1-3)	5 - 1225 MHz	7.0	7.5	8.5	dB
Main Line Loss (pin1-6)	5 - 1000 MHz		1.7	2.1	dB
	1000 - 1225 MHz		1.9	2.5	dB
Input Return Loss (pin1)	5 - 500 MHz	17	19		dB
	500 - 1225 MHz	12	15		dB
Output Return Loss (pin6)	5 - 500 MHz	17	20		dB
	500 - 1225 MHz	12	14		dB
Coupled Return Loss (pin3)	5 - 50 MHz	17	18		dB
	50 - 1225 MHz	15	17		dB
Isolation	5 - 500 MHz	30	34		dB
	500 - 1225 MHz	17	21		dB

FUNCTIONAL SCHEMATIC

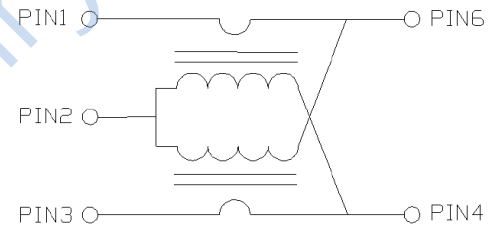

PIN CONFIGURATION

Pin No.	Function
1	Input
2	Ground
3	Coupled
4	Isolated
5	Not Connected
6	Output

APPLICATION & TEST CIRCUIT

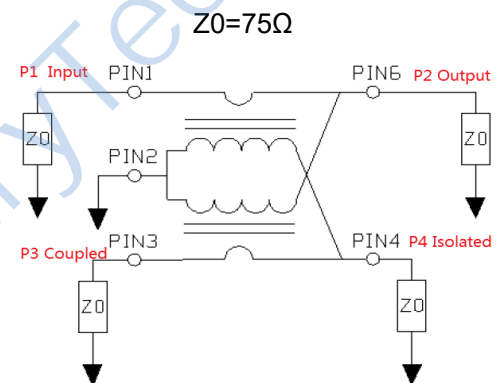

ABSOLUTE MAXIMUM RATINGS

Parameter	Value
Input RF Power	2W Max
DC Current	500mA Max
Operating Temperature Range	-40 to 95°C

Tel: +86-28-85589664

E-mail: mr_li@henglitaitech.com

Web: www.hltchips.com

Address: No.198 Tianqin East Street, Gaoxin West District, Chengdu City

TEST CURVE

Coupling (pin1-3)

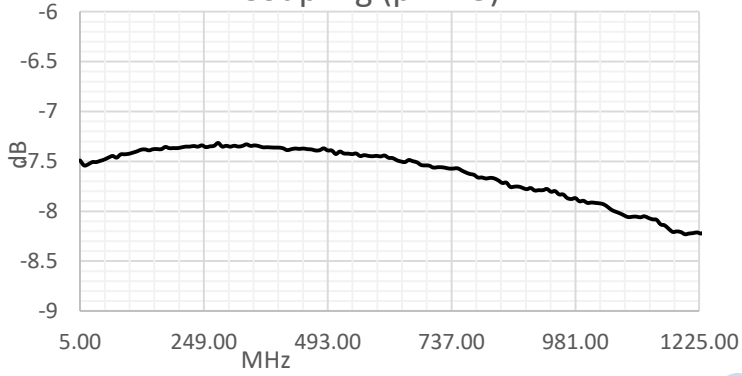

Main Line Loss (pin1-6)

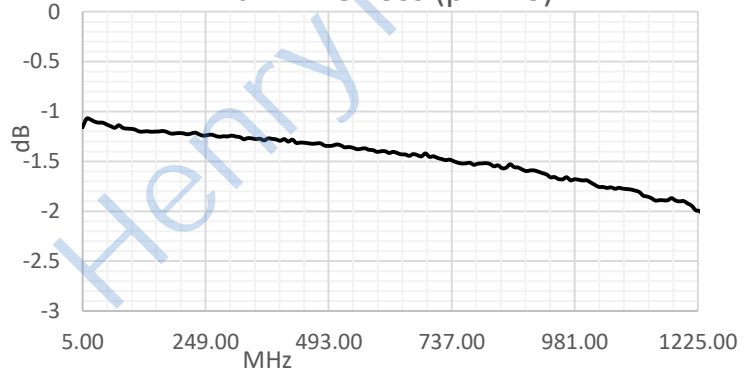

Input Return Loss (pin1)

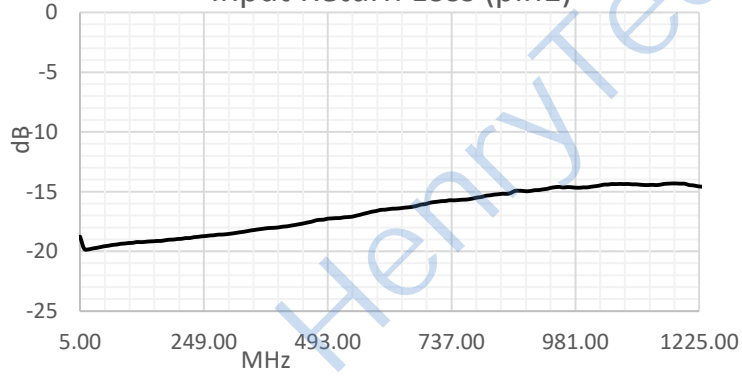

Output Return Loss (pin6)

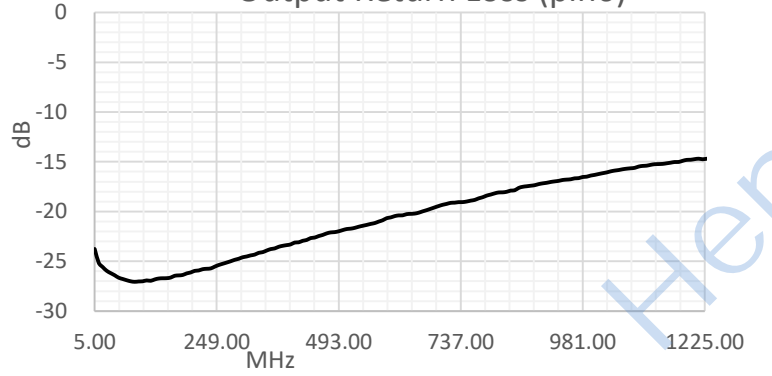

Coupled Return Loss (pin3)

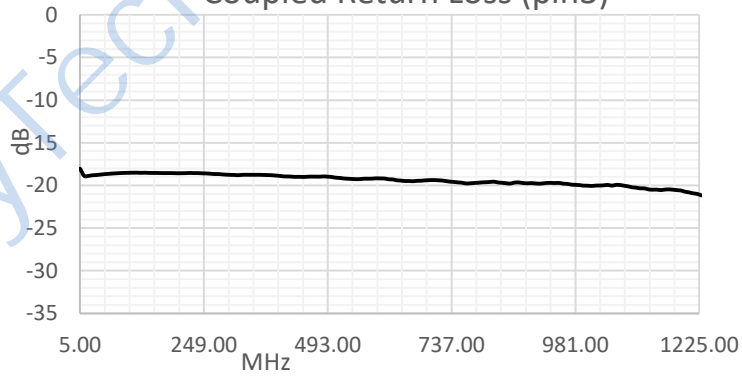

Isolation (pin1-4)

