

H3-MAPDCT0030

5-1000MHz 75Ω 2 Way Power Divider

APPLICATIONS

• Ideally suited for high volume CATV & VSAT applications.

FEATURES

- Surface mount
- 2 Way 0 degree
- 260°C reflow compatible
- RoHS compliant and Pb free
- Available on tape and reel

DIMENSIONS

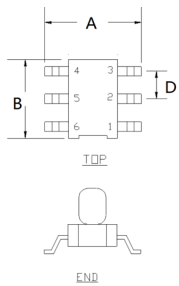

A	B	C
5.33	4.27	4.10 Max
D		
1.50		

Unless otherwise stated dimensions are in mm

Tolerance: .xx ± 0.25, .xxx ± 0.05

PCB LAYOUT

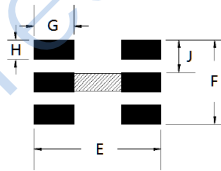

E	F	G
6.13	3.91	1.92
H	J	
0.91	1.50	

FUNCTIONAL SCHEMATIC

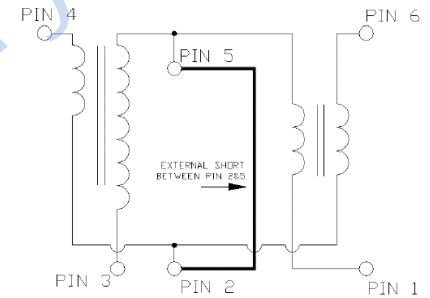

PIN CONFIGURATION

Pin No.	Function
1	Output 1
2	External 1pF Capacitor to ground
3	Ground
4	Input
5	External 1pF Capacitor to ground
6	Output 2

APPLICATION & TEST CIRCUIT

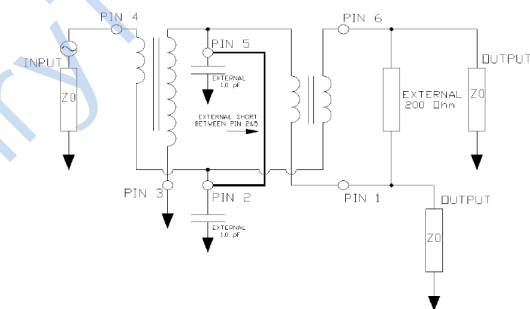

ELECTRICAL SPECIFICATIONS@25°C:

Parameters (P#: ENA PORT)	frequency band	Min.	Typ.	Max.	Unit
Port Impedance, Z0 (P1 / P2 / P3)			75 / 75/ 75		Ohm
Insertion Loss (Above 3dB)	5 - 400 MHz		0.3	0.5	dB
	400 - 820 MHz		0.5	1.1	dB
	820 - 1000 MHz		1.1	2.2	dB
Input Return Loss	5 - 400 MHz	23.0	30.0		dB
	400 - 820 MHz	16.0	22.0		dB
	820 - 1000 MHz	17.0	20.0		dB
Isolation	5 - 400 MHz	18.0	25.0		dB
	400 - 820 MHz	20.0	23.0		dB
	820 - 1000 MHz	14.0	18.0		dB
Amplitude Balance	5 - 400 MHz		0.2	± 0.5	dB
	400 - 820 MHz		0.2	± 0.3	dB
	820 - 1000 MHz		0.6	± 0.9	dB
Phase Balance	5 - 400 MHz		1.5	± 4	°
	400 - 820 MHz		2	± 4	°
	820 - 1000 MHz		1.5	± 6	°

ABSOLUTE MAXIMUM RATINGS

Parameter	Value
Input RF Power	1W Max
Internal Load Dissipation	0.125W Max
Operating Temperature Range	-40 to 85°C

TEST CURVE

Insertion Loss: Pin 4 to Pin 1

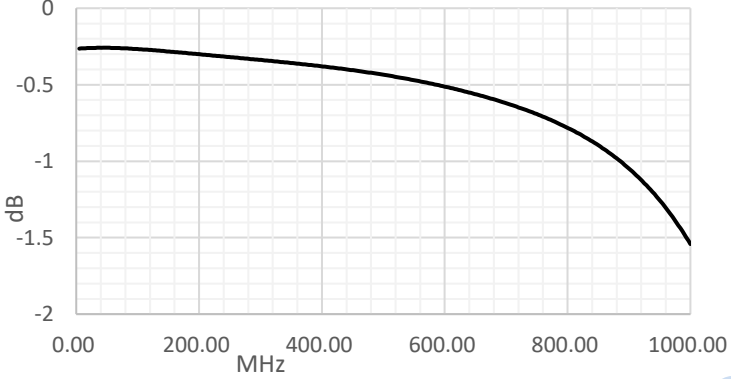

Insertion Loss: Pin 4 to Pin 3

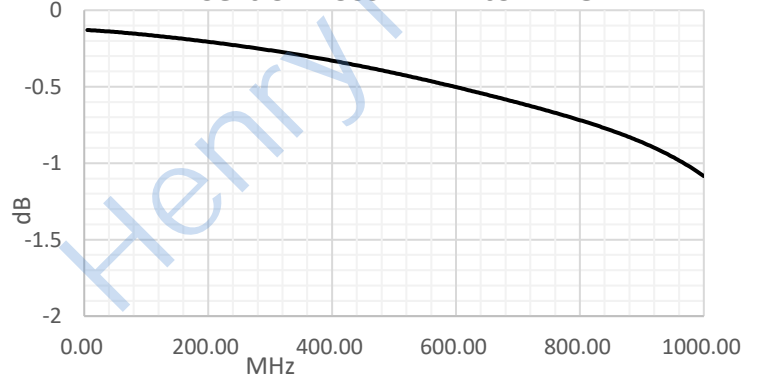

Input Return Loss: Pin 4

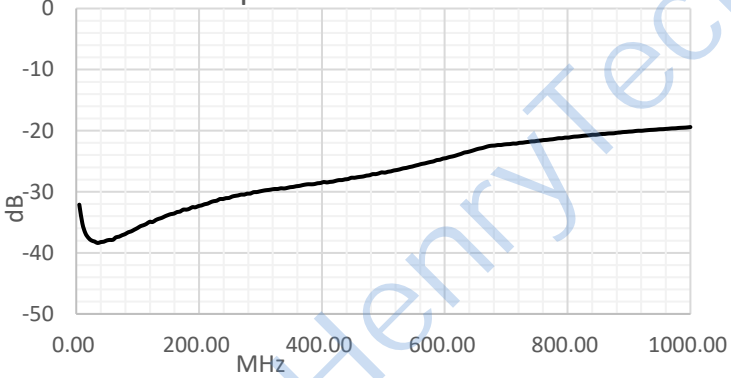

Isolation

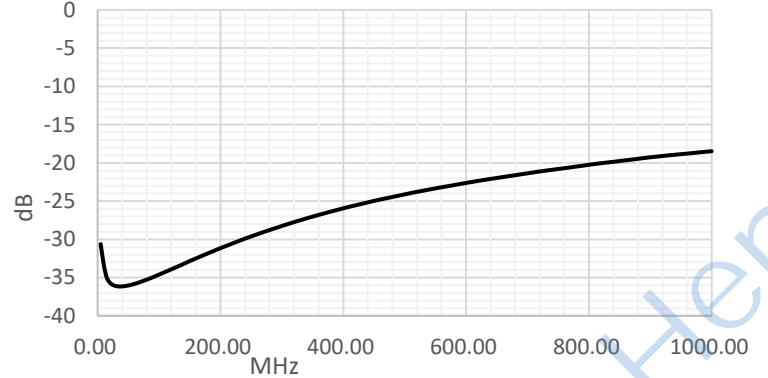

Amplitude Balance

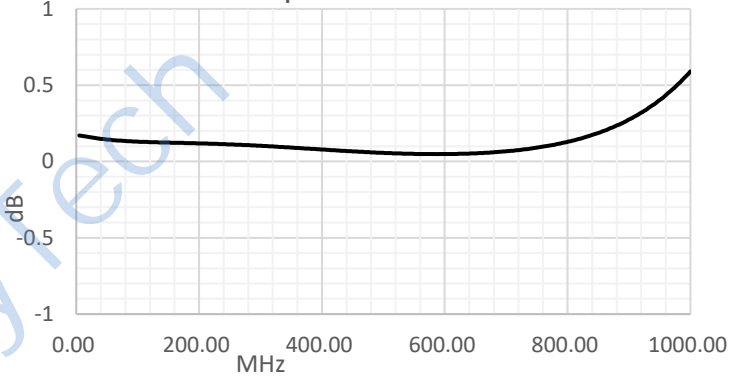

Phase Balance

