

SURFACE MOUNT SCHOTTKY BARRIER RECTIFIER

Features

- ◆ The plastic package carries Underwriters Laboratory Flammability Classification 94V-0
- ◆ For surface mounted applications
- ◆ Metal silicon junction, majority carrier conduction
- ◆ Low power loss, high efficiency
- ◆ Built-in strain relief, ideal for automated placement
- ◆ High forward surge current capability
- ◆ High temperature soldering guaranteed:
250 °C/10 seconds at terminals

SOD-123FL

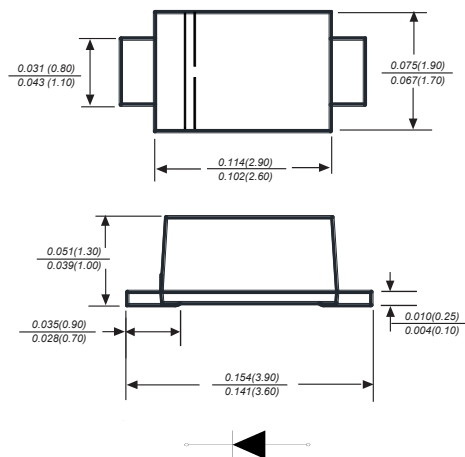

Dimensions in inches and (millimeters)

Mechanical Data

Case: JEDEC SOD-123FL molded plastic body
 Terminals: Solderable per MIL-STD-750, Method 2026
 Polarity: Color band denotes cathode end Mounting
 Position: Any
 Weight: 0.00048ounce, 0.015 grams

Maximum Ratings And Electrical Characteristics

Ratings at 25 °C ambient temperature unless otherwise specified.

Single phase half-wave 60Hz, resistive or inductive load, for capacitive load current derate by 20%.

Parameter	SYMBOLS	DSK22	DSK24	DSK25	DSK26	DSK28	DSK210	DSK215	DSK220	UNITS	
Marking Code		K22	K24	K25	K26	K28	K210	K215	K220		
Maximum repetitive peak reverse voltage	V_{RRM}	20	40	50	60	80	100	150	200	V	
Maximum RMS voltage	V_{RMS}	14	28	35	42	56	70	105	140	V	
Maximum DC blocking voltage	V_{DC}	20	40	50	60	80	100	150	200	V	
Maximum average forward rectified current at TL (see fig.1)	I_{AV}	2.0								A	
Peak forward surge current 8.3ms single half sine-wave superimposed on rated load (JEDEC Method)	I_{FSM}	50								A	
Maximum instantaneous forward voltage at 2.0A	V_F	0.55	0.70			0.85		0.95		V	
Maximum DC reverse current $T_A=25^{\circ}C$ at rated DC blocking voltage $T_A=125^{\circ}C$	I_R	0.5				0.3				mA	
		5.0				3.0					
Typical junction capacitance (NOTE 1)	C_J	220			80						pF
Typical thermal resistance (NOTE 2)	$R_{\theta JA}$	85.0								°C/W	
Operating junction temperature range	T_J	-55 to +150								°C	
Storage temperature range	T_{STG}	-55 to +150								°C	

Note: 1. Measured at 1MHz and applied reverse voltage of 4.0V D.C.

Typical Characteristics

Fig.1 Forward Current Derating Curve

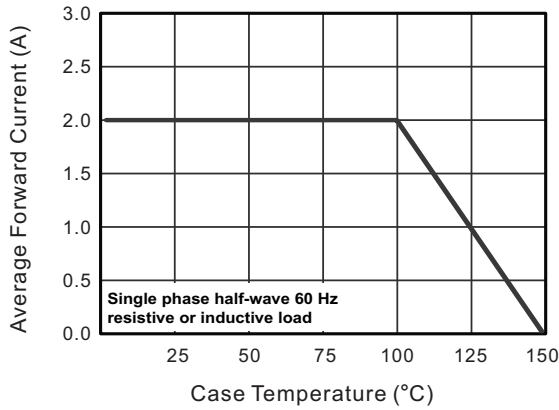

Fig.2 Typical Reverse Characteristics

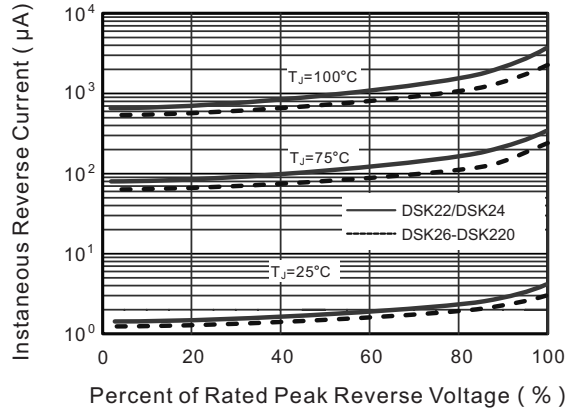

Fig.3 Typical Forward Characteristic

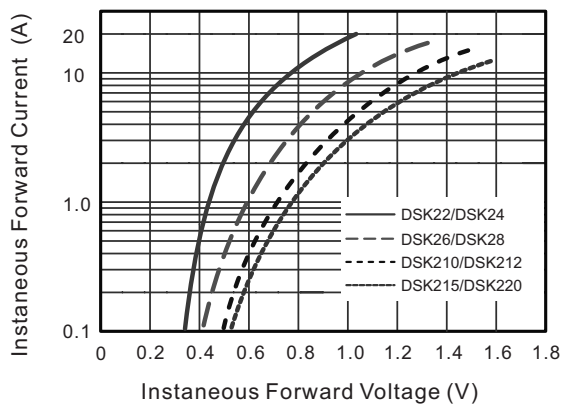

Fig.4 Typical Junction Capacitance

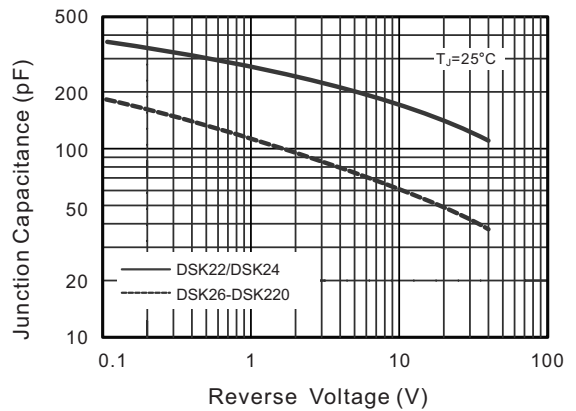

Fig.5 Maximum Non-Repetitive Peak Forward Surge Current

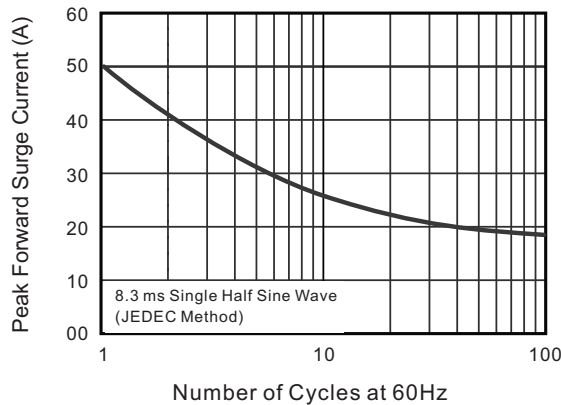
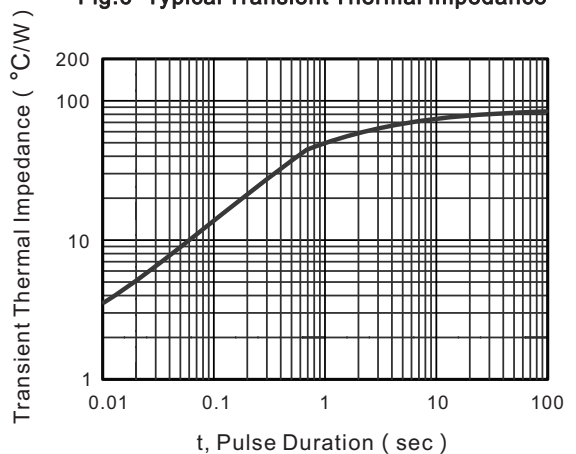
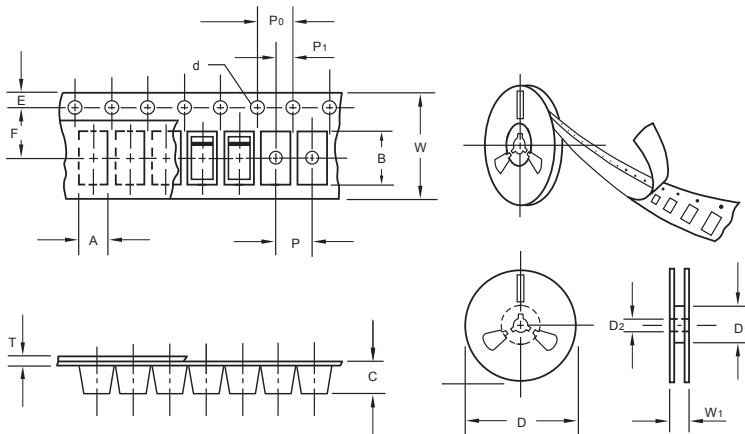

Fig.6- Typical Transient Thermal Impedance



The curve above is for reference only.

Packing information



unit:mm

Item	Symbol	Tolerance	SOD-123FL
Carrier width	A	0.1	2.1
Carrier length	B	0.1	4.0
Carrier depth	C	0.1	1.60
Sprocket hole	d	0.05	1.55
7" Reel outside diameter	D	2.0	178.00
7" Reel inner diameter	D1	min	50.0
Feed hole diameter	D2	0.5	13.00
Sprocket hole position	E	0.1	1.75
Punch hole position	F	0.1	3.50
Punch hole pitch	P	0.1	4.00
Sprocket hole pitch	P0	0.1	4.00
Embossment center	P1	0.1	2.00
Overall tape thickness	T	0.1	0.25
Tape width	W	0.3	8.15
Reel width	W1	1.0	10.5

Note: Devices are packed in accordance with EIA standard RS-481-A and specifications listed above.

Reel packing

PACKAGE	REEL SIZE	REEL (pcs)	COMPONENT SPACING (m/m)	BOX (pcs)	INNER BOX (m/m)	REEL DIA, (m/m)	CARTON SIZE (m/m)	CARTON (pcs)	APPROX. GROSS WEIGHT (kg)
SOD-123FL	7"	3,000	4.0	45,000	210*208*203	178	430*430*235	180,000	9.0

Suggested Pad Layout

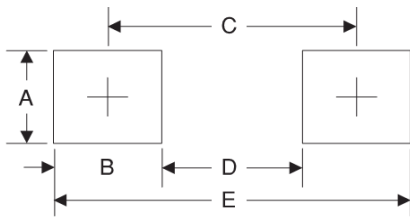

Symbol	Unit (mm)	Unit (inch)
A	1.2	0.047
B	1.2	0.047
C	3.2	0.126
D	2	0.079
E	4.4	0.173