

Description:

This N-Channel MOSFET uses advanced trench technology and design to provide excellent $R_{DS(on)}$ with low gate charge. It can be used in a wide variety of applications.

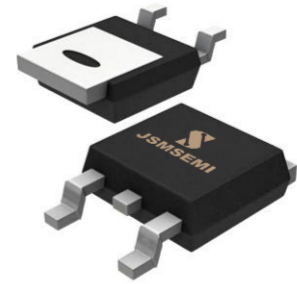

TO-252

Features:

- 1) $V_{DS}=100V, I_D=15A, R_{DS(ON)} < 100m\Omega @ V_{GS}=10V$
- 2) Low gate charge.
- 3) Green device available.
- 4) Advanced high cell density trench technology for ultra $R_{DS(ON)}$.
- 5) Excellent package for good heat dissipation.

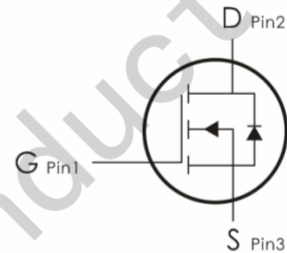

Absolute Maximum Ratings: ($T_C=25^\circ C$ unless otherwise noted)

Symbol	Parameter	Ratings	Units
V_{DS}	Drain-Source Voltage	100	V
V_{GS}	Gate-Source Voltage	± 20	V
I_D	Continuous Drain Current- $T_C=25^\circ C$	15	A
	Continuous Drain Current- $T_C=70^\circ C$	12	
	Pulsed Drain Current ¹	60	
E_{AS}	Single Pulse Avalanche Energy	16	mJ
P_D	Power Dissipation, $T_C=25^\circ C$	50	W
T_J, T_{STG}	Operating and Storage Junction Temperature Range	-55 to +150	$^\circ C$

Thermal Characteristics:

Symbol	Parameter	Max	Units
$R_{\theta JC}$	Thermal Resistance, Junction to Case	3	$^\circ C/W$
$R_{\theta JA}$	Thermal Resistance, Junction to Ambient	---	

Electrical Characteristics: ($T_C=25^\circ\text{C}$ unless otherwise noted)

Symbol	Parameter	Conditions	Min	Typ	Max	Units
Off Characteristics						
BV_{DSS}	Drain-Source Breakdown Voltage	$V_{GS}=0V, I_D=250\ \mu\text{A}$	100	---	---	V
I_{DSS}	Zero Gate Voltage Drain Current	$V_{GS}=0V, V_{DS}=80V$	---	---	1	μA
I_{GSS}	Gate-Source Leakage Current	$V_{GS}=\pm 20V, V_{DS}=0A$	---	---	± 100	nA
On Characteristics						
$V_{GS(th)}$	GATE-Source Threshold Voltage	$V_{GS}=V_{DS}, I_D=250\ \mu\text{A}$	1	2	3	V
$R_{DS(on)}$	Drain-Source On Resistance ³	$V_{GS}=10V, I_D=10A$	---	75	100	m Ω
		$V_{GS}=4.5V, I_D=8A$	---	100	115	
G_{FS}	Forward Transconductance	$V_{DS}=0V, I_D=0A$	---	---	---	S
Dynamic Characteristics						
C_{iss}	Input Capacitance	$V_{DS}=25V, V_{GS}=0V, f=1\text{MHz}$	---	890	---	pF
C_{oss}	Output Capacitance		---	60	---	
C_{rss}	Reverse Transfer Capacitance		---	25	---	
Switching Characteristics						
$t_{d(on)}$	Turn-On Delay Time ³	$V_{DD}=25V, I_D=8A,$ $V_{GS}=10V, R_{GEN}=1\Omega$	---	14.2	---	ns
t_r	Rise Time ^{2,3}		---	34	---	ns
$t_{d(off)}$	Turn-Off Delay Time		---	40.4	---	ns
t_f	Fall Time ^{2,3}		---	6	---	ns
Q_g	Total Gate Charge ³	$V_{GS}=10V, V_{DS}=80V,$ $I_D=10A$	---	24	---	nC
Q_{gs}	Gate-Source Charge		---	5	---	nC
Q_{gd}	Gate-Drain "Miller" Charge		---	8	---	nC
Drain-Source Diode Characteristics						
V_{SD}	Source-Drain Diode Forward Voltage ³	$V_{GS}=0V, I_S=8A$	---	0.8	1.2	V

Trr	Reverse Recovery Time	ISD=8A, VGS=0V di/dt=100A/μs	---	35	---	Ns
qrr	Reverse Recovery Charge		---	121	---	nc

Notes:

- ① Pulse width limited by maximum allowable junction temperature
- ② Limited by TJmax, starting TJ = 25°C, L = 0.1mH, RG = 25Ω, IAS = 18A, VGS = 10V. Part not recommended for use above this value
- ③ Pulse width ≤ 300μs; duty cycle ≤ 2%.

Typical Characteristics: (Tc=25°C unless otherwise noted)

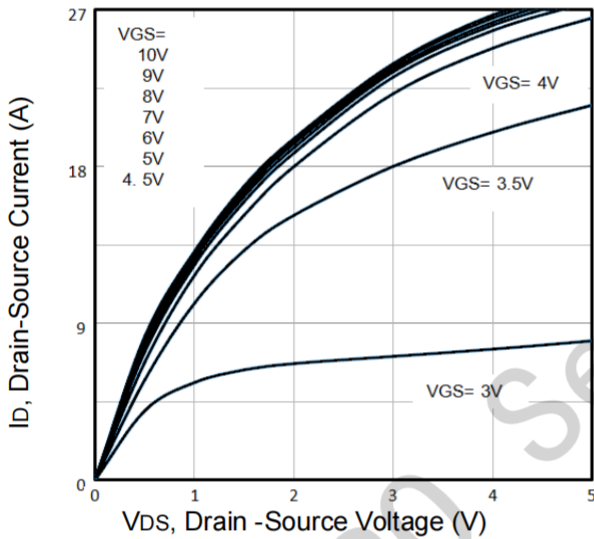

Fig1. Typical Output Characteristics

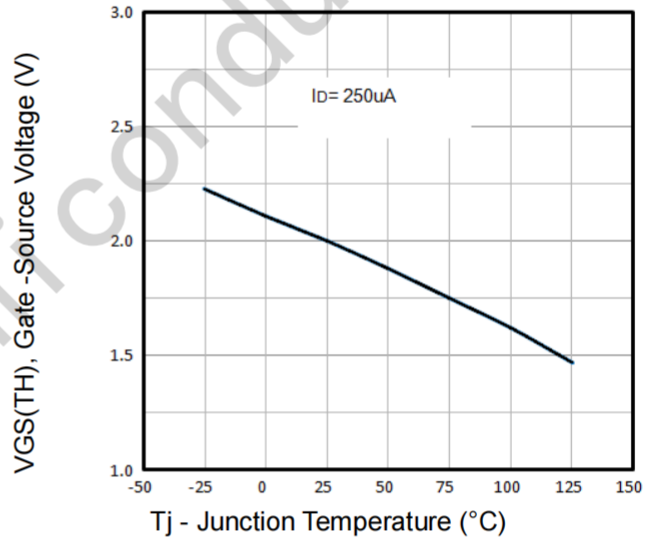

Fig2. VGS(TH) Voltage Vs. Temperature

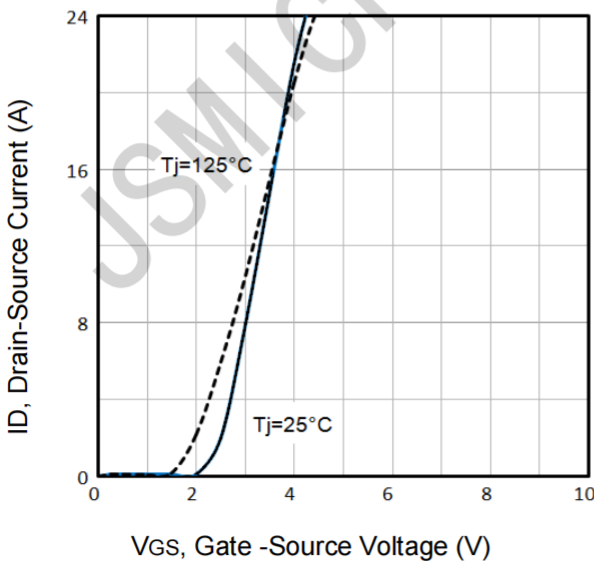

Fig3. Typical Transfer Characteristics

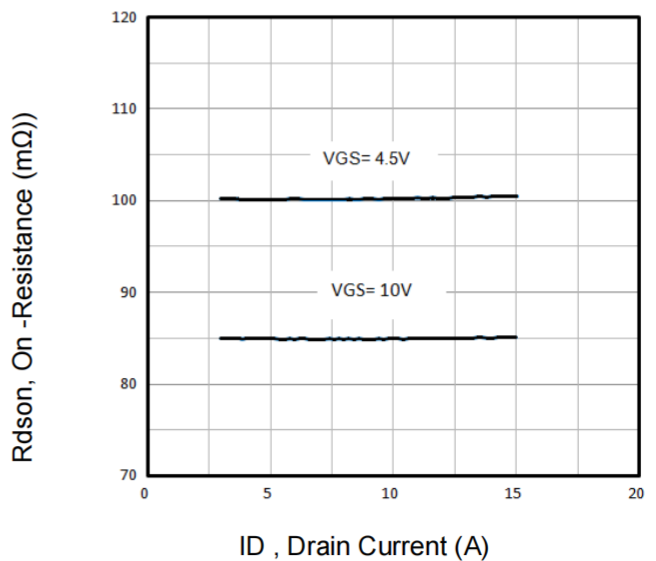

Fig4. On-Resistance vs. Drain Current and Gate Voltage

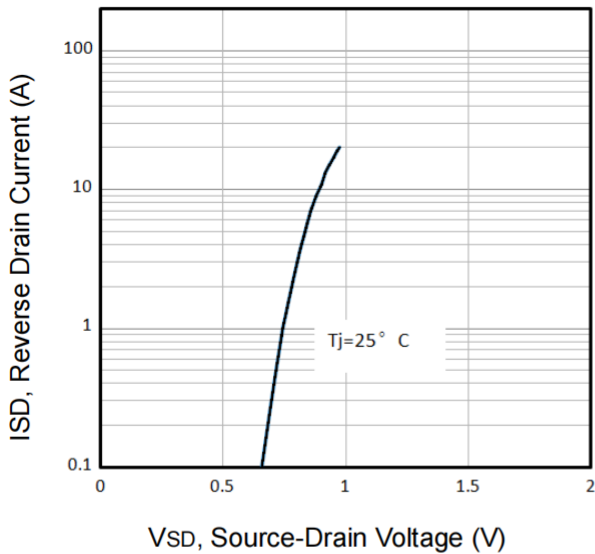

Fig5. Typical Source-Drain Diode Forward Voltage

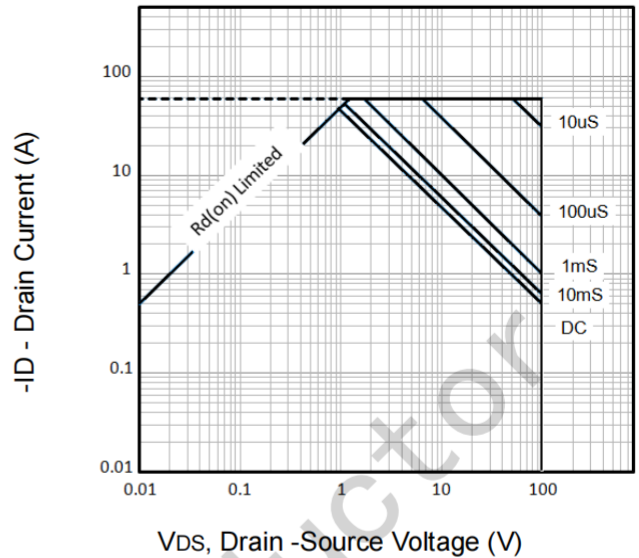

Fig6. Maximum Safe Operating Area

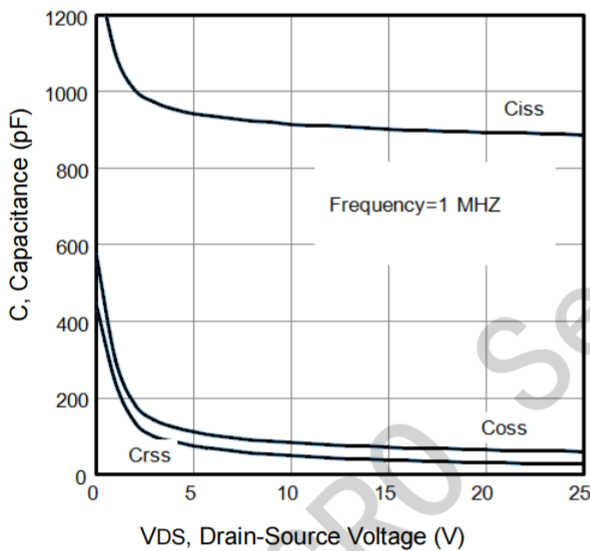

Fig7. Typical Capacitance Vs. Drain-Source Voltage

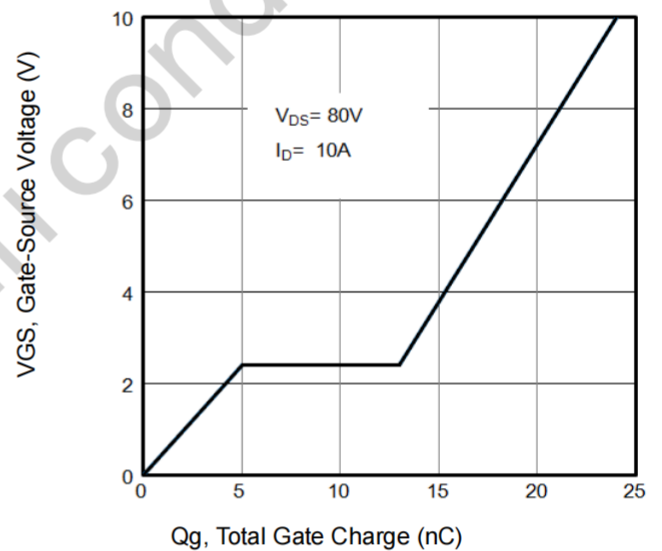

Fig8. Typical Gate Charge Vs. Gate-Source Voltage

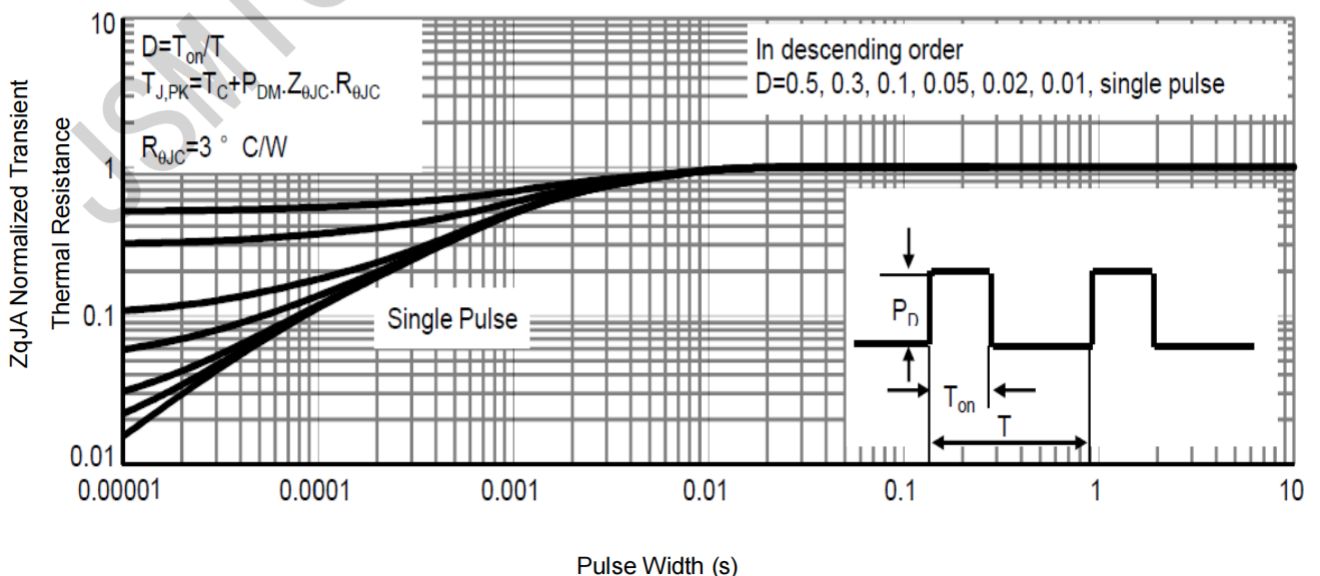
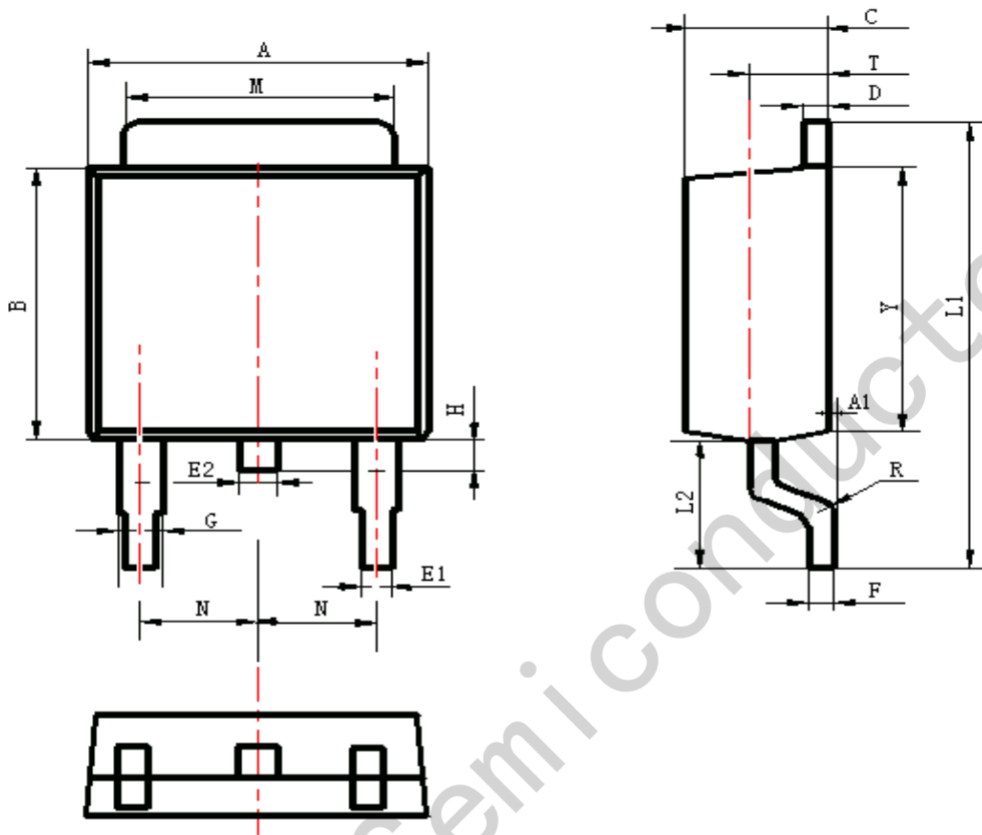

Fig9. Normalized Maximum Transient Thermal Impedance

Package Information

TO-252



Symbol	Dimensions In Millimeters		Dimensions In Inches	
	Min.	Max.	Min.	Max.
A	6.30	6.90	0.248	0.272
A1	0.00	0.16	0.000	0.006
B	5.70	6.30	0.224	0.248
C	2.10	2.50	0.083	0.098
D	0.30	0.70	0.012	0.028
E1	0.60	0.90	0.024	0.035
E2	0.70	1.00	0.028	0.039
F	0.30	0.60	0.012	0.024
G	0.70	1.20	0.028	0.047
L1	9.60	10.50	0.378	0.413
L2	2.70	3.10	0.106	0.122
H	0.40	1.00	0.016	0.039
M	5.10	5.50	0.201	0.217
N	2.09	2.49	0.082	0.098
R	0.30		0.012	
T	1.40	1.60	0.055	0.063
Y	5.10	6.30	0.201	0.248